

The Repeater

Second Edition



Richard Watkins

© Copyright 2011, 2017, Richard Watkins

Parts 1 to 6 of this book were first published as a series of articles in the NAWCC Bulletin from 2009 to 2011. Part 7 was added in 2017.

Cover Photograph: The dial of the Ellicott decimal repeater which is described in Part 6 (© 2011 Arndt Simon).

In addition to adding Part 7, I have made changes and corrections throughout the book.

This book has been designed for double-sided (duplex) printing and contains some blank pages.

Contents

Acknowledgements	v
Repeater Videos	vi
Chapter 1: The Continental Quarter Repeater	1
Preliminary remarks	1
Illustrations	1
Continuous motion and discrete states	2
The repeater-train and striking hours	2
Quarter striking and the order of striking	4
Counting the hours and quarters	4
Operating the hammers	5
Simple but useless!	7
The all-or-nothing piece	8
The hour-pallet large-hammer lifting pin	9
The star-wheel and jumper	9
The surprise-piece	13
Strike timing	16
Hand Setting	18
Chapter 2: Development of the Quarter Repeater	21
Pieces, mechanisms and calibres	21
The modern quarter-repeater	22
The modern simplified quarter-repeater	23
Half-quarter and five-minute repeaters	26
State transitions, timing and hand setting	30
Chapter 3: Minute Repeaters	31
The minute repeater	31
A simplified minute repeater	34
Minute repeater freedom mechanisms	36
State transitions and hand setting	39
Chapter 4: The Quarter Repeaters of Stogden and Breguet	41
Introduction	41
The motion work and snails	42
Striking	43
All-or-nothing mechanism release	44
Hour and half-quarter counting	45
Striking and locking the all-or-nothing mechanism	46
Half-quarter-snail freedom and accuracy	47
Hour-snail freedom and accuracy	47
Strike timing	50
Hand setting	50
Breguet's half-quarter repeater	51

Chapter 5: The IWC Minute Repeater	55
Introduction	55
Going train and motion work	55
Overview	56
Winding and the repeater train	58
The quarter and hour snails	58
Hour and quarter striking	59
Minute counting and striking	60
All-or-nothing mechanism	61
Minute strike control	62
The repeater-spring arbor	64
Strike timing	64
The isolator	65
Freedom and accuracy mechanisms	66
12 hours 30 minutes	67
12 hours 29 minutes	68
12 hours 59 minutes	70
Hand setting	70
Chapter 6: The Decimal Repeater	73
Time units	73
The decimal repeater	73
A reverse history	73
Ellicott, Arnold and Breguet	75
Breguet's minute repeater	76
Examples of striking	78
General principles	80
Strike timing	81
Freedom and accuracy	81
Arnold's decimal repeater	81
Ellicott's decimal repeater	84
Chapter 7: The Grande Sonnerie Clock-Watch	89
Basic principles	89
Striking	90
Automatic release	90
Silencer	91
Manual release	92
Suppression of hour striking	93
The minute-rack stop	93
Hand setting	94

Acknowledgements

I would like to thank Stephen Katchur who made several invaluable suggestions which have greatly improved this series of articles.

Part 5, *The IWC Repeater*, could not have been written without the help I received from Romy Hebden, Public Relations Manager for IWC Schaffhausen, and Olivia Fraude, Corporate Communications, IWC Schaffhausen. In particular, for one and a half years Romy Hebden showed extraordinary patience in dealing with my requests and questions. Many requests were passed on to IWC engineers so that I could get detailed information. Unfortunately I do not know the names of these people, but their cooperation was essential.

Also, I would like to thank Stefan Weeber. He tested his own IWC repeater many times to check my interpretation of the mechanism and provided me with sound files of it striking.

Part 6, *The Decimal Repeater*, could not have been written without the help of two people. First, Jean-Michel Piguet, of the Musée International d'Horlogerie, La Chaux-de-Fonds, arranged the examination and photographs of Arnold's decimal repeater. Second, Arndt Simon spent many hours producing photographs and videos of Ellicott's decimal repeater, and he provided invaluable information about it. And I thank Kari Voutilainen for providing and allowing me to use the photograph of his decimal repeater.

Part 7 was written as the result of a suggestion by Milán Bikics that I should include clock-watches and he provided information on the patent from which some drawings were taken.

The illustrations have been derived from the following sources:

Antiquorum: *The Art of Breguet*, 1991 (Figures 94, 137 and 138).

Antiquorum: *L'Art de l'Horlogerie en France*, 1993 (Figure 136).

Baillie: *Watches, their History, Decoration and Mechanism*, 1929 (Figures 27-28 and 41).

Berthoud: *Essai sur l'Horlogerie*, 1763 (Figures 36 and 37).

Jean-Pierre Dalloz: *Patent EP1429214A1, Pièce d'horlogerie munie d'un mécanisme de sonnerie*, available from <https://www.google.com.na/patents/EP1429214A1?cl=fr> (Figures 162-166)

Daniels: *The Art of Breguet*, 1974 (Figures 96 and 97).

Fritz, *The Grande Complication by IWC*, Edition Stemmler, 1991 (Figures 101-104, 106-124, and 129-134).
Reproduced with the permission of the International Watch Company, Schaffhausen Switzerland, and Manfred Fritz.

Hillmann: *La Réparation des Montres Compliquées*, 4th edition, c1926 (Figures 5, 29-30, 39, 64 and 70). Relevant parts of Hillmann's book have been translated into English in Seibel and Hagans *Complicated Watches*.

International Watch Company (Figures 100 and 105). Provided by and reproduced with the permission of the International Watch Company, Schaffhausen, Switzerland.

Lecoultré, *A Guide to Complicated Watches*, 1952 (Figures 22, 40, 42-43, 49-50, 59, 63, 71, 76, 95, 167-171).
Reproduced with permission of Editions Antoine Simonin, Rue des Saars 99 - CH 2007 Neuchâtel.

Musée International d'Horlogerie, La Chaux-de-Fonds (Figures 146-149 and 151-153).

David Penney (Figure 54).

Rees, *The Cyclopaedia or Universal Dictionary of Arts, Sciences, and Literature*, 1820 (Figures 1, 3-4, 6-21, 23-26, 34-35, 77-91 and 98-99).

Saunier: *A Treatise on Modern Horology*, 1861 (Figure 38).

Arndt Simon (Figures 154-161 and cover).

Thiout: *Traite de l'Horlogerie Mecanique et Pratique*, 1741 (Figures 44 and 58).

Kari Voutilainen (Figure 135).

The illustrations have been re-arranged and altered to suit my purposes.

All other illustrations are by the author.

Repeater Videos

Three videos of repeaters striking have been produced for use in conjunction with this book and Crespe's "Essay on Repeater Watches" (www.watkinsr.id.au/crespe.html):

- (a) The continental quarter repeater. This is the old design that uses a chain to operate the repeater from the pendant.
- (b) The minute repeater. This is of a modern design from a circa 1900 watch.
- (c) The decimal repeater. A design from a circa 1747 watch that counts in ten minute intervals instead of the usual 15 minute intervals.

These videos are available from www.watkinsr.id.au/repeaterVid.html in both MP4 and AVI formats.

Chapter 1: The Continental Quarter Repeater

Preliminary remarks

Although only a small book, François Crespe's *Essai sur les Montres à Répétition* has 284 pages and not one illustration. It has sat in my bookcase for many years and I have occasionally wondered how anyone could write so much on such a technical topic without at least one drawing. And I have also wondered how important or irrelevant his book may be compared with other writing on repeaters.

In 2001 I translated *Essai sur les Montres à Répétition* into English and this translation, *Essay on Repeater Watches*, is available from my web site www.watkinsr.id.au. I discovered that this book, published in 1804, is not superficial and descriptive. It is a comprehensive, detailed explanation of how to make and repair repeater-work. But it was written for experienced workmen who already had the skills to make a watch by hand and who were familiar with the quarter repeater. (The methods of making watches at this time are described in Berthoud and Auch *How to Make a Verge Watch* and Vigniaux *Practical Watchmaking*, also available from www.watkinsr.id.au.) Consequently, Crespe had no need to include illustrations of mechanisms, of which his readers had detailed knowledge, and no need to discuss how they worked. His sole aim was to teach workmen the finer arts of making them.

To improve my knowledge, I examined other books which discuss quarter repeaters. Although many books make passing reference to them, only a few treat them in sufficient depth. Most importantly, I found that all were inadequate and most contain errors. So to clarify my understanding and to help others I have written this book.

The repeater is by far the most complex mechanism that can be added to a watch, and even the simple quarter repeater has more than 65 screws, springs, levers, wheels and other parts. Every one of these parts has a precise shape, size, position and function, and every one is essential to the correct behaviour of the mechanism.

Simply naming and describing these parts will give us no idea of how they work. To make matters worse, some parts serve multiple functions and their names can be misleading because they suggest only one of these functions. For example, the quarter-rack has seven distinct features which perform three separate functions, and to do these tasks it must interact with eight other parts of the repeater. So instead of describing the pieces it is necessary to describe the *mechanisms* in which they participate. Consequently, I will examine different parts of the quarter-rack (and other pieces) in different places as we learn about the various functions and mechanisms in a repeater.

In order to understand these mechanisms, it is not enough to just read about them; it is necessary to appreciate how the parts *move* and *interact*. Having a repeater (with the mechanism exposed) is a great help, but it is not necessary. A repeater is a machine and there is nothing magical about it. So, with a little effort, it is possible to visualise how positions change and pieces interact, from initial activation to the end of striking.

Every time you look at an illustration, don't just look at the static position shown, but visualise the parts moving. To start with we will concentrate on only a few pieces. But later it will be necessary to imagine nearly every part moving simultaneously, and this takes practice.

Many different designs for repeaters and clock-watches have been created. A very good source of information is Origami, *Brevets Montres à Sonnerie* (2 volumes) which gives details of 233 patents covering the period 1850 to 1960.

Illustrations

To make it easier to understand the behaviour of such a large number of parts, some illustrations are repeated, highlighting the parts relevant to the aspect of the mechanism being described. Except where explicitly stated, all illustrations show the repeater-work from the dial side. Most of the mechanism is mounted under the dial with the normal motion work; such under-dial work is generally called the *cadranure*, from *cadran*, the French word for dial. But part of it is mounted within the movement, between the pillar and top plates; this includes the hammers, hour striking work and the repeater-spring barrel. For example, Figure 4 is a view of the between-plate pieces from the dial side, looking through a transparent plate, and so the positions and the directions of movement of the parts is the same as in the other illustrations. Most between-plate illustrations are from this view point.

At the end of this chapter (page 19) there are 3 illustrations of the complete under-dial work of two repeaters. Figures 34 and 35, which show the repeater at rest and ready to strike, form the basis for most of the other illustrations in this chapter. These show the positions of the components at 4h 38m 30s; the positions of the hands are shown faintly in outline. Figure 36 shows a different repeater ready to strike. Figure 37 shows some of the pieces of that repeater in perspective, but it must be noted that this view is from underneath (the movement top-plate side).

The Continental Quarter Repeater

Continuous motion and discrete states

Watchmakers expend much effort on devising ways to change continuous motion into discrete steps. Escapements are an obvious example and the repeater is another, where the repeater mechanism converts the continuous motion of the hands into a number of discrete movements of hammers sounding on bells or gongs. A more common and less complex example is a calendar mechanism for displaying dates. In all such cases we attempt to build a *state mechanism* that accurately recognises certain states of the machine and then performs some action unique to that state. (Note that the chronograph is not a state mechanism because it displays the continuous motion of the watch.)

Not that watchmakers thought about such things; they were just trying to find practical solutions to problems. But for us, looking back, it is useful to understand the conceptual basis for their inventions.

A machine moving continuously can be in any one of an infinite number of different positions, albeit for an extremely small time; and so there is no clear, distinct division between two positions. There is not an instantaneous transition but a *movement* from one state to the next, and the boundary between them is blurred by mechanical realities; such as the accuracy with which parts are made, necessary play in bearings and wear over time. In addition, any state mechanism we construct, to perform some action in response to a state, must take time to complete its task. But during this time the machine or watch continues to run and may move past the point which represented that state and onto the next state. Consequently the state mechanism, while it is performing its task, cannot interfere with the machine; any interference may affect the way the machine runs or even stop it completely. The reverse is also true and the machine should not interfere with the state mechanism.

In many cases the state mechanism is totally under the control of the machine and its activation at state transitions is automatic; the striking mechanism in clocks is the obvious example. The mechanic is then in full control and can design the machine and its state mechanism to function correctly.

However, the repeater is a state mechanism which can be activated at the whim of the operator, arbitrarily at any time. Because the mechanic cannot control its activation, a state mechanism must be designed which not only behaves correctly but which cannot be put out of order or synchronisation. Count wheel striking in clocks fails in this regard because it is easy to set it out of synchronisation with the hands.

The repeater is the most sophisticated and complex state mechanism. In it, a hand-made mechanism subject to play and wear must somehow unambiguously distinguish between radically different states which are separated by seconds. The most critical state change is the transition from 12 hours 59 minutes 59 seconds to 1 hour when, in an instant, the mechanism must change from striking at least 15 times to striking just once.

The purpose of this chapter is to explain how the quarter repeater works and, most importantly, to examine how it successfully converts the continuous motion of the watch into the correct, discrete states which we hear.

The repeater-train and striking hours

The basic idea of a repeater is quite simple. All that is involved is a mechanism to cause two hammers to strike the correct time, sounding a low note for each hour and a pair of high-low notes for each quarter. (Early repeaters used a bell, wire gongs were not used until about 1790, and the hour and quarter strikes were distinguished by loudness. The large, heavy hammer is used for the hours and pairs of soft-loud blows by the small and large hammers for the quarters. Later repeaters with gongs have two hammers of the same size.)

Pressing on the *push-piece*, Figure 1 **A**, causes the *winding-rack B-C-D* to swivel around its pivot-point **B** and pull the *chain e*, which turns the *chain-pulley z* anti-clockwise and winds the *repeater-spring*; the only function of the *fixed pulley E* is to make this movement act in the right direction.

The *repeater-spring*, which has only 3 or 4 turns, is mounted in a fixed barrel screwed to the inside of the top plate, Figure 2. Unlike a mainspring, the outer end of the *repeater-spring* is often hooked to the outside of the barrel and passes through a slit in the barrel wall.

The barrel-arbor passes through the pillar plate and has the *chain-pulley z* and the *quarter-rack gathering-pallet r* squared onto it under the dial (Figure 1). Pressing on the push-piece turns the chain-pulley, the quarter-rack gathering-pallet and the barrel-arbor anti-clockwise. This winds the *repeater-spring* less than one turn and so the chain-pulley only needs a single groove. When the push-piece is released and the repeater runs, the *repeater-spring* unwinds, turning the chain pulley clockwise and pulling the push piece back to its original position.

The *first wheel Z* of the *repeater-train*, its *click-work u-v* (Figure 3) and the *hour-rack G* (Figures 2 and 4) are mounted between the repeater barrel and the pillar plate. The ratchet wheel **v** and the hour rack **G** are squared onto the barrel-arbor, and turn anti-clockwise with it when the push-piece (Figure 1 **A**) is pressed. (As indicated in Figures 3 and 4, the hour rack **G** can be screwed to the ratchet **v**. This rack must be very accurately aligned with the hour-pallet to ensure correct striking, and by using screws instead of a square hole, the rack can be aligned and then the ratchet marked, drilled and threaded.)

The Continental Quarter Repeater

However, the wheel **Z** is loose on the barrel-arbor, so that during winding the click **u** slips over the ratchet teeth **v** and the wheel does not rotate; it is only when the repeater-spring unwinds clockwise that this wheel is rotated by the click. So the click-work allows the spring to be wound up anti-clockwise without affecting the repeater-train.

When pressure is released and the spring runs down, pulling the push-piece back up, the *repeater-train*, Figure 4 **Z-s-t**, is driven by the click-work. This train, mounted between the plates with the hammers and the hour striking mechanism, simply regulates the speed of unwinding. It ends with the *delay t*, a pinion mounted in an eccentric bush so that its depthing with the previous wheel can be altered (Figure 5). By varying the depthing, the friction on the train can be altered and its speed controlled. Later repeaters use an escapement or a centrifugal fly instead of the delay.

As noted above, the *hour-rack*, Figure 4 **G**, is squared onto the repeater-spring barrel-arbor. Before pressing the push-piece, the part without teeth is opposite the *hour-pallet 3-4*. Pressing the push-piece rotates the hour-rack anti-clockwise until some of its teeth move past the hour-pallet, as in Figure 4. As the train runs down the teeth of hour-rack, rotating clockwise, trip the hour-pallet **3-4** causing the *large-hammer R* to rise and drop, so striking the hours. (The pallet will be described later.) Figure 4 shows the position after one of the four hours has been struck, and the hammer **R** has been lifted up by the pallet **3-4** ready to strike the next hour.

Note that this figure is wrong because the hour-rack only has 10 teeth for 10 hours!



Figure 1

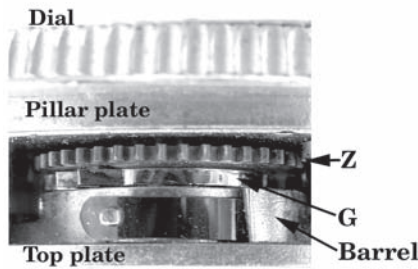

Figure 2

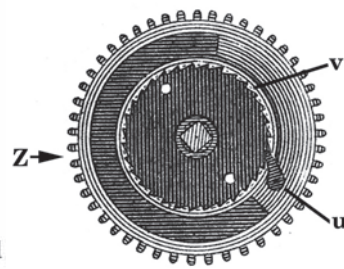

Figure 3

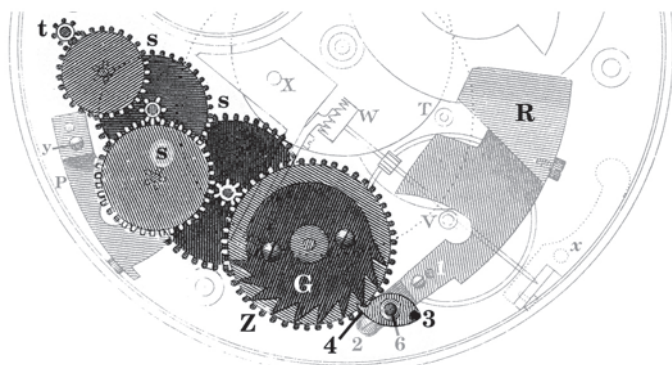

Figure 4

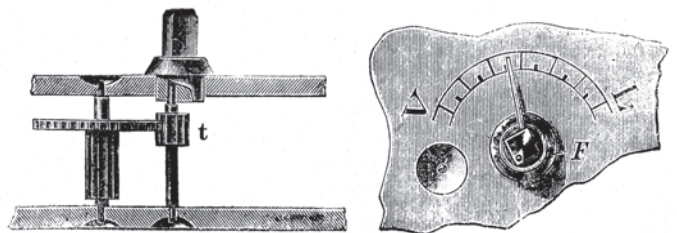

Figure 5

Quarter striking and the order of striking

The hour-rack **G** causes the hours to strike before the quarters. It is a ratchet with 24 teeth, but 12 are removed so that half of it has no teeth and cannot trip the hour-pallet.

When the repeater is at rest, before the push-piece is pressed, the blank (toothless) half of the hour-rack is opposite the hour-pallet **3-4** and the teeth of *quarter-rack*, Figure 6 **L** and **N**, are held away from the quarter-pallets **O** and **Q** by the *quarter-rack gathering-pallet* **r** pressing on the *quarter-rack driving-pin* **k** mounted on the quarter-rack.

Activating, by pressing the push-piece, rotates the hour-rack anti-clockwise so that its blank half and then some of its teeth move past the hour-pallet. At the same time the *quarter-rack gathering-pallet*, Figure 7 **r**, rotates away from the quarter-rack driving pin **k**, and the quarter-rack drops because of the pressure of the *quarter-rack drop-spring* **f** (rotating anti-clockwise around its pivot **M**) and some of its teeth move past the quarter-pallets **O** and **Q**; in this case two teeth to strike the two quarters of 4h 38m.

When the push-piece is released and the repeater-spring runs down, the hour-rack trips the hour-pallet some number of times. Then the hour-rack continues rotating, with the blank part not touching the hour-pallet, until it returns to its rest position.

At the same time, the quarter-rack gathering-pallet **r** rotates, doing nothing during the time the hours strike. But then it meets the quarter-rack driving-pin **k**, and moves the quarter-rack back, tripping the quarter-pallets and causing both the large-hammer and the small-hammer to rise and drop, so striking the quarters.

The quarter-rack teeth **L** and **N**, are cut so that one set of teeth lifts and releases its hammer a fraction of a second after the other hammer, producing the double strike for the quarters.

The two quarter striking pallets and the hour striking pallet are loose on their arbors. The pallets are *moved by* the quarter-rack and hour-rack teeth and they move the hammers by pins acting on arms of the pallets.



Figure 6



Figure 7

Counting the hours and quarters

The hour and quarter racks simply strike the hammers an arbitrary number of times and we need a mechanism to control the number of strikes.

The *quarter-snail*, Figure 8 **S**, is rigidly fixed to the canon pinion and rotates once per hour. It has 4 steps corresponding to the 4 quarters. Provided the minute hand is correctly aligned with the quarter-snail, the quarter-snail will indicate the quarter on the dial in which the minute hand lies.

The *hour-snail*, Figure 8 **F**, is mounted beside the quarter-snail and underneath the *star-wheel* **H**, to which it is rigidly attached. Both are free to rotate, but the star-wheel and the *star wheel jumper* **b** hold the hour-snail in one of 12 positions. The hour-snail has 12 steps corresponding to the 12 hours and the star-wheel has 12 *rays*.

Each time the quarter-snail revolves, a piece mounted on it, the *hour-snail driver*, moves the star-wheel anti-clockwise one ray, or one twelfth of a rotation. So the hour-snail also rotates one twelfth to the next step on it, for the next hour.

The Continental Quarter Repeater

(Actually the process is more complicated as we will see later, but the effect is the same.) Provided the hour-snail and hour hand are correctly aligned, the hour-snail will indicate the hour on the dial in which the hour hand lies.

Note that the *only connection* between the going-train of the watch and the repeater mechanism is the quarter-snail fixed on the canon pinion; except for this the going-train and the repeater mechanism are completely independent.

The *winding-rack hour-snail arm*, Figure 8 **C-a**, limits how far the winding-rack can move when the push-piece is depressed, by contacting a step on the hour-snail **F**. As a result, it also limits how far the chain moves and how far the repeater-spring arbor and the attached hour-rack rotate. If the arm contacts the lowest (twelve hour) step on the snail, the chain and the arbor move further than if it contacts the highest (one hour) step. If the arm contacts the highest step on the snail, the hour-rack rotates so that the blank part and only one tooth move past the hour-pallet. If the arm contacts the lowest (twelve hour) step, the hour-rack rotates so that the blank part and all twelve teeth pass the hour-pallet. On releasing the push-piece, between one and twelve hours will strike, depending on the position of the hour-snail.

Clearly the length of the chain **e** and the depths of the hour-snail steps control how far the hour-rack rotates and they must be exactly right; if not, too few or too many teeth will go past the hour-pallet and the wrong hour will strike.

Likewise the *quarter-rack quarter-snail arm*, Figure 8 **c**, limits how far the quarter-rack can move. When the push-piece is depressed, the quarter-rack drops because of the pressure of its spring **f**. How far it drops, and hence how many of its teeth pass the quarter-pallets, depends on the step of the quarter-snail that this arm meets. No teeth will pass with the highest step and all three teeth will pass with the lowest step. After the hours have been struck by the hour-rack, the quarter-rack gathering-pallet continues to rotate with the repeater-spring arbor and, after a little time, it reaches the quarter-rack driving-pin **k**. It then forces the rack to return, tripping the quarter-pallets the correct number of times for the quarter. Of course, the depths of the quarter-snail steps must be just right to ensure that the correct number of teeth pass the pallets.

Operating the hammers

First, consider the small-hammer **P**, Figure 9, and its quarter-pallet **O**, Figure 10. This hammer is only used to strike the quarters.

The small-hammer **P** has a pin **y**, the *small-hammer quarter-pallet lifting pin*, between its arbor **U** and its head, and this pin protrudes through a slot in the pillar plate. The pallet **O** sits loose on the hammer arbor **U**, which also extends above the plate, and this pallet has two arms, one meshing with the quarter-rack teeth **N** and the other on the outside of pin **y**.

When the push-piece is depressed, the quarter-rack rotates anti-clockwise around its pivot **M** and its teeth slip past the loose pallet. During striking the quarter-rack rotates clockwise and each tooth moves the pallet anti-clockwise until it suddenly escapes. At the same time the other arm of the pallet moves the small-hammer quarter-pallet lifting-pin **y**, lifting the hammer anti-clockwise and tensioning the *small-hammer strike-spring* **b**. When the pallet escapes the hammer drops and strikes the gong or bell.

The *small-hammer counter-spring* **i**, which can be adjusted by the screw on the outside near IX on the dial, controls the hammer's movement so that it hits the bell or gong and then rebounds to produce a single, clear sound.

Note that the quarter-pallet **O** must be able to move out of the way when the quarter-rack drops and rotates anti-clockwise. But if it stayed in that position it would not be moved by the teeth when the quarter-rack returns and there would be no striking. To ensure the small-hammer quarter-pallet will normally stay in mesh with the teeth, the *quarter-pallet return spring* **g**, holds the pallet in the correct position.



Figure 8

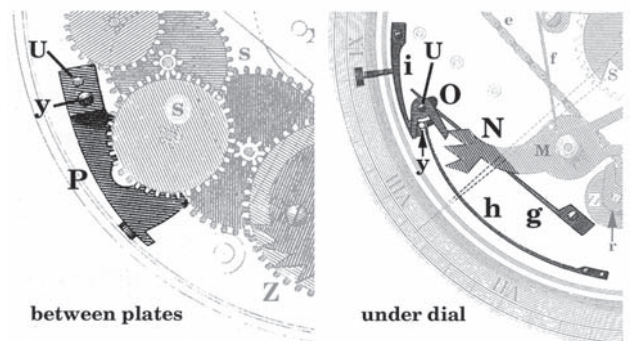

Figure 9

Figure 10

The Continental Quarter Repeater

The large-hammer, Figure 11 **R**, strikes both the quarters and the hours and has two separate pallets, one for quarter striking and one for hour striking. (Note that Figure 11 shows the hammer lifted up by the pallet and ready for striking. The shape of the large hammer is dictated by the positions of the going-train wheels. In Figure 11, a verge watch, **T** is the third wheel pivot, **V** the contrate wheel pivot, **W** the escape wheel, **X** the potence, and **x** the counter-potence.) As well as the hammer arbor **6**, there are three pins, **1**, **2** and **3**, which protrude above the plate. Pins **1** and **3** are visible in Figures 12, 34 and 35 (page 19), but pin **2** is hidden under the spring **q**, which presses against pin **3**. Pins **1** and **2** are attached to the large-hammer and pin **3** is attached to the hour-pallet. Figure 13 gives a good view of the hammer, the pallets and these three pins.

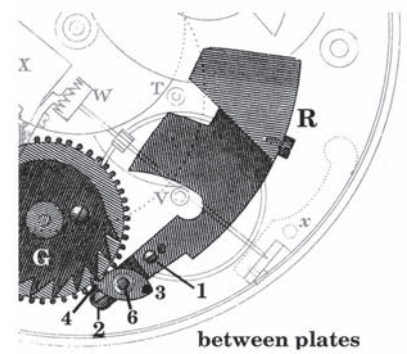

Figure 11

Quarter striking is the same as for the small-hammer, except that separate pins are used for lifting the hammer and for striking. The *quarter-pallet for the large-hammer*, Figure 13 **Q-5**, sits loose on the hammer arbor above the plate. Only arm **Q** is visible in Figure 12 because the spring **q** passes over arm **5**, which is why this pallet is on two levels as shown in Figure 13. Both arms are visible in Figure 36 because that repeater uses a different arrangement for the springs.



Figure 12

The *large-hammer quarter-pallet lifting-pin 2* (hidden under the spring **q**) is on the outside of the arm **5** of the quarter-pallet and lifts the hammer. The *large-hammer strike-pin 1* only serves the function of striking for both hours and quarters, and it sits between the *large-hammer strike-spring p* and the *large-hammer counter-spring o*.

When the push-piece is depressed, the quarter-rack rotates anti-clockwise around its pivot **M** and its teeth **L** slip past the loose pallet's arm **Q**. During striking the quarter-rack rotates clockwise and each tooth moves the pallet arm **Q** anti-clockwise until it suddenly escapes. At the same time arm **5** of the pallet moves the large-hammer quarter-pallet lifting-pin **2**, lifting the hammer (anti-clockwise) and tensioning the large-hammer strike-spring **p**. When the pallet escapes the hammer drops and strikes the gong or bell.

In Figure 12 there appears to be no quarter-pallet return spring for the large-hammer, corresponding to **g** for the small-hammer, but it must exist for the same reason, to keep the pallet in mesh with the teeth **L**. However, in this watch the spring **q** performs two functions. It is slit so that two separate leaves came from a single head, one acting as the quarter-pallet return spring and the other acting as the hour-pallet return spring. In contrast, the movement shown in Figure 36 has a separate *large-hammer quarter-pallet return spring 9*.

Hour striking is basically the same as quarter striking. The *hour-pallet*, Figures 11 and 13 **3-4**, is also loose on the hammer arbor and meshes with the hour-rack. Because the pallet sits above the hammer, between the plates, the *hour-pallet large-hammer lifting pin*, pin **3** on the pallet, extends below the pallet. This extension lifts the hammer when the pallet is moved by the hour-rack. Figure 37 has an alternative arrangement where the pallet is under the hammer; remember that this illustration is an underneath view.

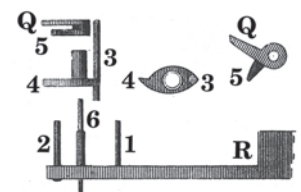

Figure 13

As with the quarter pallets, it is necessary that the hour-pallet can move clockwise out of mesh with the hour-rack when the repeater is wound by depressing the push piece, but it must return into mesh for striking. In Figures 12, 34 and 35, the double function spring **q** acts as the *hour-pallet return spring*. It presses lightly on pin **3** to ensure the pallet returns after having been pushed aside by the hour-rack during winding. The repeater in Figure 36 uses two separate return springs. Spring **9** is the quarter-pallet return spring. The hour-pallet return spring is not shown, but it is inside the movement frame and acts on the *hour-pallet return arm*, Figure 37 **16**.

As noted above, all three of the pins, **1**, **2** and **3**, protrude above the plate. Pin **2** meshes with the quarter-pallet, pin **1** is held between the strike and counter-springs, and pin **3** is used by the return spring.

However, pin **3** protrudes through the plate in Figure 36, even though it is not used for a return spring!

Let me repeat: every part has a *precise shape, size, position and function*, and every part is *essential* to the correct behaviour of the mechanism. That is, if pin **3** protrudes through the plate then there *must* be a reason even if we do not know what it is. Indeed, pin **3** has another, very important function which will be explained shortly.

The Continental Quarter Repeater

Simple but useless!

If that were all, quarter repeaters would be quite simple. However, such a mechanism has a number of defects which can cause it to strike the wrong number of times or even come to a halt. There are five distinct problems:

1. If the push-piece is depressed a little and released, then the wrong number of quarters can be struck.
As soon as the push piece is pressed, the quarter-rack gathering-pallet *r* (Figure 8) moves away from the quarter-rack driving pin *k*, the quarter-rack drops, and some teeth can move past the quarter pallets (up to the number allowed by the quarter-snail). When pressure is released these quarters strike. If the push piece is only depressed a small amount, so that the quarter-rack quarter-snail arm does not reach the quarter-snail, then no hours and too few quarters will strike. There will be no hours because if the hour-rack rotates far enough to strike even one hour, then the quarter-rack gathering-pallet must have rotated far enough to allow the quarter-rack to drop onto the quarter-snail and strike the correct number of quarters.
So, there must be a mechanism to prevent quarter striking unless the quarter-rack drops onto the quarter-snail.
2. If the push-piece is depressed further, but not far enough, and then released, the wrong number of hours will be struck.
Hour counting depends on the hour-rack rotating as far as it can, according to the position of the hour-snail. If it does not rotate far enough, too few hours will be struck unless there is some mechanism to prevent this happening.

Problems 1 and 2 must be considered together. What is needed is some way to prevent *all* striking when the push piece is not depressed far enough. That is, there should be no striking at all until both the winding rack arm *C-a* and the quarter-rack arm *c* have reached the hour-snail and quarter-snail respectively. In fact, because the quarter-rack arm *c* reaches the quarter-snail before the winding-rack arm *C-a* reaches the hour-snail, we can simplify this to just requiring the winding-rack arm reaching the hour-snail.

3. The quarter-snail, Figure 14 *S*, is rigidly attached to the canon pinion and is continuously rotating clockwise with the motion-work. If the repeater is activated a few seconds before an hour, the quarter-rack quarter-snail arm *c* will fall into the three-quarter step. But because it takes some time to strike the hours and quarters, the quarter-snail arm *c* will block the quarter-snail and prevent it and the canon pinion rotating. In which case, either the canon pinion will slip, causing the hands to stop moving, or the watch will stop completely.

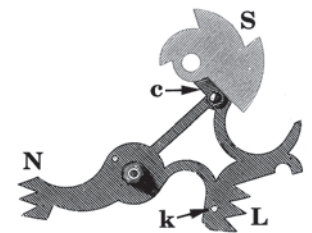

Figure 14

Even worse, the repeater mechanism could jam. The strength of the repeater-spring must be greater than the combined forces opposing it. During quarter striking these forces are the strengths of the quarter-rack drop spring and the hammer strike springs, the friction of the repeater train and its delay, and the energy needed to raise up the winding rack and push piece against gravity when the watch is vertical. The additional friction caused by the quarter-snail pressing against the quarter-rack snail arm may be enough to exceed the available power, in which case the repeater mechanism will stop with the racks dropped onto the snails, and the going train will be jammed for ever, or until the canon pinion is turned backwards to release the repeater mechanism. This situation would be disastrous. (Actually, the worst case is if the repeater is activated and the watch held pendant down by the pendant; then the repeater-spring must lift up the whole watch against gravity.)

4. Similarly, if we activate the repeater just before I, the winding-rack hour-snail arm *C-a* will fall into the deepest step of the snail for XII, as in Figure 15. But at the same time the hour-snail is being rotated anti-clockwise by the hour-snail driver attached to the quarter-snail, and the arm *C-a* will be pressed against the side of the step for I. Then the quarter-snail, unable to move the hour-snail, will be stopped, causing the hands to stop moving or the watch to stop completely, depending on how tight the canon pinion is on the center arbor. Note that in this case both the hour-snail and quarter-snail are prevented from moving by their respective snail arms.

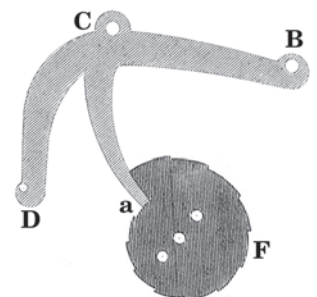

Figure 15

5. Any machine has to have some play in its moving parts and this freedom increases over time with wear. Assume the hands are at 10h 59m 59s, just before the hour on the dial, and the repeater is activated. Will the winding-rack arm *C-a* fall on the X step of the hour-snail or the XI step? That is, if the arm is very near to the edge of an hour-snail step, will it sit on the step or will the play allow it to drop onto to the next step? This is a matter of accuracy, but it is very important, because 11:45 could sound at 10:59 if the wrong step of the snail is used.

The Continental Quarter Repeater

The same problem of play and inaccuracy occurs with the quarter-snail. That is, the quarter-rack could drop onto the three-quarter step at the hour and three quarters could strike instead of none. And the reverse is possible; the quarter-rack could drop onto the zero-quarter step just before the hour and no quarters could strike instead of three.

The repeater mechanism, as I have described it, is quite useless, and each of these problems requires adding some clever and subtle complications.

The *all-or-nothing piece* solves problem 1 by holding the quarter-rack away from the snail unless the push-piece is depressed as far as it will go.

The *quarter-rack* and the *hour-pallet large-hammer lifting pin* solve problem 2 by preventing the hours from being struck unless the push-piece is depressed as far as it will go.

The *surprise-piece* resolves problem 3 by preventing the quarter-rack arm *c* from jamming against the quarter-snail.

The *star wheel and its jumper* solve problem 4 by ensuring that arm *a* of the winding-rack cannot jam against the hour-snail.

And finally, the star-wheel and jumper, and the surprise piece, resolve any problems with play.

The all-or-nothing piece

To solve the first problem, the quarter-rack is locked so that it cannot drop unless the push piece is depressed far enough. When the gathering-pallet moves away from the quarter-rack driving pin, the quarter-rack will not move until the position of the push piece allows it to drop. The quarter-rack could be unlocked as soon as the gathering pallet has moved far enough to allow quarter-rack to drop onto the quarter-snail, when the correct quarter will be struck. But because the winding-rack arm *C-a* does not reach the hour-snail until after this, the hour striking can be wrong. So the quarter-rack should only be unlocked when the winding-rack hour-snail arm *C-a* reaches the hour-snail to ensure both the hours and the quarters strike correctly.

The quarter-rack is always trying to rotate anti-clockwise and drop onto the quarter-snail because of the pressure of its drop spring, Figures 6 and 7 *f*. The *all-or-nothing piece*, Figure 16 *I-j-K*, acts as a detent at *K*, locking the quarter-rack so that it cannot drop. So that the quarter-rack can drop when required, the all-or-nothing piece pivots at *I* and can rotate anti-clockwise to release the detent.

The *all-or-nothing piece return-spring J* is kept in tension by a stud at *w*, which is attached to the plate and passes through a hole in the all-or-nothing piece. The pressure of this spring tries to push the stud outwards, but it is fixed. So to relieve the tension, it presses the all-or-nothing piece towards the center and maintains the lock on the quarter-rack. By doing so it prevents quarter-rack dropping unless the all-or-nothing piece is pushed outward, against the pressure of the spring, releasing the quarter-rack. (It may be easier to visualise this if you replace the plate by an arm, so that there are two arms hinged together at *I*. Then the spring mounted on one arm, the all-or-nothing piece, presses against the other arm, the plate, forcing them apart. This is the same as mounting the spring on the other arm, the plate, and having it press on the all-or-nothing piece.)

As noted above, the only way we can tell if the push-piece has been depressed properly is if arm *C-a* touches the hour-snail. If it does not, the push-piece has not moved far enough, as in problem 2, and the quarter-rack should not be released.

The method for unlocking the quarter-rack is crude but ingenious. The all-or-nothing piece supports the top pivot of the star-wheel and hour-snail at *j*. The corresponding hole in the plate for the bottom pivot is elongated and has sufficient play for the star-wheel and hour-snail to move a little *sideways*. This play is just enough for the all-or-nothing piece to turn on its pivot *I* and so move the detent *K* away from the locking-face of the quarter-rack, allowing it to drop. Of course, the movement must be very small, to avoid breaking or bending the star-wheel pivots, and the *all-or-nothing piece spring-stud* at *w*, for the return-spring *J*, sits inside a small hole in the all-or-nothing piece and acts as a banking pin.



Figure 16

The Continental Quarter Repeater

A better arrangement is to attach the star-wheel and hour-snail to the all-or-nothing piece by a shoulder screw. This is done in the repeater we are looking at, the screw can be seen at **j** in Figure 16, and in the repeater in Figure 36 (page 19). However, the all-or-nothing piece is then dangling from its pivot **I** and must be supported or it will sag. So there has to be at least a small shoulder under it.

Thus, the quarter-rack can only be unlocked if the winding-rack hour-snail arm **C-a** pushes hard enough against the hour-snail to move the snail, star-wheel and all-or-nothing piece sideways. Which is just what we want, because this can only happen if the winding-rack is pressed down far enough to produce correct striking.

As we have already seen, when striking takes place the quarter-rack is rotated clockwise, against the pressure of spring **f**, by the quarter-rack gathering-pallet **r**. At the same time the chain pulls the winding-rack arm **C-a** away from the hour-snail, allowing the star wheel pivot **j** and the all-or-nothing piece to return to their original position under the pressure of the return spring **J**. Eventually the gathering-pallet will move the quarter-rack back to its original position, it will push past the all-or-nothing piece and once again it will be locked by the detent at **K**.

The hour-pallet large-hammer lifting pin

Problem 2 is a separate issue. Even though the all-or-nothing piece will prevent incorrect quarter striking, the incorrect number of hours will be struck when the push-piece is not depressed far enough. The hour-rack will rotate, but not enough of its teeth will pass the hour-pallet, and on its return the hour-pallet will lift and drop the large hammer too few times. (Because the all-or-nothing piece is not unlocked, no quarters will strike.) To overcome this we need a mechanism which will allow the push-piece, chain, repeater-spring and hour-rack to return to rest without any striking. This can only be done if the hour-pallet is held away from the hour-rack, for then the repeater-train can unwind silently.

Having solved problem 1 there are two pieces whose positions indicate that the push-piece has been depressed far enough; the arm **C-a** touching the hour-snail and the quarter-rack dropping. One of these must somehow control the position of the hour-pallet.

Hour striking is prevented by pin **3** of the hour-pallet; see Figure 16. When the quarter-rack is locked, the *quarter-rack locking-face m*, holds the *hour-pallet large-hammer lifting pin 3* so that the hour-pallet is rotated clockwise and swung out of mesh with the hour-rack. When the quarter-rack drops, the hour-pallet large-hammer lifting pin is released and the *hour-pallet return spring q* pushes the pallet into mesh with the hour-rack.

So when the repeater is at rest, the all-or-nothing piece locks the quarter-rack which, in turn, keeps the hour-pallet out of mesh. Any inadequate pressure on the push-piece will wind the repeater-spring which will then run down without any striking at all.

If we unlock the all-or-nothing piece detent, the quarter-rack drops and the hour-pallet is freed, which can only happen if the push-piece is fully depressed. Then the repeater will strike the correct hours and quarters. But as soon as it finishes striking, the quarter-rack gathering-pallet will raise the quarter-rack so that it is again locked by the all-or-nothing piece and the hour-pallet is again made inoperative by the quarter-rack locking-face **m**.

Thus pin **3** performs two or three functions. First, its basic role is to lift the large-hammer for striking, which is why it is called the hour-pallet large-hammer lifting pin. Second, in conjunction with the quarter-rack locking face, it keeps the hour-pallet out of mesh with the hour-rack until the quarter rack drops to allow striking. And third, in some repeaters it is used by the hour-pallet return spring to keep the hour-pallet in mesh with the hour-rack during striking.

The all-or-nothing piece gets its name from the fact that it ensures correct striking or no striking at all, directly controlling quarter striking and indirectly controlling hour striking.

At this point we know enough to understand a side issue, how the repeater spring is set up. As noted when discussing Figures 2 and 3, the repeater spring has 3 or 4 turns. In order for striking to be rapid and loud, the spring has to be set up so that one of the middle turns is used; otherwise it will lose power before striking has been completed. Now, the barrel arbor can rotate until the quarter-rack gathering-pallet **r** has returned the quarter-rack to its at-rest position, when it is pressed against the pallet **q** (as in Figures 1, 16 and 34), at which point it can rotate no further. So the repeater spring can be set up by rotating the barrel arbor to tension the spring before putting the gathering-pallet **r** on the square on the barrel arbor.

The star-wheel and jumper

Now things get difficult! But to make it easier we will consider the fourth problem before the third.

The fourth problem, of the winding-rack hour-snail arm **C-a** jamming, is the reason for having the star-wheel. At the same time the star-wheel overcomes part of the fifth problem, ensuring play or inaccuracy will not cause the hour-snail arm to drop onto the wrong step.

The Continental Quarter Repeater

The hour-snail, unlike the hour hand, is not geared to the canon pinion and is perfectly free to rotate. The star-wheel **H** and its jumper **b**, Figure 17, are used to hold the hour-snail in position so that it presents the correct hour step to the winding-rack. The jumper-spring **d** is weak and the star-wheel and snail will rotate very easily, but if they are moved only a small amount the jumper will return them to their current, correct position.



Figure 17

This is the situation at all times except when the hour is changed. As mentioned above, the hour is changed by the *hour-snail driver*, a piece mounted on the quarter-snail which turns the star-wheel. (As I have noted, the true situation, explained below, is more complicated, but the effect is the same.) When the hour-snail driver rotates the star-wheel, the jumper rises up a ray until it reaches the point, and then it suddenly drops down the other side pulling the star-wheel and hour-snail around quickly so that the hour-snail is correctly positioned for the next hour.

To understand the behaviour of the snails we need to use angles. In one hour the minute hand rotates through 360° , and so the minute hand rotates through 6° in one minute. The hour hand rotates through 360° in 12 hours, and so it moves 30° in one hour.

Consequently, each step of the hour-snail and the rays of the star wheel cover 30° . As there are 12 rays and the hour-snail driver on the quarter-snail acts only to move a ray half its width, the canon pinion and the minute hand move 15° , which is one twenty-fourth of an hour or $2\frac{1}{2}$ minutes, to change the hour. That is, when the minute hand is at $57\frac{1}{2}$ minutes the star-wheel and hour-snail start moving, and when the minute hand is at 60 they rapidly jump to the next hour.

The hour-snail driver on the quarter-snail and the star-wheel act a bit like two meshing gears, and the distance moved depends on the ratio of the diameters at the point of contact, their pitch circles. However, the shape of the star-wheel “teeth” mean that this is very crude analogy. For example, if the hour-snail driver meets the tip of a ray then the hour-snail will only be advanced a short distance before the tip is free of the driver, irrespective of the pitch circles.

In order to understand what happens, it is necessary to be very precise. As shown in Figures 18 and 20, the hour-snail is positioned so that the *trailing edge* of arm **C-a** of the winding-rack (the edge closest to the previous hour step) normally meets the snail close to the *leading end* of a step (that nearest the previous hour step); there should be a small gap to ensure it cannot meet the end of the step for the previous hour. (Confusing! The snail rotates anti-clockwise and the leading end of a step is the end first met by **C-a**. Instead, if you imagine the snail is fixed and **C-a** rotates clockwise around it, then the leading edge of **C-a** is the edge that first meets the next step of the snail.)

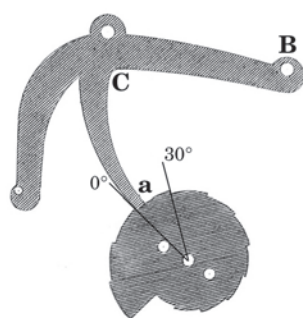

Normal position for hour IV

Figure 18

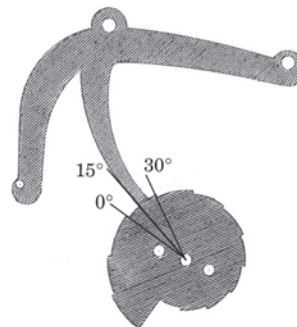

Position for hour IV when jumper is at point of ray

Figure 19

When the jumper reaches the point of the next ray the hour-snail has rotated 15° and the trailing edge of the arm meets the step in the middle. This means that during the $2\frac{1}{2}$ minutes the correct hour step is presented to the arm **C-a**. Then, when the star-wheel jumps the hour-snail is moved into exactly the same position as in Figures 18 and 20, but for the *next* hour. And so, when the minute-hand is on or after 60 the correct step of the hour-snail is presented to the arm **C-a**.

The Continental Quarter Repeater

It is only during the very brief moment when the jumper pulls the snail the rest of the way that the arm can fall on either step. Consequently, except at the instant when the hour-snail jumps, which should happen when the minute hand is exactly on XII (60 minutes), the correct hour must be registered. So a small inaccuracy or some play cannot cause wrong striking.

The correct position for the star-wheel is with the tip of a ray on the line of centers between the quarter-snail and the star-wheel. It should also be noted that the position of the hour-snail relative to arm **C-a** can be adjusted by moving the jumper slightly. So, provided the snail is cut accurately, it is easy to ensure the correct step will always be used.

In addition to angles, we need to be clear about widths. On a tower clock with a 10 feet (3 metre) dial, the tip of the minute hand moves a distance of about 6 inches (150 mm) in one minute or 6° . But the minute hand of a pocket watch with a 2 inch (50 mm) dial only moves about $\frac{1}{10}$ inch (2.5 mm) in a minute, the same 6° . In both cases the length of the arc is actually $2\pi r(x/360)$, where r is the radius of the dial and x is the number of degrees.

So if a snail rotates 15° then the *distance* moved depends on the step and its radius, and the outermost I hour step is wider than the inner XII hour step. Consequently, the amount of a step covered by the snail arm **C-a** depends on the fixed width of the arm and the variable width of the step.

The width of arm **C-a** must be *at most* half that of the narrowest, XII step; in Figures 20 and 21 it is a little narrower. If it is wider, then when the jumper is at the point of the next ray and the snail has advanced 15° , the leading edge will hit the I step and not drop into the XII step.

Now we can look at the 1 o'clock problem, Figure 21. But first, note that arm **C-a** is only in contact with the hour-snail while the push-piece is being pressed. As soon as the push-piece is released, the repeater-train runs and arm **C-a** is drawn away from the snail. Because the hour-snail is completely detached from the going-train, except just before the hour, continued pressure on the push-piece will have no effect on anything. (Just before the hour, when the hour-snail driver is moving the star-wheel, continued pressure for several seconds may prevent the quarter-snail turning and so prevent the canon pinion turning; which will either cause the canon pinion to slip or the watch to stop. It is impossible to design a machine that is totally protected from human stupidity!)

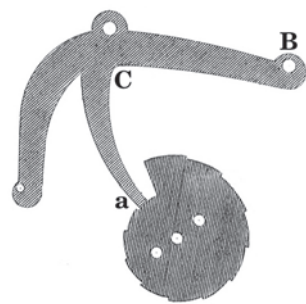

Normal position for hour XII

Figure 20

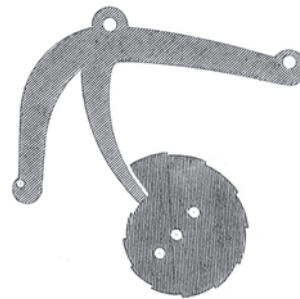

Position for hour XII when jumper is at point of ray

Figure 21

Now, at every hour change, except from XII to I, the next step on the hour-snail is deeper. Consequently as arm **C-a** rises away from the snail they cannot touch each other and the width of the arm is irrelevant. However, just before 1 o'clock, arm **C-a** will enter the deepest step, that for XII and, because the snail has moved forward 15° , the side of the step can press against the arm as the arm rises and the hour-snail rotates towards I, as shown in Figure 15 (page 7).

Let us assume it takes about a second, an excessively long time, to strike the hour once. One strike occurs when **C-a** is outside the hour-snail, because the outermost hour-snail step allows one hour to strike, so it will take about 11 seconds for **a** to rise from the bottom of the XII step, and in this time the canon pinion will rotate a little more than 1° (1 minute occupies 6° and so 10 seconds, one sixth of a minute, occupies 1°). There are two cases:

1. Before 59m 49s the arm C-a falls on the hour-snail far enough away from the side of the I step that it will rise up without interfering with the snail.
2. Between 59m 50s and 59m 59s the arm will fall closer to the I step and the snail will, at some time, press against the arm. During this time the star-wheel is being pushed by the quarter-snail and the jumper is rising up the side of a ray. When it reaches the tip, the snail will have rotated so that the edge of the step is against the arm. From that moment onwards, until the arm clears the hour-snail, the star-wheel cannot move away from the hour-snail driver on the quarter-snail, and the hour-snail continues to be pushed but it cannot move.

However, if we arrange for a gap a little greater than 1° between **C-a** and the side of the step at the latest time of 59m 59s, as in Figure 21, then the star-wheel will jump forward when the jumper reaches the point of the ray, pressing the hour-snail against the arm. But there will now be a gap between the hour-snail driver on the

The Continental Quarter Repeater

quarter-snail and the star-wheel ray that it was pushing. So the canon pinion can continue to rotate without interference. And the arm will rise up without difficulty because the hour-snail is held against it only by the weak star-wheel jumper-spring.

The necessary *freedom* can be achieved in two ways. First, the XII step can be made, say, $1\frac{1}{2}^\circ$ wider and the I step narrower. Because of the way the star-wheel moves the snail, this has no effect on striking at any other time. And second, as mentioned above, the maximum width of arm **C-a** is half the XII step or 15° . If it is reduced to 13° by cutting back the leading edge, the necessary gap between **a** and the side of step XII is achieved, allowing **a** to rise with the snail resting on it very lightly.

Understanding how repeaters work takes considerable effort. Although watching a repeater in operation is very helpful, not everything can be seen. And, anyway, we see what it *does* without necessarily knowing *why*. It is essential that the action and interaction of every part is visualised and we continually question the reasons for what we see in our minds.

To illustrate this point, look at Figure 22.

Lecoultrre, in *A Guide to Complicated Watches*, gives a detailed description of how to make an hour-snail, illustrating the discussion with Figure 22. This shows an hour-snail with step I half its normal width and step XII $1\frac{1}{2}$ times its normal width. But as we have seen, reducing one step to 15° and increasing the other to 45° , giving 15° of freedom, is unnecessary and makes no sense. So why has he done this?

The first stage in understanding is to visualise how this snail would work in the context of what we know from Figures 18, 19, 20 and 21, with the snail arm at most 15° wide. On and after 1 o'clock, when the star-wheel jumper has moved the snail to the I step, and the repeater is activated, the snail arm will drop into the 15° extension of the XII step and 12 hours will sound throughout 1 o'clock! Then, just before II, as the star-wheel moves the snail for the next hour, the arm will fall onto what is left of the I step and 1 hour will sound! It appears that Lecoultrre's drawing is totally wrong and we are tempted to question whether he understands anything at all about repeaters.

But can Lecoultrre's hour-snail work? Well yes, if we change things a bit by rotating the hour-snail 15° relative to the star-wheel.

But first, when a repeater is made the hour-snail and star-wheel must be very carefully aligned before they are screwed together. The normal alignment, which I have been describing, is as illustrated in Figures 18 and 20. Now, if we rotate the hour-snail anti-clockwise before fixing it to the star-wheel, then the snail arm **C-a** will land on the steps further from their leading ends. And when the jumper is at the point of a ray, the leading edge of **C-a** will move closer to the end of the step. If we move the star wheel 13° , the arm will drop 13° and 28° from the leading end of the step, as in Figures 23 and 24.

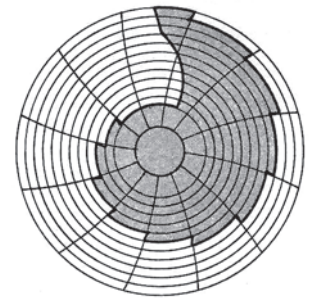
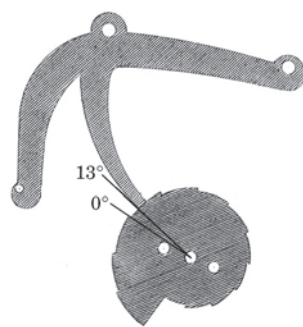
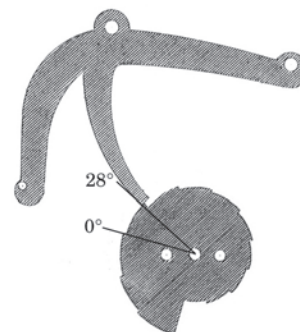

Figure 22



Normal position for hour IV

Figure 23



Position for hour IV when jumper is at point of ray

Figure 24

If the snail is rotated 15° then the arm will incorrectly drop into the V step just *before* V. Or it could sit on the very end of the IV step, and pressure on the winding rack could damage the snail and/or the snail arm.

But in the case of the deepest XII step, if we rotate the snail even a few degrees then, with the jumper at the top of a ray, the arm will wrongly fall onto the I step instead of into the XII step. If the snail is rotated 15° then the arm will drop fully onto the I step. Unless, of course, we cut back the I step by the same amount that we have rotated the snail. Which is what Lecoultrre is apparently suggesting, as in Figures 25 and 26.

Then when the jumper is at the point of the ray just before I, the snail arm will drop into the extended XII hour step. But as soon as the star-wheel jumps the arm will fall on the remaining half of the I step.

But then the arm is likely to fall onto the wrong step at all other hour changes!

The Continental Quarter Repeater

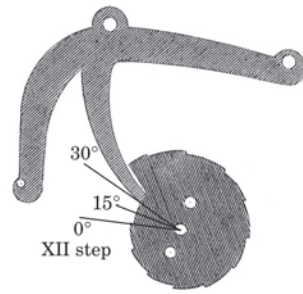

Position for hour XII when jumper is at point of ray

Figure 25

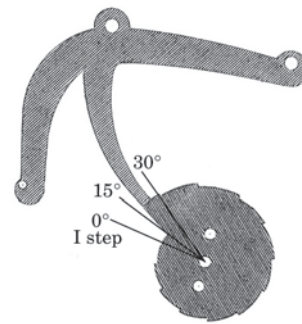

Normal position for hour I

Figure 26

All is not lost. The width of the snail arm has been dictated by the width of the XII step, which is now much wider. So the snail arm can be made much wider than 15° , on the *trailing edge side*, to overcome this problem. Indeed, it can be made nearly the full 30° wide to ensure it acts safely on all steps at all times.

So Lecoultré's hour-snail can work, but why bother? Well, even if it doesn't seem a good idea, at least it improves our understanding of how the star-wheel works.

The surprise-piece

The third problem, that of the quarter-rack quarter-snail arm *c* jamming, is solved by the *surprise-piece*. In his book, Crespe's student asks "Please give me a description of the surprise-piece, which few horologists can explain?" It seems that nothing has changed in the last two hundred years and few, if any, twentieth century horologists can explain it. Perhaps this is because of the misleading name that it has been given. The term "surprise-piece" comes from the surprising way it appears from under the quarter-snail rather than its function, which is odd as all other pieces are named for what they do. It should be called the *quarter-snail freedom piece*, and I will use that term later.

Before examining the surprise piece, I will consider the related fifth problem above.

Unlike the hour-snail, the quarter-snail is rigidly fixed to the canon pinion and is continuously driven by the going-train. Consequently, the quarter-rack arm *c* can drop precariously onto the very edge of a step; Figure 27 is the position at 29m 59s. If this happened with the winding-rack arm *C-a* and the hour-snail it could be disastrous, because *a* is pressed against the snail with considerable force and the edge of the step or arm *a* could be damaged; but this cannot happen because of the star-wheel, as we have seen. However, arm *c* drops lightly onto the quarter-snail under the pressure of the weak quarter-snail drop-spring *f* and damage is unlikely.

Except for just before and at the hour, as the quarter-snail is continuously turning clockwise, arm *c* will simply drop off the step into the next deeper one while the hours are striking and one more quarter will be struck; but as the minute hand has moved to the next quarter the striking will be correct. Alternatively, if *c* lands on the step a little further back it will simply stay on that step. The quarter-rack drop-spring *f* needs to be weak to minimise friction as the snail moves under *c*. Thus, other than just before the hour, a slight inaccuracy or play will not cause a recognisable error in striking and the fifth problem can be ignored.

Note that the important part of the snail arm *c* is the *trailing edge*, the edge nearest the previous quarter. The minute hand of the watch is aligned to this edge so that as the hand reaches 15, 30 and 45 minutes the snail arm drops into the next step of the snail. Also note that, because arm *c* moves in an arc, the edges of the snail steps are undercut to follow the movement of the arm.

The same situation must occur on the hour. At 59m 59s, Figure 28, the arm must drop into the $\frac{3}{4}$ step and its trailing edge must be on the 60 minute arc. For this to happen the three-quarter step *must* be widened and the hour-step narrowed by exactly the width of the snail arm. Then, at 60m, the *leading edge* of *c*, the one closest to the next quarter, will fall on the edge of the outermost, 60 minute step.

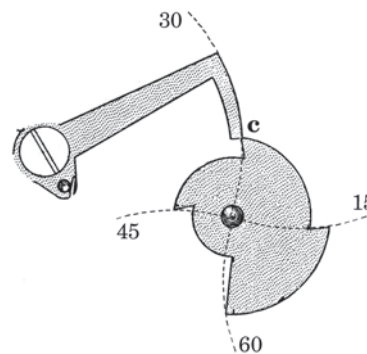

Figure 27

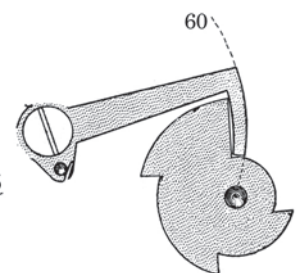

Figure 28

The Continental Quarter Repeater

(If a quarter-snail or hour-snail is cut regularly, as in Figure 27, a line from the edge of one step to the edge of the opposite step should pass through the center. Many books, including those by Berthoud and Hillmann, show quarter snails drawn with equal steps. These drawings are clearly wrong.)

However, just at the hour c might drop into the $\frac{3}{4}$ step and the hour-snail arm $C-a$ onto the step for the next hour. This could occur if the quarter-snail is not divided accurately or if there is some play, so that just as the jumper forces the star-wheel around, the $\frac{3}{4}$ step is still accessible; and consequently we may hear 2:45 at 2:00.

The reverse, striking 1:00 at 1:59 is also possible, when the arm drops onto the 60 minute or zero quarter step prematurely. This problem is easily resolved by slightly cutting back the hour step or by narrowing the snail arm c . In which case the repeater will work correctly or, more likely, we will end up with the first problem and c will drop into the $\frac{3}{4}$ step on the hour.

The most important point to be remembered by people who repair repeaters is *never alter any part unless the problem is completely and correctly understood*. Incorrect striking can be caused by many things. For example, a badly shaped star wheel or star wheel jumper, or excessive play of the quarter-rack on its stud M . Also note that the snail arm c in the repeater of Figures 34 and 35 is an extension screwed onto the quarter rack. This has probably been done to adjust for problems like those being discussed.

Even though these errors are important, they are relatively insignificant, because no matter what we do the quarter-rack will jam against the side of the hour step. Whether just before, on or just after the hour, there will always be a time when, as in Figure 28, the quarter-rack arm c will drop onto the $\frac{3}{4}$ step, the snail will continue to turn and c will jam up against the side of the hour step. This will cause the canon pinion to slip, the going-train to stop, or the entire repeater mechanism to jam. The problem is compounded by the fact that c rests on a step for a long time while the hours are struck. If there is a $\frac{3}{4}$ second gap between hour and quarter striking and each strike takes $\frac{3}{4}$ second, then up to 12 seconds must pass before c is completely withdrawn from the quarter-snail. And if c is right at the end of the $\frac{3}{4}$ step, the canon pinion will be locked for this time.

There is no simple solution to this, to have correct quarter striking while enabling the quarter-rack arm c to *rise freely without touching the quarter-snail*. To create a gap for freedom we must increase the width of the $\frac{3}{4}$ step and reduce the width of the hour step even further, or cut back the leading edge of the snail arm. But then c will drop into the $\frac{3}{4}$ step *after* the hour and incorrect striking will occur! And it will still jam because of the continuous rotation, but it will jam when it drops a little later after the hour.

The authors I have read do not appear to be aware of this problem and Crespe's student would be just as bemused now as in 1800. Lecoultre, in *A guide to complicated watches*, says the surprise-piece is to "facilitate the drop of the arm on the lowest step at the moment when the minute hand indicates 59m 50s. But the arm has no trouble *dropping*, and if it does it is easy to correct it; the problem is when it *rises up*". The translation of Hillmann in Seibel and Hagan's *Complicated watches* says "a guard piece is snapped into position to stop all quarter striking, or rather to eliminate any possibility of a quarter strike". Which is true on or after the hour, but it ignores the real problem which occurs just *before* the hour. A rough translation of Hillmann's *La Réparation des Montres Compliquées* reads "The goal of the surprise-piece is thus to make it possible to sound the three quarters immediately before the hour changes, and to remove any ringing of the quarters as soon as a new hour is prepared"; which is no better. Rees *The cyclopaedia or universal dictionary of arts, sciences, and literature* describes the surprise-piece but gives no explanation of its purpose. In Thomas Reid's *A treatise on clock and watch making, theoretical and practical*, the translation of Ferdinand Berthoud's 1763 *Essai sur l'horlogerie* says "the advance which the star-wheel teeth causes the surprise to make, serves to prevent the arm [of the quarter-rack] from falling into the step which would make the three quarters repeated when at the 60th minute". And Baillie in *Watches - their history, decoration and mechanism* says "It was found impractical to make the parts work together so accurately as to prevent this error".

All these explanations miss the point and none of them explain how the surprise-piece actually works and why it exists. They only refer to the problem of incorrect striking at the hour and not the need for freedom. We must *deliberately provide freedom* and so *deliberately* allow c to drop onto the $\frac{3}{4}$ step after the hour; the quarter-rack arm can only be free to rise if the $\frac{3}{4}$ step is made over wide and the hour step made too narrow. Thus incorrect striking at the hour is actually an *inevitable necessity* and we must have *a mechanism to extend the hour step* just on and after the hour so that incorrect striking cannot occur.

Crespe did not miss this point, although he too is vague. He says quite explicitly, when dividing the quarter-snail, "at mid-day the pointer will have to be past the point by about a minute [6°] in order to leave time for the surprise-piece to change the hour". As we will see, the surprise-piece does move the star-wheel to change the hour, but its *main* function has always been to compensate for the necessary freedom between arm c and the quarter-snail.

The quarter-snail must be cut unequally. The first and second quarter steps occupy 90° , but the third quarter is wider and the hour narrower. In Figure 28 the snail arm, when resting on the $\frac{3}{4}$ step, occupies about 15° or $2\frac{1}{2}$ minutes. So if

The Continental Quarter Repeater

we use Crespe's specification and allow 6° of freedom, the $\frac{3}{4}$ step must be made wider by 21° , the width of the arm plus 6° for freedom, and so it covers 111° , from 45 minutes to $3\frac{1}{2}$ minutes past the hour. And the hour step is correspondingly reduced by 21° to 69° , from $3\frac{1}{2}$ to 15 minutes. This large difference is a consequence of shifting the determination of time from the *trailing edge of the snail arm* at 45 minutes to the *leading edge* at 60 minutes. Such a snail provides the necessary freedom for 3 quarters to strike up to the hour without the quarter-rack arm jamming, provided striking takes less than 60 seconds. But without the surprise-piece, three quarters will strike up to 1 minute after the hour, and the arm will still jam.

(There is another explanation of Lecoultré's hour-snail in Figure 22: he made a ghastly mistake! Some five-minute repeaters sound the hour followed by the number of 5-minute intervals after the hour. They are exactly the same as quarter repeaters, but the 4-step quarter-snail is replaced by a 12-step 5-minute snail, and the quarter-rack by a 5-minute rack with two sets of 11 teeth. These watches use the same type of surprise piece and have a 5-minute snail exactly like that shown in Figure 22. Perhaps Lecoultré drew one of these snails by mistake?)

The *surprise-piece*, Figure 29 7, is mounted loose on the canon pinion **10** under the quarter-snail **S**. It is free to rotate but its movement is limited by pin **11** on the quarter-snail, which runs in a slot in the surprise-piece. As the canon pinion rotates (anti-clockwise in Figure 29 because we are looking at it from underneath) the quarter-snail draws the surprise-piece around with it. The *hour-snail driver* **8**, meshes with the star-wheel and rotates it in the way I described earlier (but without mentioning the surprise-piece). Thus the surprise-piece rotates with the quarter-snail, but being loose it can flop about and its movement is only limited by pin **11** and the slot.

The purpose of the surprise piece is to extend the hour step, so that on and just after the hour the snail arm cannot drop into the $\frac{3}{4}$ step, and so the full hour with no quarters sounds correctly. To do this, the slot and pin allow the surprise piece to move out so that it extends the hour step, ideally to the correct size of 90° . And the quarter-rack snail arm is made thick enough for it to land on either the snail or the surprise piece.

The surprise piece must not affect striking at any other time. Consequently, all of it, except the part used to extend the hour step, is smaller than the quarter-snail, and it will only affect how far the quarter-rack drops on or just after the hour.

Figure 29, from Hillmann *La Reparation des Montres Compliquées* is incorrect because the $\frac{3}{4}$ and hour steps are drawn the same width, 90° . Also, the section of the surprise piece near the hour-snail driver **8** must be the same diameter as the hour step for at least the distance that pin **11** and its slot allow it to move. It should not be smaller than the quarter snail until after this section.

Figure 30, from the same book, is also incorrect.

Because the surprise piece is loose, it will often be seen protruding from under the quarter-snail when its position is not being controlled by the hour-snail driver. So there is simply no justification for calling it a surprise piece, unless because people could not understand how something that apparently flopped about uncontrollably could be useful!

Figure 30 shows the position of the parts just before the hour. The canon pinion and quarter-snail **S** (shown in outline) are rotating clockwise, pin **11** is turning the surprise-piece, the hour-snail driver **8** on the surprise piece is turning the star-wheel and the hour-snail anti-clockwise, and the star-wheel jumper **b** has almost reached the tip of the next ray to change the hour. At this time the surprise-piece is held back under the hour step of the quarter-snail by the star-wheel jumper-spring acting on the ray being pushed and, if the quarter-rack drops, arm **c** will fall on the $\frac{3}{4}$ step. Until the jumper reaches the tip of the ray there is sufficient freedom for the quarter-rack to drop onto and rise up from the $\frac{3}{4}$ step.

Exactly at the hour the jumper reaches the point of the star-wheel ray and drops down the other side, pushing the star-wheel around anti-clockwise. The ray *behind* the hour-snail driver jumps forward and hits it, pushing the surprise-piece forward to fill in the $\frac{3}{4}$ step and form an extended hour step (as shown by the dotted lines marked with an asterisk); so the quarter-rack will fall on the enlarged hour step. At the same time, the ray *in front of* the hour-snail driver **8** has

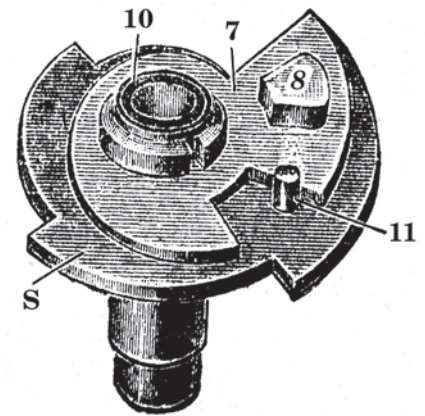

Figure 29

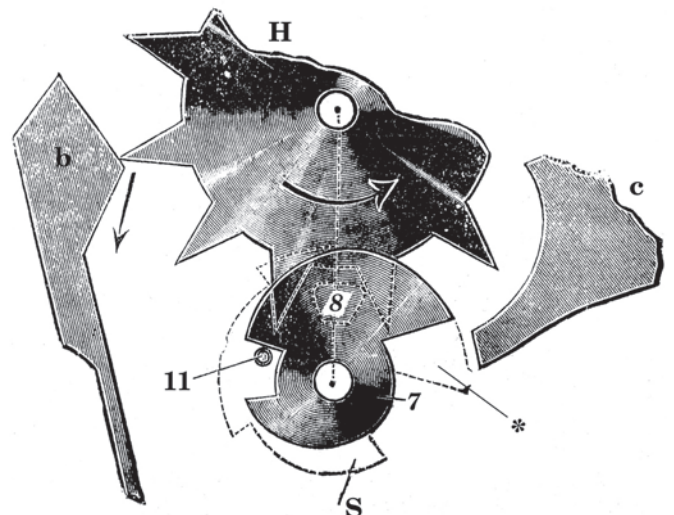

Figure 30

The Continental Quarter Repeater

jumped forward and pin **II** has moved to the other end of the surprise-piece slot. In this situation the quarter-snail and canon pinion are free to rotate until pin **II** catches up to the surprise-piece, and the surprise-piece is only held in position by the weak force of the star wheel jumper-spring acting on the ray.

Note that there are two complementary actions taking place. First, the hour-snail driver rotates the star-wheel against the pressure of the jumper spring. And second, using the pressure of the jumper spring, the star-wheel rotates the hour-snail driver. (The most common mechanism with complementary actions is the lever escapement. First the balance unlocks the escape wheel and then the escape wheel impulses the balance.)

Let us assume it takes an excessively long 30 seconds to strike 12 hours and 3 quarters. Then:

- At any time up to 12h 59m 30s the surprise-piece plays no part and 12:45 is struck normally, with sufficient freedom on the $\frac{3}{4}$ step for the quarter-rack to rise.
- At any time after 1h 00m 00s the surprise-piece ensures the quarter-rack falls on the extended hour step and, as the hour-snail has advanced, 1:00 is struck. To do this, the snail arm *c* is made thick enough to rest on both the snail and the surprise piece.
- Between 12h 59m 30s and 12h 59m 59s the surprise-piece is held back under the hour step and the quarter-rack drops onto the $\frac{3}{4}$ step while the hour-rack drops onto the 12 step. Again 12:45 will be struck correctly and the quarter-rack can rise without touching the quarter-snail because the $\frac{3}{4}$ step has been cut wide enough. But during striking the canon pinion will rotate to 1h 00m 00s, the star-wheel (and hour-snail) will jump forward and the surprise-piece will be pushed out to touch the quarter-rack arm. However, the surprise-piece is held only by the very light pressure of the star-wheel jumper-spring. As the quarter-snail rotates, the surprise-piece will be slowly pushed under the hour step, held very lightly between the quarter-rack arm and the star-wheel ray. And when the quarter-rack arm clears the snail the surprise piece will jump out again to extend the hour step.

Note that the hour-snail driver on the surprise piece must be a wide button (or two pins) and not just a single pin. If there was just a pin, then the ray of the star-wheel behind it would not be able to push the surprise piece out. Also the surprise piece should completely fill the hour step so that it fully supports the snail arm at 60 minutes; in my example this means that it must be able to move through about 21° .

On the hour, the advance of the hour-snail and star-wheel should be exactly 15° . It cannot be more because the jumper spring will prevent further forward movement. And it should not be less, because then, as in Figure 18 (page 10), it may not move far enough to allow the snail-arm **C-a** to drop into the next step. However, the star-wheel can only advance the surprise-piece until the pin **II** reaches the other end of the slot in the surprise-piece. And so, because we want the star-wheel to advance 15° the slot must be wide enough to achieve this. Just how far the surprise-piece advances depends on two things. First, in Figure 30 there is considerable play between the star-wheel rays and the hour-snail driver. As a result, the ray will advance about 4° before it meets the hour-snail driver and will only move it through the remaining 11° . Second, the ratio of the pitch diameters of the points where the star-wheel ray and the hour-snail driver touch will affect the relative movement of the surprise-piece, and the 11° advance of the star-wheel can be enough to advance the surprise-piece much more. In Figure 30 the ratio is about 1:2 and the surprise piece can be advanced the required 21° .

In reality, the time taken to strike 12 hours and three quarters is normally less than 15 seconds. This only requires $1\frac{1}{2}^\circ$ degrees of freedom and so the 6° allowed by Crespe seems excessive. However, allowing only $1\frac{1}{2}^\circ$ of freedom is too risky. The time taken to strike can increase significantly over time, due to increased friction from dirt, thickening oil and wear. And the repeater-spring may lose some of its strength over time, which will also slow down the striking. So a generous amount of freedom is necessary.

Finally, I must say this *quarter-snail freedom piece* is a very ingenious, very beautiful idea.

Strike timing

I have described how striking takes place, but I have glossed over one important point: *when* does striking take place?

For example, in a minute repeater striking 4 hours 21 minutes we would expect 4 hours to strike, followed *immediately* by 1 quarter, followed *immediately* by 6 minutes. And at 7 hours 47 minutes we would expect 7 hours to strike, followed *immediately* by 3 quarters, followed *immediately* by 2 minutes. But to do this a *variable* amount of time needs to be allocated to the hour and quarter striking, which may not be possible.

The entire repeater mechanism depends on the winding and unwinding of the repeater-spring by rotating the *repeater-spring arbor*. This arbor has a number of pieces mounted on it. Some are fixed, being squared onto the arbor, and must rotate with it, always taking the same amount of time to rotate. Others are loose and their movement depends on some link with one of the fixed pieces. Such loose pieces can start and stop moving at different times.

As shown in Figures 2, 3, 4 (page 3) and 6 (page 4), the continental quarter repeater has four pieces *squared* onto the repeater-spring arbor: the hour-rack **G**, the chain-pulley **z**, the quarter-rack gathering pallet **r** and the repeater-train ratchet wheel **v**. In addition, there is the *loose* first wheel of the repeater train **Z** which is linked to the ratchet wheel

The Continental Quarter Repeater

by click-work. Of these we are only interested in the hour-rack and the quarter-rack gathering pallet, the two pieces that take part in striking. Because both are squared onto the arbor, their relationship is fixed.

Figure 31 is a diagram showing the position of the repeater-spring arbor when the repeater is at rest after striking 12 hours 59 minutes. There are four points to be noted:

First, the choice of this specific time is deliberate. When the repeater-spring unwinds during striking, we do not know if it will always unwind fully. For example, at 4 hours 15 minutes it may happen that the mechanism stops immediately after striking one quarter even though there must be sufficient rotation available to strike three quarters. However, in order to strike 12 hours 59 minutes all repeaters must strike the maximum number of times and all the available rotation of the repeater-spring arbor must be used.

Second, in all repeaters the rotation of the repeater-spring and its arbor is limited to a little less than one turn; the black area cannot be used. This is caused by the quarter-rack gathering pallet, Figure 7 *r* (page 4). Before the repeater-spring arbor has rotated 360° the back of the gathering pallet will meet the quarter-rack driving pin *k* and it cannot rotate further. If it meets this pin before the all-or-nothing piece is unlocked then the repeater will *never* strike!

Third, the line labelled *pallets* shows the relative position of the hammer pallets. In fact the pallets are distributed in different places in the repeater mechanism. However, the actions of the pallets in relationship to the rotation of the repeater-spring arbor are *in principle* the same as if they were all superimposed.

Fourth, the hour-rack, squared onto the repeater-spring arbor, is shown in the center of the diagram.

When a continental quarter repeater is activated, the repeater-spring is wound by rotating its arbor anti-clockwise as shown by the arrow in Figure 31. If we ignore the effect of the all-or-nothing piece then:

- (a) First, the quarter-rack gathering pallet moves away from the quarter-rack allowing it to drop onto the quarter-snail. While this is happening the toothless part of the hour-rack is rotating past the hour hammer pallet, and so the first part of the rotation of the repeater-spring arbor is used for quarter striking.
- (b) Second, the toothed part of the hour-rack rotates past the hour hammer pallet, and so the second part of the rotation is used for hour striking.
- (c) Rotation stops when the winding-rack's hour-snail arm comes to rest on the hour-snail.

Figure 32 shows the position when the repeater has been activated at 4 hours 45 minutes. The repeater-spring arbor has rotated anti-clockwise about two-thirds of a turn before it has been stopped by the hour-snail, and all the quarters followed by 4 hours have moved past the pallets. The blue area from 5 to 12 hours has not passed the pallets and is not used.

When pressure on the push-piece is released, the arbor rotates clockwise, as shown by the arrow in Figure 32, and the hour-rack and the quarter-rack gathering pallet rotate with it:

- (a) First, 4 hours are sounded (yellow). Then there can be a short period of silence (white) while the arbor rotates until the quarter-rack gathering pallet meets the quarter-rack.
- (b) Second, three quarters strike (green).
- (c) Finally, there is another short period of silence (white) while the quarter-rack gathering pallet lifts the quarter-rack to lock it with the all-or-nothing piece.

Figure 33 shows the situation after the repeater has been activated at 4 hours 15 minutes. The only difference between this and Figure 32 is the position of the quarter-rack, which has been prevented from dropping as far by the quarter-snail. In consequence there is a larger gap between the quarter-rack and the quarter-rack gathering pallet, and so there is an extended period of silence between striking the hours and the single quarter; if striking a quarter takes 1 second then there is a delay of about 2¼ seconds.

Repeaters were meant to be used when the dial and hands could not be seen. So the user has to wait up to about 3 seconds after hour striking to determine the quarter, even when this period is silent. Clearly this is less satisfactory than a repeater which strikes the quarters immediately after the hours and it is a defect inherent in the design of this quarter repeater.

Also note that in all cases the repeater-spring arbor rotates until the quarter-rack gathering pallet raises the quarter-rack to lock it with the all-or-nothing piece. So in all cases the at-rest position is the same and as shown in Figure 31.

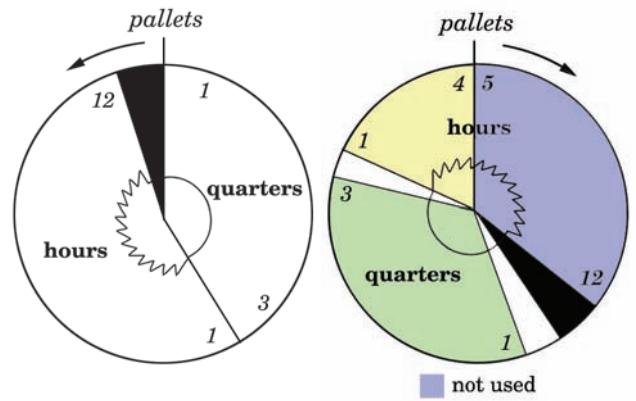

Figure 31

Figure 32

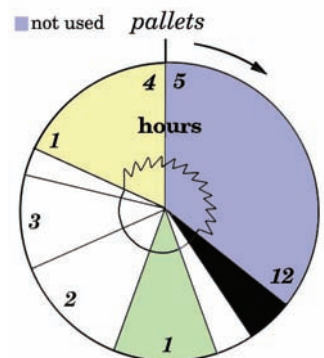

Figure 33

Hand Setting

The final point to be noted is what happens when the hands need to be set after the watch has got out of time or stopped. Will the repeater chime correctly after hand setting?

Setting the hands forward moves the repeater mechanism in exactly the same way as the normal running of the watch, only faster. And so, the hands can be set forward without any problems.

Except when moving the minute hand from after the hour to before the hour, setting the hands backward is also possible. In these cases the hour-snail and the quarter-snail freedom piece are not involved and they remain in the correct position to indicate the current hour. And because the quarter-snail is rigidly attached to the canon pinion it remains synchronised.

However, moving the hands from, say, 4h 2m to 3h 59m involves turning the hour-snail backward to the previous hour. And this action depends on the quarter-snail freedom piece and the hour-snail driver.

When a repeater is set up and adjusted, the hour-snail is positioned so that the hour-snail driver on the quarter-snail freedom piece will advance the hour-snail to the tip of a ray of the star-wheel exactly on 60 minutes. Any small error is corrected by adjusting the star-wheel jumper. Then exactly on 60 minutes the star-wheel jumps, the hour-snail advances to the next hour and the quarter-snail freedom piece advances to create the necessary zero quarter step.

However, when the hands are turned back it is the *rear face* of the hour-snail driver that moves the star-wheel. Assume we have advanced the hands to exactly 60 minutes and the hour has changed. In this position, a ray of the star-wheel is pressing against the rear face of the hour-snail driver and the hour-snail driver is holding the quarter-snail freedom piece out. If we turn the hands backward then:

- (a) The rear face of the hour-snail driver will immediately turn the star-wheel backward until the jumper reaches the point of a ray and the hour-snail jumps. This is simply the reverse of the process described earlier and the hour-snail jumps at 57½ minutes. The hour-snail starts from the position shown in Figure 18 (page 10) and turns clockwise, so during this 2½ minutes the winding-rack snail-arm will land on the previous hour step and the correct hour will sound. But if the hands are turned back to just a few seconds before 60 minutes the wrong hour could sound because of a slight inaccuracy in the hour steps or the snail arm. Also, if the edge of the snail arm lands on the edge of the previous hour step then the pressure applied on the winding rack could damage the step or the snail arm.
- (b) During the 2½ minutes that the hour-snail driver is turning the hour-snail against the pressure of the star-wheel's jumper spring, the freedom piece is held out, forming the extended zero quarter step. The freedom piece is only hidden under the quarter-snail when the star-wheel and hour-snail jump to the previous hour. So during this period no quarters can sound. If the watch is set back from 4h 7m to 3h 58m and the repeater is activated, the user will hear 3 hours 0 quarters instead of 3 hours 3 quarters.
- (c) Once the hands are turned back to a time earlier than 57½ minutes the star-wheel and hour-snail will have jumped back, and the freedom piece will be pushed back under the quarter-snail's three-quarter step by a ray of the star-wheel hitting the front edge of the hour-snail driver. Thus the repeater will be in the same state as if the hands had been turned forward to that time and it will function correctly.

A very important consequence of setting the hands backwards is that the hour-snail driver must be wide enough to ensure the star-wheel jumper will pass over the tip of the previous ray. If it did not the hour will not change and the hour-snail will no longer be synchronised with the hour hand, so the repeater will strike one hour too many from then on.

Finally, what happens if the owner of a repeater is stupid and tries to set the hands while the repeater is striking?

If the hands are adjusted by a few minutes within a quarter, there will be no problems, the quarter-snail arm simply slides along the surface of a snail step. However, in other cases the repeater can be damaged.

For example, if the owner tries to move the hands back from 16 minutes to 13 minutes while the hours are striking, the canon-pinion and quarter-snail are blocked by the quarter-snail arm and the arm will be pressed hard against the edge of the previous, zero-quarter step. If excessive pressure is applied the snail and the snail arm might be seriously damaged. Similarly, attempting to turn the hands forward while the repeater is striking 59 minutes has the same effect, the canon-pinion and quarter-snail being blocked by the snail arm.

The same problem occurs with the hour-snail. For example, if the hands are turned forward from 12 hours 59 minutes, when the hour-snail is being driven by the quarter-snail freedom piece, movement of the hour-snail is blocked and damage can occur. However, turning the hands back from just after the hour is unlikely to be a problem, because there is only a very short period of time before the hour-snail arm clears the end of the previous step, after which the hour-snail is no longer obstructed.

The Continental Quarter Repeater

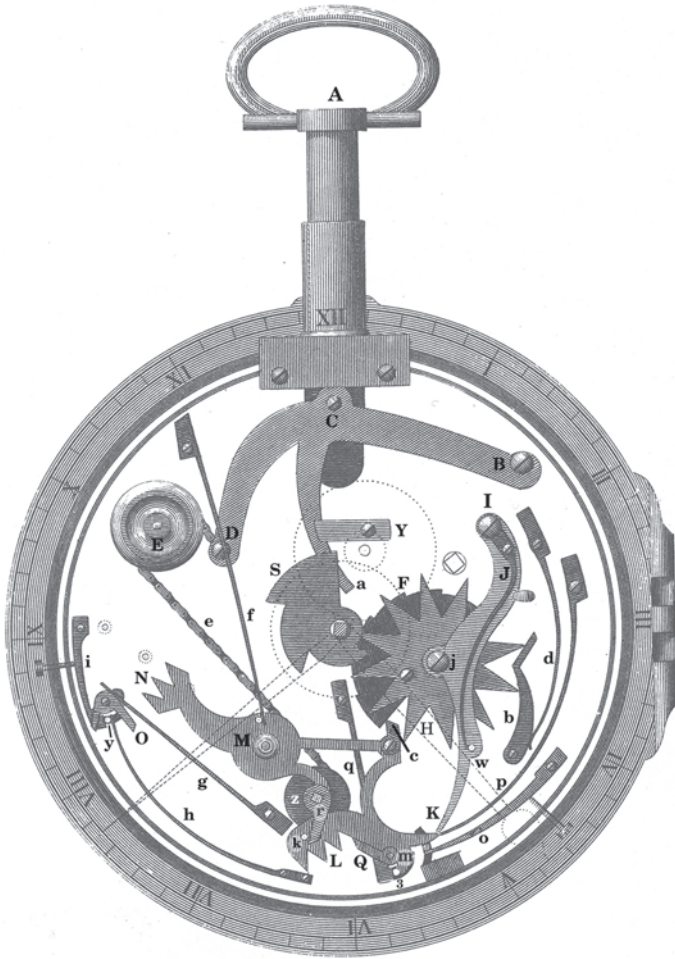

Figure 34

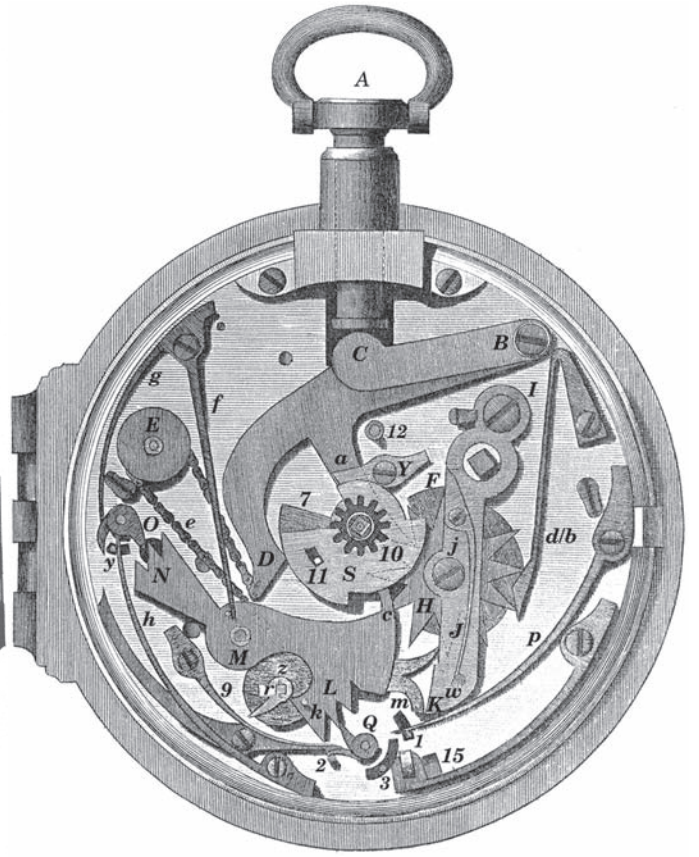

Figure 36



Figure 35

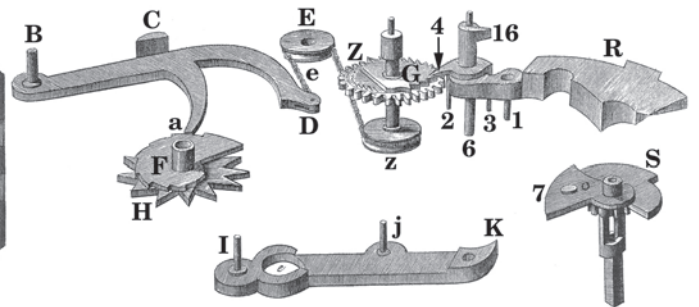

Figure 37 (view from underneath, top-plate side)

Chapter 2: Development of the Quarter Repeater

Pieces, mechanisms and calibres

In describing the continental quarter-repeater I retained the terminology commonly used by other authors. This was possible because only one design was being considered. However, there are a number of repeater mechanisms which are significantly different, and often the basic terminology is inappropriate because it misleads the reader. Consequently, I will create some new terms which better describe the functions of these pieces. Also, I will make two changes in this chapter.

The most important change is a shift in perspective. Instead of describing *pieces* I will focus on *mechanisms*.

For example, consider the all-or-nothing piece. This piece, by itself, cannot and does not prevent all incorrect striking; all it does is stop incorrect quarter striking. Wrong hour striking is prevented by the quarter-rack locking-face and the hour-pallet large-hammer lifting pin. That is to say, there is an *all-or-nothing mechanism* composed of three pieces, of which the all-or-nothing piece is just one, albeit the main one.

By shifting the focus to mechanisms, we can view pieces and their interaction coherently. For example, we can now look at a *quarter-counting mechanism* composed of a quarter-snail and an arm on a quarter-rack. And a *quarter-striking mechanism*, composed of a quarter-rack with two sets of teeth and two hammer pallets. Thus, the quarter-rack performs three, distinct tasks. Importantly, we can more easily explain mechanisms which are radically different in design, but which perform the same function. Thus we will look at a repeater where the only function of the quarter-rack is to count quarters and quarter striking is achieved by a separate mechanism.

The second, related change is that I will refer to *freedom mechanisms* throughout this chapter. That is, the *surprise piece* will be called the *freedom piece* and it will always be considered in the context of a freedom mechanism. The need for this change is obvious from the failure of other writers to explain the poorly named surprise piece. As in Chapter 1, once we rename the piece its function becomes clear.

Freedom mechanisms are necessary because repeaters use snails to count time units, and these snails are driven, continuously in the case of the quarter snail or intermittently in the case of the hour snail. Consequently, there must be situations when the arm that senses the time unit will block the rotation of the snail and cause the going train to stop or the canon pinion to slip. Thus there are two *freedom mechanisms* in the continental quarter-repeater; a quarter-snail freedom mechanism and an hour-snail freedom mechanism.

Hour-snail freedom is achieved by having a loose hour-snail held in position by the hour-snail star-wheel and its weak jumper spring, and by slightly narrowing either the snail arm or the one-hour step.

The quarter-snail freedom mechanism is more complex. Although the freedom (surprise) piece is the main part, it cannot function correctly by itself, and the mechanism uses the hour-snail star-wheel and its jumper spring to control the movement of the freedom piece. In addition, the mechanism involves the hour-snail driver. Other writers call this the “surprise-piece button”, using a meaningless name to describe something attached to another part with a meaningless name! Not only that, the hour-snail driver need not be part of the freedom piece, and we will examine a repeater where it is attached to the quarter-snail.

Also, a freedom mechanism need not use this type of freedom piece. For example, consider a quarter-rack where the quarter-rack quarter-snail arm is loose on the quarter-rack and held in position between a stop and a weak spring. Then, as it rises during striking, this arm can be pushed aside by the quarter-snail without the going train stopping or the canon pinion slipping. Such a freedom mechanism does not need a freedom piece. However, this mechanism is not satisfactory. A hinged snail arm is more likely to allow three quarters to strike on the hour, because it can more easily slip off the hour step. At the end of this chapter we will see another freedom mechanism.

The final comment concerns calibres.

The design of a repeater mechanism is constrained by the design of the watch movement to which it is added. So the calibre (layout) of a continental quarter-repeater is largely dictated by the placement of the hammers, repeater barrel and hour rack between the movement plates; their locations being controlled by the positions of the going train, escapement, mainspring barrel and fusee; the shape of the large hammer, mentioned in Chapter 1 (page 6 Figure 11), is a good example. In addition, the placement and action of the winding rack are dictated by the case pendant. And so the type of all-or-nothing mechanism and the method of releasing it are largely a consequence of the relative positions of the winding rack and the all-or-nothing piece.

Development of the Quarter Repeater

Two significant changes lead to modifications of the repeater design. First, employing a three-quarter plate movement without a fusee allows the hammers and other between-plate pieces to be relocated. (By “three-quarter plate” I mean a watch with the balance near the edge instead of near the center.) Second, activating the repeater by a button or slide on the case band repositions the winding-rack and changes its relationship to the rest of the repeater mechanism. The result is that such repeaters have a different arrangement. One important consequence is that the all-or-nothing piece can have a completely different release mechanism.

The modern quarter-repeater

Figure 38 shows a “modern” quarter-repeater and it uses most of the symbols and terminology which I used for the continental quarter-repeater. This design is not very modern. The illustration is more than 140 years old and the basic principles are exactly the same as in the old continental repeater with only a few changes that need to be explained.

First, instead of using a chain the *winding-rack* **17** (red) has teeth which mesh with a wheel **19** squared onto the repeater spring arbor. Note that the wheel **19** has one or two teeth missing to limit movement of the winding rack and to restrict rotation of the repeater spring arbor to less than one turn. A toothed winding-rack is much more reliable than a chain, which is prone to stretch and break. However, it is not new and repeaters in the early 1700s also used a geared winding-rack. According to Baillie (*Watches, their History, Decoration and Mechanism*) a chain was preferred because of the difficulty of accurately cutting the teeth so that they meshed satisfactorily.

Second, as before, there is a *repeater train* **s** (shown by dashed circles). Instead of using a delay pinion to control the rate of striking, the train ends with either a simple escapement or a centrifugal fly. The escapement, Figure 39, consists of a ratchet wheel **t** which causes a weight **w** to oscillate, and its inertia slows the repeater train. The adjustable stop **s** allows some variation of the speed.

The centrifugal fly, Figure 40, has an arm **B** mounted on the last pinion of the repeater train, and at each end of this arm there is a pivoted weight **w**, which is held near the center by the spring **a**. All is enclosed in a fixed barrel. As the repeater train speeds up, centrifugal force moves the weights outwards, increasing the momentum and slowing the train, until equilibrium is reached. Some centrifugal flies have small beaks **c** which press against the side of the barrel, the friction slowing the repeater train.

The third change is that activation of the repeater has moved from a push piece in the pendant to a slide on the case band, at about IV in Figure 38 (red). In addition, the mechanism now occupies only about half of the plate, whereas the continental repeater used the entire space under the dial. The most important consequence of this re-arrangement is that a different all-or-nothing mechanism is required. The old design depended on the all-or-nothing piece being on the other side of the hour snail **F** to the winding-rack hour-snail arm **a**, so that pressure on the hour snail would move the all-or-nothing piece detent **K** away from the quarter-rack locking-face **5**. But the new calibre has the winding-rack hour-snail arm **a** between the hour snail **F** (red) and the all-or-nothing piece **I-J-K** (green).

The modern *all-or-nothing piece* **I-J-K** is a single piece of metal with a thinned section at **J**. This section acts as a spring so that the all-or-nothing piece effectively pivots at **I**. (In Figure 38 the two springs, **o** and **p**, have their heads under the all-or-nothing piece which makes this illustration a little confusing. The all-or-nothing piece is a continuous piece occupying about a quarter of the edge of the plate from **I** to **K**.) To unlock the detent between the two locking faces **K** and **5**, the all-or-nothing piece must move outwards. To achieve this, the winding-rack hour-snail arm **a** is a separate piece attached to the winding-rack **17** by two screws **20** and **21** running in slots. Also attached to the winding-rack is the *all-or-nothing*

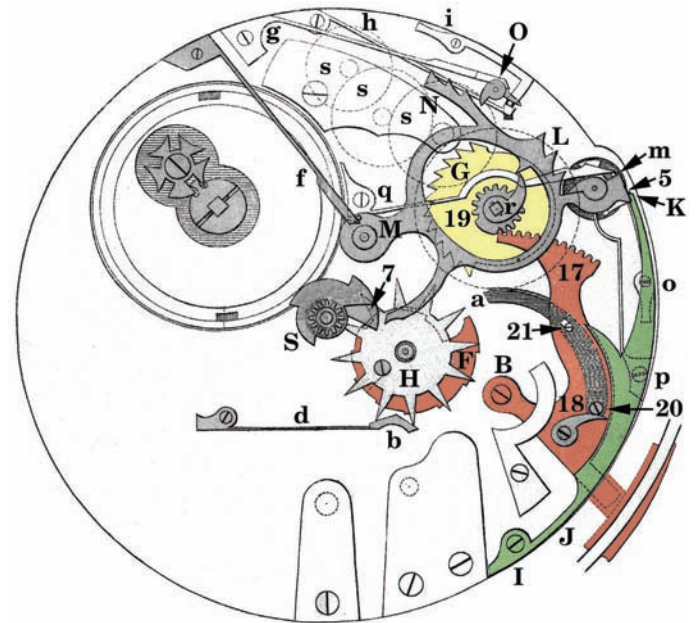

Figure 38

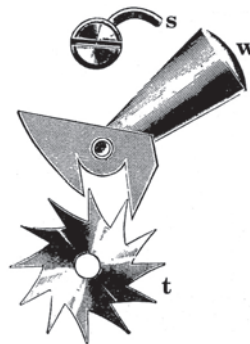

Figure 39

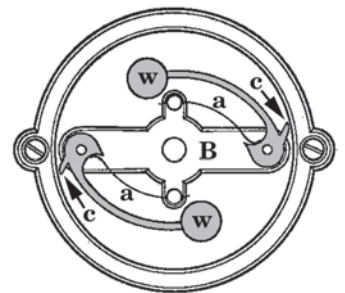

Figure 40

Development of the Quarter Repeater

piece release-pallet 18. This pallet rests against the end of the winding-rack hour-snail arm *a*, held there by the pressure of the all-or-nothing piece. When the repeater is activated and the winding-rack hour-snail arm *a* is pressed against the hour snail *F*, the winding rack *17* can continue to move until the two screws *20* and *21* are at the other ends of their slots. This additional movement forces the *all-or-nothing piece release-pallet 18* to rotate (relatively) clockwise and push the all-or-nothing piece outwards, releasing the quarter-rack. When the slide is released, the pressure of the all-or-nothing piece on the release-pallet pushes the winding-rack hour-snail arm back to its original position.

Because the distance the winding-rack travels depends on the position of the hour snail, the place where the release-pallet *18* acts on the all-or-nothing piece also changes. Consequently, the edge of the all-or-nothing piece must be an arc centered on the winding-rack pivot point *B*.

Figure 41 shows a different release mechanism. Again, the winding-rack *17* can continue to move after the winding-rack hour-snail arm *a* meets the hour snail, causing the release pallet *18* to turn (relatively) anti-clockwise and so push the all-or-nothing piece outwards. (Figure 41 is a simplification to show the all-or-nothing piece mechanism. As drawn there is nothing to stop the winding-rack hour-snail arm *a* from flopping about anti-clockwise with serious consequences. There must be a stop to hold it against the release pallet *18*.)

The rest of the modern quarter-repeater is the same as the continental quarter-repeater. The all-or-nothing mechanism consists of the quarter-rack release mechanism described above, and the quarter-rack locking-face *m* for the hour-pallet lifting pin. The freedom mechanisms for the two snails are the same, consisting of a freedom piece *7* for the quarter snail with the hour-snail driver mounted on it, and a star-wheel *H* and jumper *b* for the hour snail. The hour rack and the hammer pallets are also the same.

Finally, because the basic design is the same as that of the continental quarter-repeater, the strike timing is the same as that shown in Figures 31, 32 and 33 of Chapter 1. That is, there is a variable period of silence after striking the hours before the quarters strike, depending on the number of quarters to be struck.

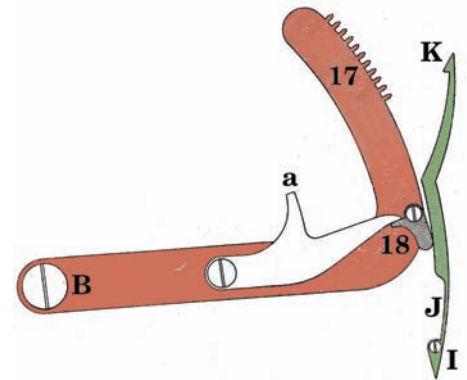

Figure 41

The modern simplified quarter-repeater

Because repeaters are very complex and very expensive to make, simplified mechanisms have been produced. The one shown in Figure 43 has three features:

First, the quarter-racks which we have seen so far perform two functions, *counting* and *striking* quarters. In the simplified repeater these functions are handled by two different mechanisms and the quarter-rack is replaced by a *quarter-counting piece 22*.

Second, the hour-rack is replaced by a *strike-rack G* which strikes both the hours and quarters.

Third, the all-or-nothing mechanism is completely omitted and there is nothing to prevent incorrect striking if the winding rack is not moved far enough.

Figures 42 and 43 show the relevant parts; the actions of the winding-rack, hour snail, etc, are the same as in other repeaters.

The strike-rack, Figure 42 *G*, is squared onto the repeater-spring arbor and has 12 hour-striking teeth and two sets of 3 quarter-striking teeth, *N* and *L*. When the repeater is activated, the strike-rack rotates anti-clockwise so that all the quarter striking teeth *L* and the necessary number of hour striking teeth pass the large hammer pallet *Q*. When the strike rack returns clockwise, as the repeater-spring unwinds, the hours are struck followed by the quarters. The teeth *N* are longer than the other teeth and the small hammer pallet *O* is set further from the strike rack than the large hammer pallet *Q*. Consequently the pallet *O* misses the hour teeth and the quarter teeth *L* and is only moved by the longer teeth *N*. Note that this mechanism needs only two hammer pallets instead of the three necessary for the continental quarter-repeater.

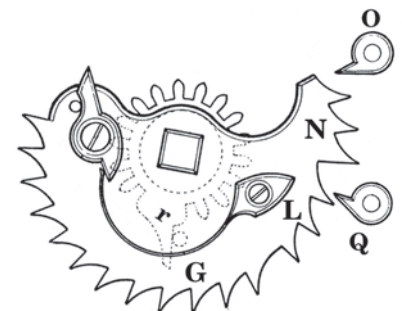

Figure 42

It is apparent that unless there is some additional mechanism the strike rack will always strike three quarters no matter what time is shown on the dial.

Development of the Quarter Repeater

Quarter striking is controlled by the *quarter-counting* piece, Figure 43 **22**, and its *gathering-pallet* r' . The gathering-pallet butts against one of the four teeth of the quarter-counting piece. In Figure 43 the mechanism is effectively jammed and the strike-rack **G** cannot rotate any further clockwise, because the quarter-counting piece is pressed up against its stop **23** and the gathering-pallet is wedged between a tooth of this piece and its stop **24**. Consequently, if the repeater is in this state no quarters can be struck because the strike-rack cannot rotate further clockwise, and so the quarter teeth **N** and **L** cannot move past the pallets. In fact, Figure 43 illustrates the *at-rest* state after a full hour and no quarters have been struck, with the gathering pallet against the first tooth of the quarter-counting piece.

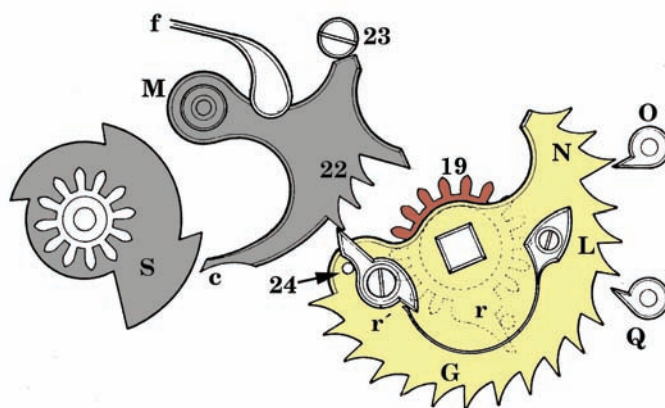

Figure 43

In general, the *at-rest* state of the mechanism is with the quarter-counting piece **22** against its stop **23**, and the gathering-pallet r' wedged between its stop **24** and any one of the four teeth of the quarter-counting piece. This position is maintained by the remaining torque in the repeater spring.

When the repeater is activated by the slide, the winding-rack rotates the strike-rack **G** anti-clockwise. This causes the gathering pallet r' to move away from the quarter-counting piece **22**, releasing it, and it drops onto the quarter-snail under the pressure of its drop-spring **f**. The strike-rack continues rotating until the winding-rack is arrested by the hour snail (not shown in Figure 43).

When the slide is released, the hours are struck in the same way as in any other repeater. After the hours have struck, the strike-rack continues to rotate clockwise and the gathering-pallet r' meets one of the four teeth of the quarter-counting piece **22**. Which tooth it meets depends on which step of the quarter snail the quarter-counting piece drops onto. If the quarter-counting piece drops onto the 3-quarter step, then it will have rotated further and the gathering-pallet will meet the last tooth on it. And the quarter-counting piece will be a correspondingly larger distance from its stop **23**. As the strike-rack continues to rotate, the quarter-counting piece will be moved back to its stop and 3 quarters will be struck before the mechanism is again wedged and unable to rotate further. In general, the hammer pallets **O** and **Q** will be in front of, behind or between the strike-rack quarter-teeth, depending on the *last* quarter struck.

It is important to note that there must be as many teeth on the quarter-counting piece **22** as quarters to be struck (including the silent “zero” quarter). Further, these teeth must be spaced so that the movement of the gathering pallet r' from one tooth to the next corresponds exactly to the movement of one quarter-striking tooth (**N** or **L**) past the hammer pallet.

One last detail is that the strike-rack **G** is driven by the gathering piece r -**19**; in Figure 38 r and **19** are separate pieces. This piece is a wheel **19**, mounted loose on the repeater-spring arbor, with a finger that meshes with a pin on the strike-rack. It is turned by the winding-rack and, in its turn, it winds the repeater-spring indirectly through the strike-rack, which is squared onto the repeater-spring arbor. This is done to isolate the winding-rack from the repeater mechanism so that the repeater does not have to raise the winding-rack as well as perform its other functions. Instead, the winding-rack, and its slide or push piece, can have their own spring to return them to the at-rest position independently of the repeater mechanism. It also ensures that the winding mechanism can always return to the same position, usually leaving a gap between gathering piece finger and the pin it acts on.

The modern, simplified quarter-repeater is anything but modern! Figure 44 is an illustration of one from a book published nearly 270 years ago (Thiout, *Traite de l'Horlogerie Mecanique et Pratique*).

This repeater uses a single hammer and has a single hour-quarter striking pallet **Q**. The *quarter-counting piece* **22** (green) looks like an arm with a hand, and some books call it a *hand* and refer to its *fingers*; terms which are as silly and meaningless as the “surprise” piece. It functions in the same way as the repeater in Figure 43, but there is a simple pin r' (white) instead of the gathering-pallet.

Development of the Quarter Repeater

When the repeater is activated by the winding-rack (red), the strike-rack **G** (yellow) rotates clockwise and the three quarter-striking teeth (hidden under the quarter-counting piece) and the necessary number of hour striking teeth move past the hammer pallet. The gathering pin **r'** rotates the quarter-counting piece **22** anti-clockwise until its arm **c** meets the quarter-snail **S**. Then the strike-rack continues to rotate until the pin is free from the "fingers" of the quarter-counting piece. The "hand" of the quarter-counting piece is loose and held in position by a spring. This is to enable the "hand" to rotate until the pin is free, even if the quarter-counting piece is in contact with the snail. The quarter-counting piece must have a stop like **23** in Figure 43, but it is not shown.

Striking is the same as in the previous simplified repeater. In particular, the at-rest position depends on the last quarter struck; in Figure 44 it was the second quarter.

Although archaic, the *hand* has been used in modern repeaters. Baillie *Watches, their History, Decoration and Mechanism* illustrates one, which he erroneously describes as "modern quarter repeating work". See also Richard French, *Servicing a Quarter-repeater*, *Horological Journal*, April 2004, 133-138.

Finally, why is the all-or-nothing mechanism omitted? As with the other repeaters I have described (see for example Figure 38) the only way we know that correct striking will occur is when the winding-rack snail-arm **a** contacts the hour snail. Referring to Figure 43, it is only then that we can be sure that the strike-rack has rotated far enough anti-clockwise. If this does not happen, then the only way to prevent incorrect striking is to hold *both* hammer pallets **O** and **Q** away from their hammers. That is, when the winding-rack snail-arm contacts the hour snail a detent must be released which allows a *sideways* movement to free the pallets, in the same way that the quarter-rack locking face **m** moves in Figure 38. Equally important is that the reverse sideways movement must occur when the mechanism returns to its at-rest position and not before. But in Figure 43 neither the strike-rack **G** nor the quarter-counting piece **22** can be used, because both start moving as soon as the winding-rack is activated. Consequently, in addition to an all-or-nothing piece an entirely new piece would have to be added to achieve this movement. Assuming this can be done, the result would be a repeater mechanism more complex than the normal quarter-repeater, which would defeat the purpose of having a simplified design. So the all-or-nothing mechanism is omitted, not just to simplify the mechanism, but because the design makes its inclusion impractical.

Strike timing in the simplified quarter-repeater is different from that in the continental and modern quarter-repeaters, because it uses a single strike-rack squared onto the repeater-spring arbor. Figure 45 shows the at-rest position of the strike-rack after the repeater has struck 12 hours 45 minutes, and Figure 46 shows the position after the repeater has been wound (anti-clockwise) ready to strike 12 hours 45 minutes. With respect to the hour pallet **Q**, the shaded area is unused and only a little more than half a turn of the repeater-spring arbor is required. Striking occurs when the arbor rotates clockwise and the 12 hour-teeth, followed by the two sets of 3 quarter-teeth, move past the hammer pallets, returning to the position in Figure 45.

From the form of the strike-rack it is clear that:

- (a) Quarter striking takes place immediately after hour striking; in fact there is a slight gap to provide a sort period of silence.
- (b) Three quarters will strike unless the rotation of the repeater-spring arbor is arrested before all the quarter-teeth have passed the pallets.

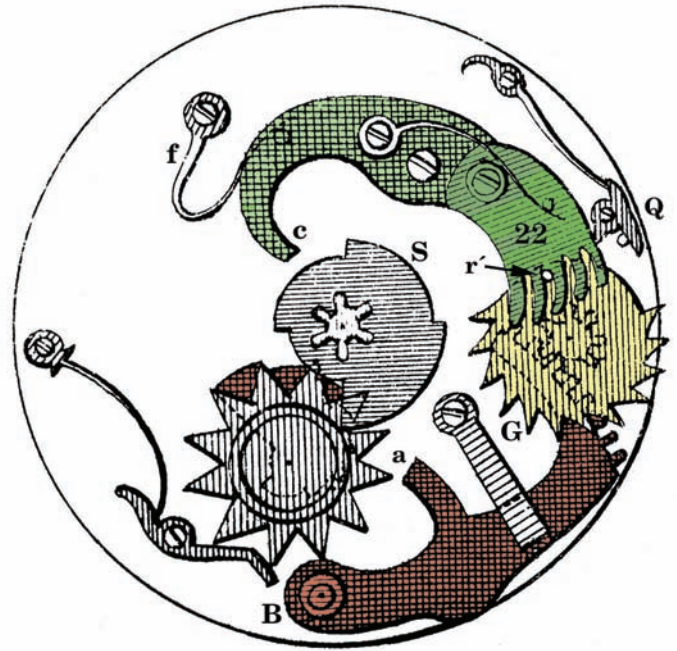

Figure 44

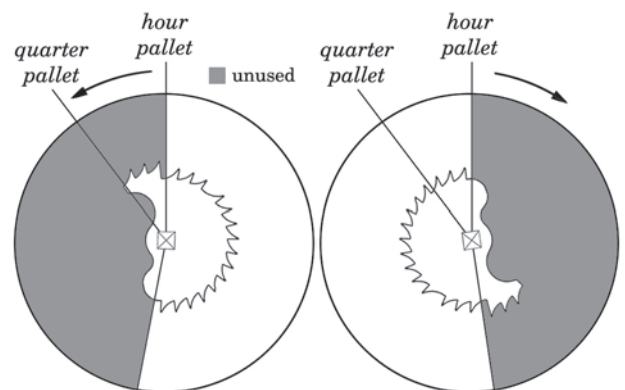

Figure 45

Figure 46

Development of the Quarter Repeater

Figures 47 and 48 show the action at 4 hours 15 minutes. When the repeater is wound anti-clockwise, Figure 47, all three pairs of quarter teeth and four hour teeth move past the hour pallet *Q*, at which point movement is arrested by the winding-rack snail arm meeting the hour-snail.

When the repeater strikes, Figure 48, the repeater-spring arbor rotates clockwise. First, the four hour teeth strike the hour on *Q* (yellow) and then, after a short delay (white), the quarter teeth strike one quarter (green) on both pallets *Q* and *O*. At this point rotation of the arbor is arrested because the quarter-counting piece meets its stop. In fact, when the repeater is at rest, the position of the strike rack tells us how many quarters were struck when it was last activated.

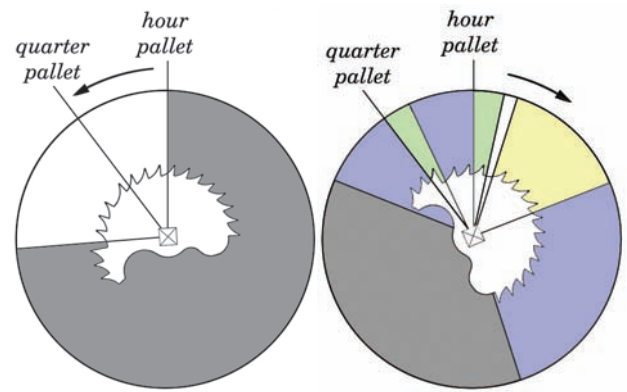

Figure 47

Figure 48

So, although the simplified quarter is not as good as the quarter-repeater, because it does not have an all-or-nothing mechanism, it is superior because striking takes place without a long delay between the hours and quarters.

Half-quarter and five-minute repeaters

The quarter-repeater can be adapted to be a half-quarter ($7\frac{1}{2}$ minutes) or five-minute repeater fairly easily.

In the half-quarter repeater the counting mechanism is altered by replacing the 4-step quarter-snail by an 8-step half-quarter snail. Then the quarter striking mechanism with two sets of 3 teeth is replaced by a half-quarter striking mechanism with two sets of 7 teeth. Otherwise the repeating mechanism is unchanged; in particular, the same all-or-nothing and freedom mechanisms are used.

This repeater strikes the hour followed by 0 to 7 half-quarters, and the listener has to become proficient at interpreting the half-quarter sounds.

Exactly the same method can also be used for 5-minute repeaters. In this case the quarter-snail is replaced by a 12-step 5-minute snail and the quarter striking mechanism is replaced by one with two sets of 11 teeth. Thus the repeater strikes the hour followed by 0 to 11 five-minutes, which is even more difficult for the listener to interpret.

It must be noted that, as in Figure 43, the quarter-rack gathering piece *r* can only move through a little less than one turn, less than 360° . This is because the back of the gathering piece meets the quarter-rack driving-pin which prevents further rotation (and this is true of all the repeaters we have looked at). As part of the rotation of the gathering piece is reserved for hour striking, the remaining part of a turn must be sufficient to release 7 or 11 teeth. Consequently, these teeth must be small enough so that the angular space taken up by them is no more than that available.

In the continental quarter-repeater described previously, the hour rack was cut 12 in 24. That is, the rack has 24 teeth of which 12 are removed, and hour striking requires a full half turn of 180° . So half-quarter or 5-minute striking must take place in less than half a turn. However, the hour rack could be cut differently. For example, if it is cut 12 in 36 then only one third of a turn, 120° , is needed for hour striking and more time and space is made available for quarter, half-quarter or 5-minute striking; as in Figure 43.

Also note that the teeth on a strike rack are placed on the circumference of a circle centered on the rack's pivot point. In the continental quarter-repeater, described in Chapter 1, the pivot point of the quarter-rack is a long way from the center of the movement, and so only a few teeth can be placed on that part of a circle that lies inside the movement frame. In addition, in Figure 38 the quarter-rack teeth *N* lie on a circle with a smaller radius than the teeth *L*. In order to have more teeth, the pivot point has to be moved closer to the center of the movement.

In the case of a simplified half-quarter-repeater based on Figure 43, the strike-rack must have 26 teeth cut on it; 12 hour teeth and two sets of 7 half-quarter teeth. In addition, the half-quarter-counting piece must have 8 teeth or "fingers". Even worse, the simplified 5-minute repeater would need 34 teeth on the strike-rack and 12 teeth on the 5-minute-counting piece.

A far better mechanism would be one in which the number of half-quarters or 5-minutes after the *last quarter* is struck. For example, at 2h 52m the above 5-minute repeater would strike two hours followed by ten 5-minutes; the half-quarter-repeater will strike two hours and six half-quarters. In contrast the proposed mechanism would strike two hours, three quarters and one 5-minute; or two hours, three quarters and no half-quarters.

The improved half-quarter-repeater is a much more complicated mechanism. It uses a separate *half-quarter-snail* rigidly attached to the quarter snail, and a separate *half-quarter-rack* mounted on and linked to the quarter-rack. This half-quarter mechanism enables a single blow for the half-quarter after the hours and quarters have struck.

Figures 49 and 50 show one arrangement. Only the racks, snails and hammer pallets are illustrated because other parts of the repeater remain the same.

Development of the Quarter Repeater

The half-quarter snail S' , which is above the quarter-snail, has four steps with the edges of the steps aligned to the half-quarters at $7\frac{1}{2}$, $22\frac{1}{2}$, $37\frac{1}{2}$ and $52\frac{1}{2}$ minutes; these are marked by the fine lines. The fine lines on Figure 50 mark the full quarter points. The steps of the half-quarter snail are higher than the quarter-snail steps during the first $7\frac{1}{2}$ minutes of each quarter, and the same height during the second $7\frac{1}{2}$ minutes of the quarters. The *half-quarter-rack* A (grey) sits above the quarter-rack B (yellow) and pivots freely on the same axis M as the quarter-rack. It has only one tooth C which acts on the small-hammer. This tooth, depending on the snails, can stand free causing an extra strike, or be super-imposed over the last quarter-rack striking tooth and have no effect. The two racks are linked by the *jumper-spring* D mounted on the quarter-rack and acting on the pin 2 on the half-quarter-rack. This spring ensures the half-quarter-rack is held in one of two positions relative to the quarter-rack, with its tooth active or inactive (super-imposed over the last quarter-rack striking tooth).

The at-rest positions of the two racks is when the two locking faces E and m are aligned and resting against the large-hammer quarter-pallet, with the quarter-rack locking face m acting on the hour-pallet lifting pin 3 to keep the hour pallet out of mesh with the hour-rack. This is the same arrangement as shown in Figure 49, but before the racks have dropped. In the at-rest position the half-quarter tooth C is exposed and the ends of the half-quarter rack snail arm and the quarter rack snail arm are aligned.

Both racks drop together under the action of the quarter-rack drop-spring f acting on the pin I mounted on the quarter-rack, the half-quarter-rack dropping because of the linking spring D . What then happens depends on the position of the snails:

- (a) Figure 49. A half-quarter is struck if the steps of the half-quarter snail S' and the quarter snail S (underneath, shown by the dotted lines) are at the same height. In this case the motion of both racks is arrested at the same time because the half-quarter rack snail-arm and the quarter-rack snail-arm are aligned and both meet their respective snails simultaneously. Consequently, the fourth, half-quarter tooth remains exposed. The quarter-rack gathering piece r raises the quarter-rack, striking the quarters. The half-quarter-rack rotates with it and strikes a half quarter. The motion of the two racks is halted at the same moment because the quarter-rack hour-pallet locking-face m and the half-quarter-rack stop at E are aligned. The half-quarter is distinguished from the quarters because it is struck on only one gong.

- (b) Figure 50. A full quarter is struck when the steps of the snails are at different heights, the half-quarter step being higher than (outside) the quarter step. The half-quarter-rack arm is stopped by its snail while the quarter-rack continues to drop onto its snail under the pressure of its drop spring f . This extra movement causes the jumper spring D to slip to its other position and the fourth tooth C is hidden above the third quarter-rack tooth. The quarter-rack gathering piece r raises the quarter-rack, striking the quarters. The half-quarter-rack rotates with it and no half quarter is struck. The motion of the half-quarter-rack is halted first because its stop E is in advance of the quarter-rack hour-pallet locking-face m . The quarter-rack continues to rotate until it is stopped, forcing spring D back to its original position and again exposing the half-quarter tooth.

Finally, screw G acting in a slot helps keep the two racks together. Its slot and the hole through which pin I acts limit the movement of the half-quarter-rack.

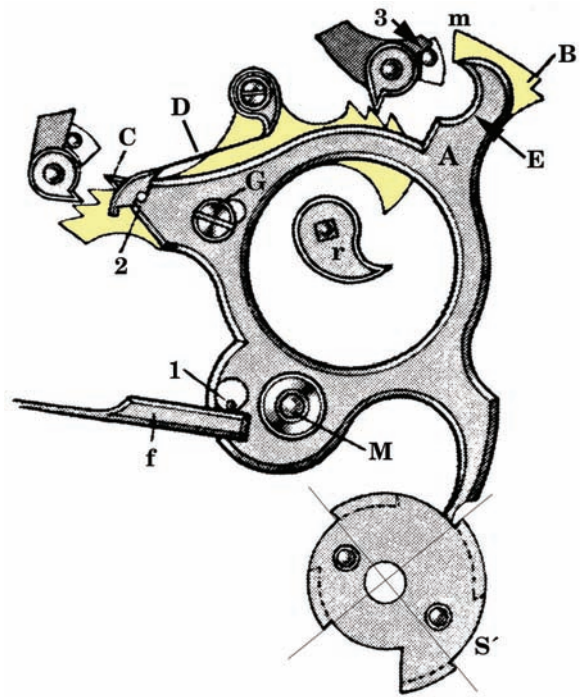

Figure 49 Half quarter position

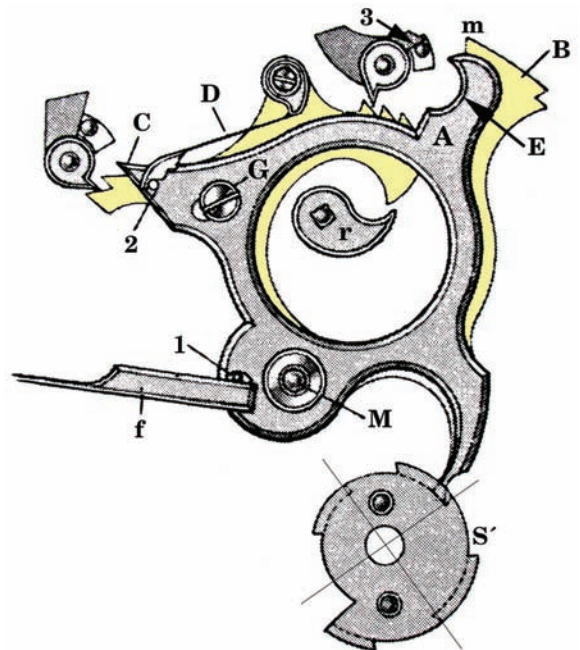

Figure 50 Full quarter position

Development of the Quarter Repeater

Figures 49 and 50 are taken from Lecoultré *A guide to Complicated Watches*. Lecoultré does not mention the freedom mechanism, but one must exist and it should act on both the quarter and half-quarter snails. Both snails are rigidly attached to the canon pinion and both are continually turning. So at 59m 55s the quarter-rack and half-quarter-rack snail arms drop into the deepest steps of their respective snails and both must be able to rise up without hindering the rotation of the canon pinion.

As explained in Chapter 1, the quarter and half-quarter points are determined by the trailing edges of the snail arms (the edges closest to the previous snail step). So the three-quarter steps must be enlarged by at least the width of the snail arms plus, say, 6° for freedom; a total of about 21° or 3½ minutes. Thus the three-quarter steps are at least 111° wide and the hour steps are reduced to at most 69°. In this regard, Lecoultré has drawn the snails correctly, as shown by the fine lines superimposed on Figure 50, which mark the quarter divisions.

Throughout the zero-quarter, from 0 to 15 minutes, the quarter-rack drops the same distance, and whether a half-quarter is struck or not depends on the movement of the half-quarter rack. That is, the quarter rack *always* drops far enough for a half quarter to strike, which means that the space occupied by the half-quarter tooth *always* passes the hammer pallet. The other quarters are, of course, the same.

On the hour or zero-quarter, the half-quarter snail *S'* is larger than the quarter snail *S*, so that the further movement of the quarter-snail arm will hide the half-quarter tooth *C*. So a freedom piece *7* that acts on the half-quarter snail as well as the quarter snail must be like that in Figure 51, in order to mimic the snail steps and stop the half-quarter arm before the quarter arm.



Figure 51



Figure 52

An alternative freedom piece is shown in Figure 52. (This is illustrated in de Carle *Complicated Watches and their Repair* as part of his description of a half-quarter-repeater, but his explanation is obscure and partly wrong.) As I have noted, the quarter-rack and quarter snail are designed so that the space occupied by the half-quarter tooth *C* always passes the hammer pallet. This happens even on the hour, when the larger diameter of the half-quarter snail moves the tooth *C* out of this space and superimposes it over the first quarter-strike tooth, which has not passed the hammer pallet. The freedom piece *7*, in Figure 52, stops the quarter rack dropping far enough, so that the space for the half-quarter tooth remains *behind* the hammer pallet. In this situation it doesn't matter whether the tooth *C* is exposed or not because it cannot cause the hammer to strike. If, later in the first half-quarter, the snail arms land on the snails instead of the freedom piece, correct striking will occur as described in (b) above.

Although Figure 52 is a simpler freedom piece, it is logically incorrect, because it does not mimic the action of the snails.

First, because the zero-quarter steps have been cut back and the freedom piece does not have a lip on the level of the half-quarter snail, the half-quarter rack drops into an open space and is not supported. This works because the position of the half-quarter rack is immaterial and it is supported by the quarter-rack through the jumper-spring *D*. Figure 53 shows a better freedom piece which overcomes this objection.



Figure 53

Second, in both Figures 52 and 53, instead of the rack arms counting the correct number of quarters and half-quarters, the racks are effectively disabled and prevented from counting. Nothing will strike, not because there is nothing to strike, but because nothing can be struck. Everything else in a repeater serves a function that is logically correct in the context of the action of the mechanism. As far as I am concerned, although it is a simple, effective solution, it is not pleasing.

These different freedom piece designs reinforce the very important point that the purpose and action of *every single part* of a repeater mechanism must be understood. Without knowing *exactly* how the mechanism works, it is very easy to misunderstand how parts behave. Equally important, unless we take great care when reading descriptions and examining illustrations we will not know whether they are correct or not.

To illustrate this, Figure 54 is a half-quarter-repeater made by Barraud, London, circa 1835, which appears to be the same as the half-quarter mechanism described above, but it is significantly different.

To begin with, five points should be noted:

First, the half-quarter is struck by the large-hammer.

Second, the winding-rack uses an intermediate wheel *E* to wind the repeater spring; the wheel is held by the steel bridge which goes over the half-quarter rack jumper spring *D*. This wheel is necessary to enable the winding-rack to rotate the repeater-spring anti-clockwise.

Third, the all-or-nothing piece detent *K* acts on the quarter-rack quarter-snail arm (which is underneath the half-

Development of the Quarter Repeater

quarter snail arm c). This change is necessary because the cock below K (which is part of the escapement) prevents the all-or-nothing piece extending to the quarter-rack hour-pallet locking-face m (under C) where the detent would normally be placed.

Fourth, although difficult to see from the photograph, the half-quarter rack is not a complete oval, as in Figure 49, but a segment extending from the jumper D , through the pivot point M , to the tooth at C . Which is why it is attached to the quarter rack by the two screws on its snail arm c' , both of which run in elongated holes.

Also, the half-quarter rack appears to have two teeth at C instead of one and it does not appear to have a locking face to butt up against the hammer pallet, without which it cannot function properly. It would seem that the half-quarter rack could rotate further clockwise until the screws on the snail arm are at the other ends of their holes. In which case the second “tooth” could move past the hammer pallet and strike a second time incorrectly.

Fifth, the winding rack hour-snail arm a appears to be the full width of the hour-snail steps. Also note, from the position of the star-wheel jumper b , that this photograph shows the repeater just before the hour when the freedom piece 7 is rotating the star-wheel.

As explained in Chapter 1 (page 11), the arm a is normally at most half of the width of the hour-snail steps, because immediately before the hour the snail has moved half the width of a step and the jumper b is at the tip of a ray of the star-wheel. So at 12h 59m the arm a would land on the one hour step of the snail and the repeater would then strike 1 hour and 3 quarters instead of 12 hours and 3 quarters. This repeater presumably uses the alternative arrangement of the hour-snail and star-wheel where the XII step of the snail is cut 45° wide and the I step reduced to 15°. (This has been described in detail in Chapter 1; see Figure 22 and the accompanying text, page 12.)

Photographs can be misleading and it is not possible to be certain how this repeater works, especially because the XII and I steps of the hour-snail are hidden under the all-or-nothing piece. If we had the actual watch and operated it, we would be able to see features that are not clear from the photograph. But what is important is that we should take the time and care to learn as much as possible about every repeater we see or handle.

Two things that we *can* see are very interesting. The half-quarter snail S' is quite different from that in Figures 49 and 50, being the same size as the quarter-snail S during the first half-quarter. And the edge of the freedom piece 7 can be seen, and it clearly acts on both snails. So how does it work?

As the action of this repeater is the same as the repeater in Figures 49 and 50, only the behaviour of the snails and snail arms will be considered.

The at-rest position is the same as in Figure 49, with the half-quarter tooth C exposed, except that *the end of the half-quarter rack snail arm is in advance of the quarter-rack snail arm by the depth of one step on the snails.*

Consequently:

- (a) Figure 55. Unlike Figures 49 and 50, a half-quarter is struck if the steps of the snails are at different heights, the half-quarter snail (shaded) being smaller. In this case the motion of both racks is arrested at the same time because the half-quarter rack snail-arm is in advance of the quarter rack snail-arm and both meet their respective snails simultaneously. Consequently, the fourth, half-quarter tooth remains exposed.

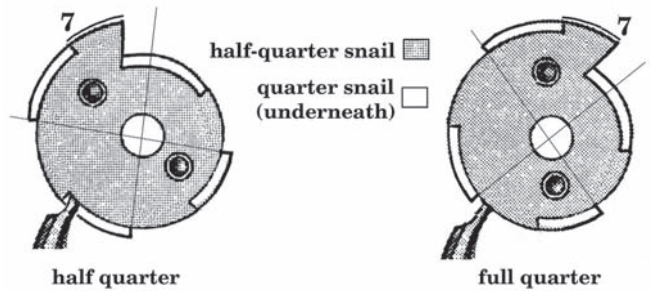

Figure 55

Figure 56

- (b) Figure 56. A full quarter is struck when the steps of both snails are at the same height. The half-quarter-rack arm, being in advance, is stopped by its snail while the quarter-rack continues to drop onto its snail under the pressure of its drop spring. This extra movement causes the jumper spring D to slip to its other position and the fourth tooth is hidden above the third quarter-rack tooth.



Figure 54

Development of the Quarter Repeater

- (c) The freedom piece 7 has a raised lip outside the hour step which goes up to the level of the half-quarter snail (this lip can be seen in Figure 54). There must be a lip because, as in (b) above, the half-quarter rack has to be stopped while the quarter-rack continues to move, in order to hide the half-quarter tooth C.

Figure 53 shows, in profile, the quarter snail *S* and half-quarter snail *S'*, both rigidly attached to the canon pinion. The freedom piece 7 with its raised lip is loose on the canon pinion. Unlike with the repeater in Figures 49 and 50, in this context the freedom piece is logically correct.

It is important to be aware that the half-quarter snails in Figures 49 and 55 count half-quarters *relative to* the quarter snail. That is, counting depends on the half-quarter snail step being on the same level as, or one step deeper than, the corresponding step on the quarter-snail. And the movement of the half-quarter rack is *relative to* the quarter-rack.

It is tempting to say that the improved 5-minute repeater mechanism is now obvious. The 5-minute rack would have 2 teeth and the jumper-spring *D* would be held in any of three positions. Then the 5-minute snail is divided to allow the 5-minute rack to be held in any of the three positions. Remembering that this snail functions *relative to* the quarter snail, it would be shaped as in Figure 57 with each step covering 30°.

However, it is not that simple. The two 5-minute teeth are correspondingly smaller and *both* must be hidden by the last quarter-striking tooth when no 5-minute interval is to be sounded. The hammer pallet must then be longer, so that it can reach the shorter 5-minute teeth, or a separate 5-minute pallet added.

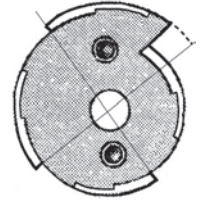

Figure 57

State transitions, timing and hand setting

The half-quarter and five-minute repeaters I have described are all modifications of the quarter-repeater. Two simply replace the quarter-snail by a half-quarter or five-minute snail. The third is a quarter-repeater with an added half-quarter snail and half-quarter rack. Consequently, at this point these repeaters can be considered together.

The behaviour at state transitions during hour striking is the same as that in the continental quarter repeater, described at Figures 27 and 28 in Chapter 1 (page 13). At all transitions except that to the next hour, the sub-hour (quarter, half-quarter or 5-minute) counting mechanism is free and held in position by its drop spring. So, if the snails and hands advance to the next state, the snail arms will drop onto the next step of the snails and one more time unit will be sounded. If the state transition occurs after the hours have struck, then the sub-hour counting mechanism is being driven by its gathering pallet and cannot drop onto the next step. Thus, if a repeater is activated at 11h 29m 55s it will strike appropriately for 11h 30m. But if it is activated a little earlier then it will strike appropriately for 11h 29m.

Just before the hour, the snail arms are on the lowest step of the snails and cannot advance, ensuring correct striking at this time.

In addition, these repeaters have the same strike timing behaviour as a quarter-repeater, shown in Figures 31 to 33 of Chapter 1 (page 17), there being a variable, and sometimes quite long, period of silence after striking the hours before striking the 5-minutes or half-quarters. This is particularly bad at, for example, 4 hours 7½ minutes, when the listener must patiently wait a few seconds for the single, belated 5-minute or half-quarter strike.

Likewise, setting the hands of the quarter, half-quarter and five-minute repeaters is the same as setting the hands of a continental quarter repeater. All use the same quarter-snail, freedom piece, hour-snail and star-wheel mechanisms, and so setting the hands backwards to just before an hour will cause incorrect striking.

As with the continental quarter-repeater, setting the hands of these repeaters while they are striking is dangerous and must not be done for the same reasons.

Chapter 3: Minute Repeaters

The minute repeater

A minute repeater strikes the hours and quarters followed by one stroke for each minute after the last quarter. It is considered to be very complex and hard to comprehend, but it is no more difficult than the repeaters we have already examined, because it consists of features derived from those mechanisms.

The minute repeater is also very old, and Figure 58 is an illustration of one from about 260 years ago.

In addition to the quarter-snail S , there is a *minute-snail* S' mounted on the canon pinion. This snail has four arms corresponding to the four quarters, and each arm has 15 steps for striking the 0 to 14 minutes within each quarter.

There are two, superimposed racks pivoted at M , to count and strike the quarters (red) and minutes (yellow). Counting is by the quarter-rack snail arm c dropping onto the quarter snail, and the minute-rack arm c' dropping onto its snail. The quarter rack has two sets of 3 teeth L and N to strike the quarters using the hammer pallets Q and O , and the minute rack has one set of 14 teeth N' to strike a high note for each minute. (Actually a soft note because gongs were not invented until about 1790. The minutes are softer because the minute striking teeth are smaller and raise the hammer less.) The drawing is wrong, because the minute-rack has only 11 teeth!

The basic action of this mechanism is the same as the previous repeaters. Winding by the geared winding-rack, pivoted at B , is limited by the hour-snail arm a , and the all-or-nothing piece I - j - K (green) is unlocked by the pressure of this arm on the hour snail.

Both the quarter and minute racks drop together onto their respective snails, thus moving the appropriate number of teeth past the hammer pallets; f is the drop spring for the quarter-rack and I assume f' is the drop spring for the minute-rack. (The original illustration is not labelled and is a bit strange.) J , as in the continental quarter-repeater and the repeater in Figure 54 is the spring that presses the all-or-nothing piece inwards to maintain the lock on the quarter-rack; in the same way as the integral spring J in Figures 38 and 41 (page 22). 3 is the slot for the hour-pallet lifting pin; but here it is the minute-rack that keeps the pallet out of mesh with the hour-rack to prevent incorrect hour striking, instead of the quarter-rack. g and q are the quarter-pallet return springs. The fanciful, spider-like thing at O is probably two separate quarter- and minute-striking pallets, one on top of the other. Either the minute-snail S' is too large or the minute-rack arm c' is too long; the arm cannot drop far enough to let sufficient minute-striking teeth past the pallet O .) Note that both snails are drawn incorrectly and both need freedom mechanisms.

How minute striking is achieved is unclear. The quarter-rack is raised by the gathering pallet r and quarter striking proceeds as explained before. But the minute rack must rise and strike *after* the quarters have sounded. However, the quarter-rack rises much further than necessary to clear the quarter-snail and the pallets, and it could have a pin underneath it that lifts the minute-rack, although where this invisible pin could be is unclear. That is:

- When the winding rack rotates the gathering pallet anti-clockwise and unlocks the all-or-nothing piece, the quarter-rack drops, releasing the minute-rack so that it also can drop. At this point the gathering pallet r is towards the top of the slot in the quarter-rack.
- After striking the hours, the gathering pallet (rotating clockwise) meets the pin on the quarter-rack, rotates it and the quarters strike. At this point the quarter-rack is outside the quarter-snail, the gathering pallet is in the middle of the slot in the quarter-rack (so that the quarter-rack can continue to rise), the minute-rack is still resting on the minute snail, and the invisible pin on the quarter-rack meets the minute-rack.
- The gathering pallet continues to rotate the quarter-rack clockwise and it, through the invisible pin, lifts the minute rack to strike the minutes.

Before we look at minute repeaters in more detail, two important features should be noted.

First, unlike the half-quarter snails in Figures 49 (page 27) and 55 (page 29) of Chapter 2, the minute-snails in Figures 58 and 59 are *independent*. Counting minutes is achieved without regard to the position of the quarter-snail, and the movement of the minute-rack is independent from the movement of the quarter-rack. Consequently a different mechanism is required to drop and raise the minute rack correctly.

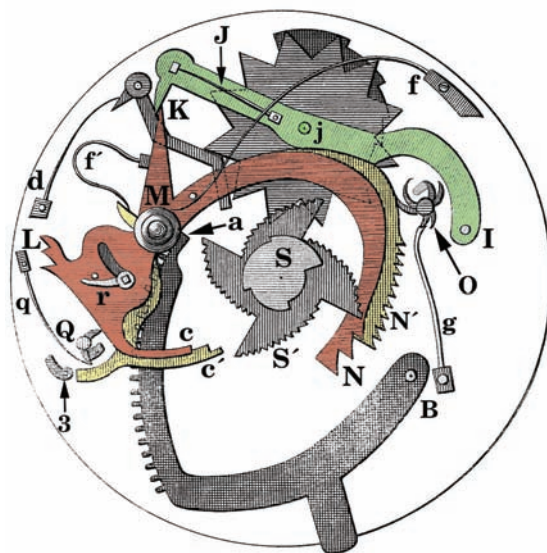

Figure 58

The Minute Repeater

Second, there are two strange features in Figure 58. The most obvious is that the quarter-snail S is about 45° out of alignment with the minute-snail S' and correct striking would seem to be impossible; when the minute-snail moves from striking 14 minutes to striking no minutes, the quarter-snail is in the middle of a step. This is probably another drawing error. The other feature is much more subtle. In all the repeaters we have examined (for example Figures 43, page 24, and 49, page 27) the racks pivot at M and their snail arms move in an arc centered on this pivot point and with a radius of the distance from M to the center of the canon pinion. That is, the face of the snail arm is tangential (square) to the steps of the snail. Consequently, if there are two super-imposed racks, their snail arms are also super-imposed. However, this is not the case in Figure 58, where the radius of the minute-rack snail-arm c' is too large and the face of the arm passes outside the canon pinion. This is not simply an error because other minute repeaters exhibit the same type of arrangement; in Figure 59 the minute-snail arm c' passes through the center of the canon pinion, but the quarter-snail arm c passes inside it. As everything in a repeater has a reason, it should be possible to find an explanation for these oddities.

The minute repeater in Figure 59 is basically the same as that in Figure 58, but now the method of counting and striking minutes is explained. The hour striking and all-or-nothing mechanisms are not shown because they are the same as those described previously. The complete mechanism of such a watch is shown in Figures 60 and 72 (page 37), however the direction of movement of the racks is reversed. (In both photographs the snail arms c and c' have been outlined to make them clearer.)

Figure 59 shows the repeater during striking, just after the quarters have struck and before the minutes are sounded. The at-rest state is the same, but with the racks rotated anti-clockwise until the quarter-rack hour-pallet locking face m is pressed against the large-hammer lifting-pin 3 , and the detent n is locked by the all-or-nothing piece. (The repeater in Figure 60 is a little different. The quarter-rack locking face m acts on an arm of the pallet Q , and the hour-rack G is between the winding-rack 17 and the plate. The one pallet Q serves for both hour and quarter striking.)

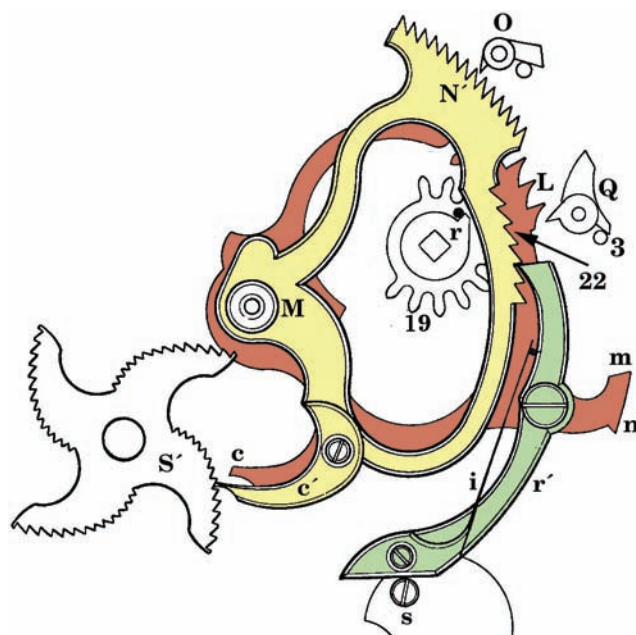

Figure 59

Unlike the repeaters shown in Figures 38 (page 22) and 49 (page 27), the quarter-rack in this repeater must rotate a large amount. This is because all striking must finish before the quarter-rack is locked by the all-or-nothing piece; at that point rotation of the repeater-spring arbor must cease. So after quarter striking, the quarter-rack must be able to rotate far enough to allow for 14 minutes to strike. In this repeater, the gathering pallet r , squared onto the repeater-spring arbor, acts on a pin mounted on a loose wheel 19 on the repeater-spring arbor and the teeth of this wheel mesh with teeth cut on the quarter-rack. The wheel must be loose because it cannot rotate until the all-or-nothing piece releases the quarter-rack and then the amount it rotates depends on the position of the quarter-snail. Thus it must be independent of the rotation of the repeater-spring arbor.

Activating the repeater rotates the gathering-pallet r clockwise (anti-clockwise in Figure 60). When the quarter-rack is released by the all-or-nothing piece, it rotates clockwise around its pivot M and its snail arm c drops onto the quarter snail under the pressure of a drop spring, with the correct number of quarter-striking teeth move past the hammer pallets.

The movement of the minute-rack is more complex. It also drops, rotating clockwise around the same pivot M , under the pressure of a separate minute-rack drop-spring, until its snail arm c' meets the minute snail S' , and the correct number of minute-striking teeth N' move past the small-hammer pallet O . But how this happens depends on the positions of the snails and the minute-rack.

The minute-rack gathering mechanism consists of the gathering pallet r' (green), mounted on the quarter-rack (red), and the minute-rack gathering teeth 22 . The gathering pallet r' is normally held in mesh with the teeth by its spring i acting on a pin mounted on the quarter-rack; so the minute-rack cannot drop until the quarter-rack drops. When the quarter-rack drops, the end of the gathering pallet meets the fixed pin at s and it is forced to rotate clockwise (anti-clockwise in Figure 60), releasing the gathering pallet from the gathering teeth. This happens just before the snail arm c reaches the position of the zero quarter step. If arm c drops onto another step, the outer edge of the gathering pallet slides past pin s . So, no matter what step of the quarter-snail is used, the gathering pallet r' will be held away from the minute-rack gathering teeth 22 .

The Minute Repeater

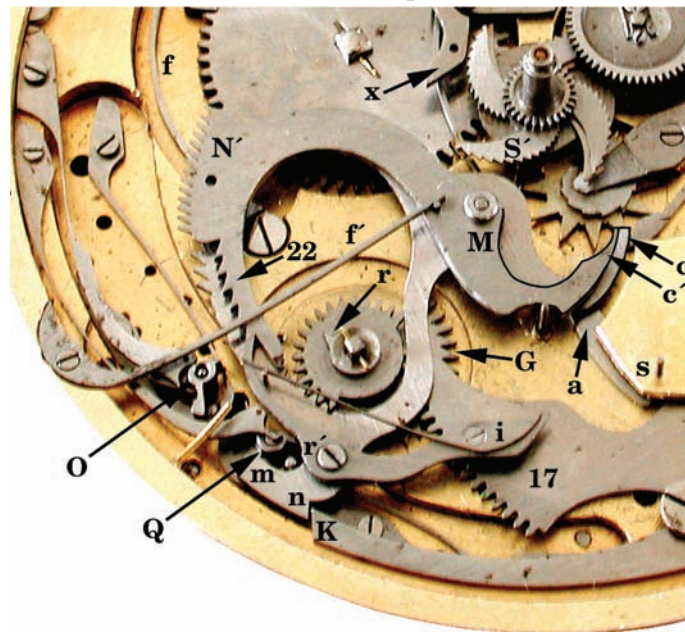

Figure 60

When the minute-rack drops with the quarter-rack there are two possible situations:

- (a) If the quarter-rack reaches its snail before the minute-rack, then the gathering pallet r' must have moved away from the minute-rack gathering teeth 22 and the minute-rack is free to continue dropping onto its snail.
- (b) Because the minute-snail is larger than the quarter-snail, the minute-rack can be stopped by its snail before the quarter-rack has reached the outermost step of its snail. In which case the quarter-rack keeps dropping and the gathering pallet r' will slide over the gathering teeth 22 until it is lifted away from them by the pin s .

Striking the hours and quarters occurs normally. The hours strike first, and then the quarter-rack gathering pallet r reaches the pin on the wheel 19 that drives the quarter-rack. The quarter-rack is raised and the correct number of quarters are struck. During this process, the minute-rack gathering pallet r' is held away from the minute-rack gathering teeth 22 and the minute-rack does not move. It is not until *after* the quarters have struck that the outer edge of the minute-rack gathering pallet slides off the pin s and meshes with the minute-rack gathering teeth. The minute-rack only starts moving when this happens and it then strikes the number of minutes indicated by the snail. Both racks rotate together until the quarter-rack is locked by the all-or-nothing piece.

Strike timing is similar to the quarter-repeater because the hour and quarter mechanisms are the same. The at-rest position, Figure 61 is always the same with the quarter-rack fully raised and locked by the all-or-nothing piece; corresponding to having struck 12 hours, 3 quarters and 14 minutes. However, the position of the minute-rack depends on the number of minutes last struck.

Figure 62 shows the repeater ready to strike 4 hours 21 minutes with the clockwise (winding) rotation stopped by the hour-snail. Striking (anti-clockwise) consists of the 4 hours (yellow), a period of silence corresponding to 2 quarters (white), 1 quarter (green), 6 minutes following immediately after the quarter strike (red), and finally a long period of silence while the quarter-rack is raised and locked. The at-rest position of the minute-rack is with all its teeth past the hammer pallet, but how far past depends on which of the minute-rack gathering teeth was used, and so on the number of minutes which have just been struck.

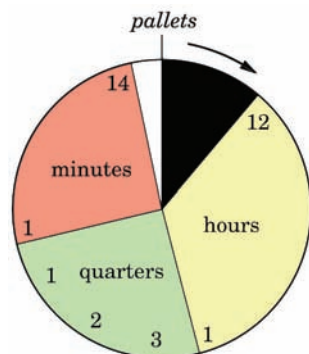

Figure 61

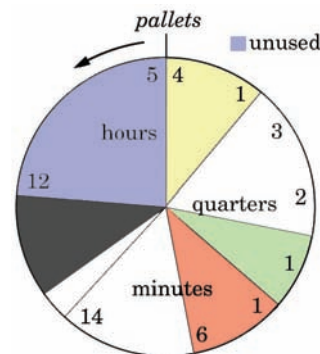

Figure 62

The Minute Repeater

Finally, three points should be noted.

First, the function of the gathering mechanism here is quite different from that used for the simplified quarter-repeater in Figure 43 (page 24) and the simplified minute repeater to be described next. In those mechanisms the gathering teeth **22** count the quarters and minutes respectively and control their striking; and so they must have the same number of teeth as quarters or minutes to be struck. However, in Figures 59 and 60 there are only 7 minute-rack gathering teeth, not 14. This is because minute counting is performed by the minute-rack's snail arm c' and its 14 hammer striking teeth N' , and the gathering teeth have nothing to do with it. Their only purpose is to move the minute-rack back to its at-rest position with all the striking teeth past the pallet O . Because the distance the minute-rack must move varies considerably, from resting on the zero minute step of the snail to resting on the 14-minute step, a simple pin will not work and the gathering teeth are used instead. Provided the rack moves far enough, it does not matter if it moves a little further in some cases; and using fewer, larger teeth, with more certain action, is preferable.

A consequence of using 7 gathering teeth is an interesting variation in strike timing. When striking odd numbered minutes the minute-rack gathering pallet will land on one of the gathering teeth further away from the acting face of the tooth than is the case when striking even numbered minutes. Consequently, there is a slightly longer pause between striking the quarters and the minutes! However, I very much doubt if this would ever be noticed.

The second point is that an alternative form of minute-rack gathering pallet is often used when the hammer pallets and hammers are arranged differently, as shown in Figure 63. The function of the gathering pallet is the same as in Figure 59, but it is disengaged from the gathering teeth **22** in a different way. Instead of using a pin s , the gathering pallet r' is raised by the arbor of the large hammer Q .

The third point is that both the quarter-snail and the minute-snail must have freedom mechanisms. But before describing them we shall look at another minute repeater.

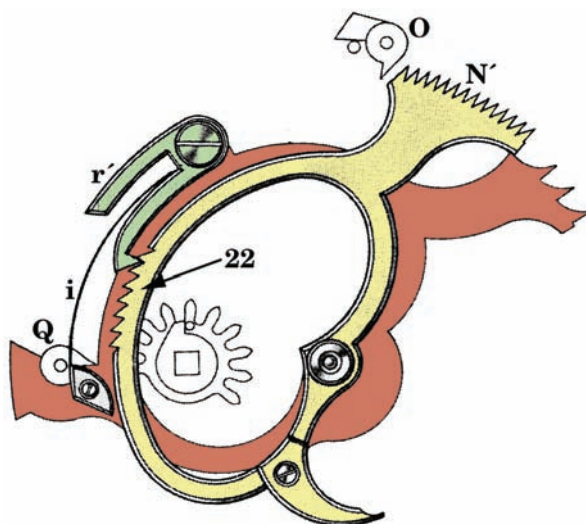

Figure 63

A simplified minute repeater

The principles of the minute repeater in Figure 64 are similar to those of the simplified quarter-repeater, although it is naturally more complex.

This repeater has a single *quarter/minute strike-rack* $L-N-N'$, like the hour/quarter strike-rack of the simplified quarter-repeater, and a *minute-counting piece* **22** to control minute striking. The illustration shows the repeater during striking, just after the quarters have struck and before the minutes are sounded.

When this repeater is activated, the quarter/minute strike-rack and minute-counting piece drop, under the pressure of their respective drop springs f and f' , moving anti-clockwise onto the quarter and minute snails in the same way as in the repeater in Figure 59. In particular, the behaviour of the minute-counting piece gathering-pallet r' is the same; when the quarter/minute strike-rack drops onto the quarter-snail, pin s moves the gathering-pallet out of mesh with the gathering teeth **22**, freeing the minute-counting piece. As before, if the minute-counting piece reaches its snail before the quarter/minute strike-rack, the quarter/minute strike-rack continues to drop and the gathering pallet r' slides over the teeth **22** until it is raised out of the way.

The Minute Repeater

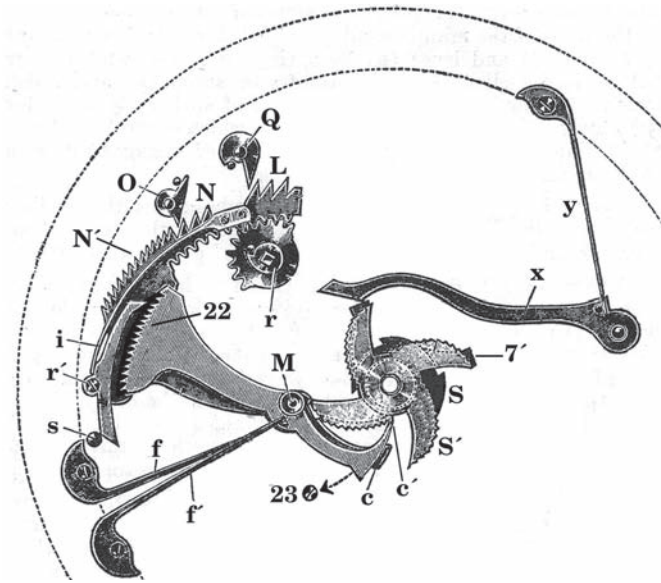

Figure 64

After the hours have struck, the gathering pallet *r* raises the quarter/minute strike-rack which strikes the required number of quarters using the quarter-strike teeth *L* and *N*. During this time the minute-counting piece remains free and rests on the minute snail. After quarter striking, the minute gathering pallet *r'* slips off the pin *s* and goes into mesh with the teeth **22** under the pressure of its spring *i*. Then the quarter/minute strike-rack and the minute-counting piece continue to rotate clockwise together while the minutes are sounded.

As with the simplified quarter-repeater in Figure 43, the motion of the minute-counting piece is arrested by the stop **23**. This also causes the quarter/minute strike-rack and its quarter/minute strike teeth to stop, because the gathering pallet *r'* prevents it rotating further. In this at-rest position the number of minute-striking teeth *N'* that have passed the hammer pallet is the number indicated by the minute-snail and the minute-counting teeth **22**. Like the simplified quarter-repeater, it is necessary that there are 15 minute counting teeth and that the space between them corresponds to the spacing of the minute striking teeth *N'*.

Strike timing is now clear.

Figure 65 shows the at-rest position after striking 12 hours 59 minutes (actually, it applies to any number of hours). Figure 66 is the position when the repeater is activated at 4 hours 21 minutes and winding is stopped by the hour-snail. During striking there is an extended period of silence (white) between the hours (yellow) and the single quarter (green), and then the minutes strike immediately (red). After the 6 minutes have struck the minute-counting piece is locked and rotation of the repeater-spring arbor ceases. Consequently, the new at-rest position is that shown in Figure 67.

Figure 68 shows the worst case situation for 4 hours 1 minute. After the hours strike (yellow) there is a long period of silence (white) before a single minute strike (red). The user has to be alert throughout several seconds of silence to hear the minute strike, which is often very quiet because the minute strike teeth are very small and so only lift the hammer a small distance.

Finally, adding an all-or-nothing mechanism to this repeater has the same problems as occur with the simplified quarter-repeater.

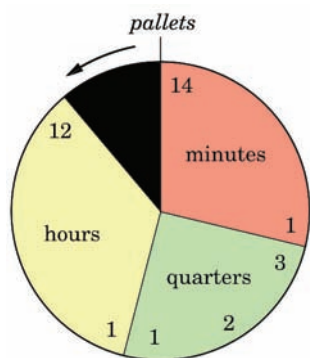

Figure 65



Figure 66

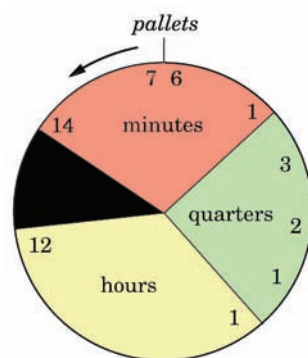

Figure 67

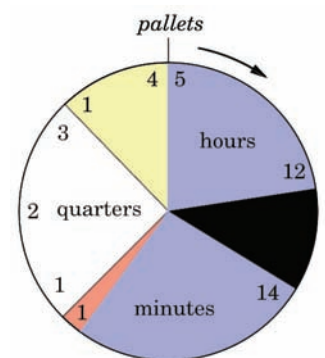

Figure 68

Minute repeater freedom mechanisms

As we have seen, a repeater is very complex; indeed, it is the most complex mechanism that can be added to a timepiece. However, it is not magical. It is simply a machine made up of wheels, levers and springs which obey mechanical laws. But because it is so complex, to appreciate what happens when the push piece is depressed or the slide moved requires understanding a sequence of events and the interactions of all the parts. I have stressed the need for a complete understanding because otherwise the mechanisms will not make sense or will be misinterpreted, especially when the purpose and action is not obvious. And this is most likely to happen with freedom mechanisms.

Wherever there is a snail there must be a freedom mechanism. So a minute repeater requires three freedom mechanisms for the hour, quarter and minute snails. Both of the minute repeaters in Figures 59 and 60 use the same hour-snail freedom mechanism that has been described in the first chapter. The *minute-snail freedom mechanism* (often called a *guard*) is shown in Figures 64 and 69.

The outer, zero-minute step of the minute-snail S' , Figure 64, is cut back to about a fifth of its correct width or removed completely. A four-arm *minute-snail freedom piece* $7'$ is mounted loose on the canon pinion between the quarter-snail and the minute-snail. Its movement is limited by an appropriate hole and pin, in the same way that the movement of a quarter-snail freedom piece is restricted. The position of the freedom piece is controlled by its own jumper x and jumper spring y (Figures 64 and 70).



Figure 69

The jumper is positioned so that:

- Before the end of a quarter, as shown in Figure 64, the freedom piece is held back, under the zero, one and two minute steps, and 14 minutes can strike.
- On the quarter-hour, the jumper x rides over the back of the freedom piece and snaps it forward to fill the zero-quarter step, as in Figures 69 and 70. The jumper must hold the freedom piece in this position for about 3 minutes to ensure that the freedom piece does not drop back and prevent the minute-snail arm from reaching the one-and two-minute steps. Note that the minute-snail's zero-minute step is never used and it can be completely removed.

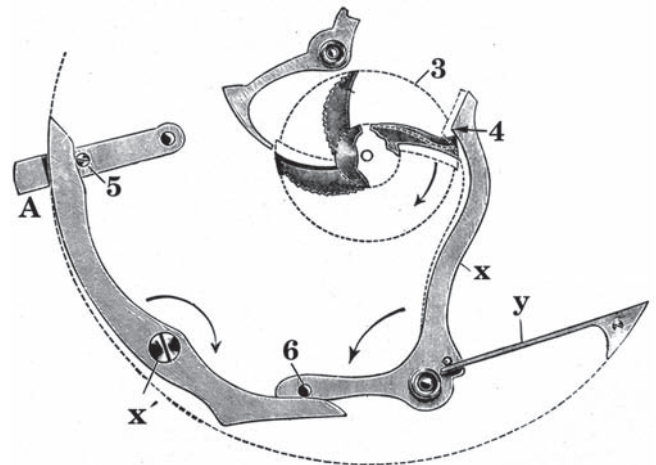

Figure 70

Thus the behaviour is the same as that of a quarter-snail freedom piece.

The jumper x can exert an unwanted pressure on the canon pinion and affect the running of the going train. Also, it and the tips of the freedom piece $7'$ are prone to wear. So some minute repeaters have an additional lever which holds the jumper x away from the freedom piece except when the repeater is activated. This lever, the *freedom piece isolator* x' , is moved by the winding rack. Figure 70 shows one arrangement where the repeater is activated by a lever or slide in the case band.

When the repeater is at rest, pin 5 on the winding rack A holds the isolator x' rotated in an anti-clockwise direction. At the same time, the isolator presses on pin 6 mounted on the freedom piece jumper x , rotating it clockwise against the pressure of its spring y . This holds the jumper away from the freedom piece.

When the repeater is activated by moving the winding rack A clockwise, pin 5 releases the isolator x' , allowing it to rotate clockwise so that the jumper x can drop and control the freedom piece.

As shown in Figure 70, the isolator x' does not move the jumper x completely away from the freedom piece. If it did, the freedom piece could flop around, in which case the jumper x might land on the outer face of the freedom piece and cause the repeater to strike incorrectly. So the tip 4 of the jumper must always lie within the circle 3 (which marks the extremity of the freedom piece) to ensure the freedom piece is correctly positioned at all times. Thus the isolator reduces but does not completely overcome the problems for which it is designed.

This difficulty can be solved by modifying the freedom piece as in Figure 71, which is a view from underneath. A weak spring 2 is mounted on the freedom piece which acts on a pin 1 , mounted on the minute snail S' and passing through a hole in the freedom piece. This spring keeps the freedom piece held back over the 0 and 1 minute steps so that the 14

The Minute Repeater

minute step is accessible, and the freedom piece will only move out when the jumper x acts on it. With this modification the isolator x' can hold the jumper x outside the circle \mathcal{B} so that the jumper only acts on the freedom piece when the repeater is activated.

Whether all this effort to produce a functional isolator is justified or not is questionable. The isolator spring, Figure 70 y , should be very weak and so friction, wear and the impact on the going train should be small.

The above explanation of the minute repeater freedom mechanism (which is what we will find in the books by de Carle, Hillmann and Lecoultré) is satisfactory but incomplete, because the quarter-snail freedom mechanism is not mentioned. It might be reasonable to assume that the same type of quarter-snail freedom piece is used as in other repeaters, but this is not the case.

The minute repeater in Figures 60 and 72 is basically the same as that in Figure 59. This is an eight-day travelling clock, but it is, in fact, just an overgrown pocket watch. It is in an open-face pocket watch case 4 inches (100mm) in diameter and the movement is about 2.25 inches (55 mm) in diameter. Being very large, it is much easier to examine.

The watch is pendant wound and has rocking-bar keyless work 30 . To allow for eight days running, the mainspring barrel is very large and the second wheel, which is normally in the center of the movement and carries the canon pinion, is placed off-center. Consequently, the canon pinion is mounted loose on a stud and instead of driving the motion work it is driven. The wheel 31 is mounted friction tight on an extended arbor of the going train. The hour and minute wheels have been removed, but 31 drives the minute wheel mounted on the stud 32 . The minute wheel, in turn, drives the canon pinion and a pinion on it drives the hour wheel. This design has a potentially serious problem. If there is any play in the motion work gears then the canon pinion, snails and minute hand will have play, which might affect striking on the hour. Other than this the movement is normal.

The repeater is activated by pushing in the crown at C . The winding-rack pivots at B and uses levers on the right side to transfer the movement to the winding-rack teeth 17 and the hour-snail arm a . As with all of the other minute repeaters (Figures 59, page 32, and 64, page 35), the snail arms c and c' are not superimposed. There is no minute-snail freedom piece isolator.

However, there is one strange feature; there is no quarter-snail freedom mechanism. As the underneath view of the canon pinion in Figure 73 shows, the quarter-snail has the hour-snail driver 8 mounted on it instead of on the missing freedom piece. So this repeater should not function correctly just before and after the hour. But it does!

How it works is not obvious when the repeater is examined with the canon pinion and its snails in place; too much of what we want to see is hidden underneath other parts. When the canon pinion is taken out we find something strange; the minute snail is rigidly attached to the canon pinion but the quarter-snail is *loose*. Indeed, the minute-snail freedom piece and the quarter-snail are screwed together and both are loose, their movement restricted to about 12° or two minute-snail steps. This is, in fact, mentioned in passing by the three books I have referred to, but none of the authors offer any reason for it and they completely ignore the quarter-snail freedom mechanism in such repeaters.

To understand how the snails and the freedom piece work, Figures 74 and 75 show the parts just before and just after the quarter.

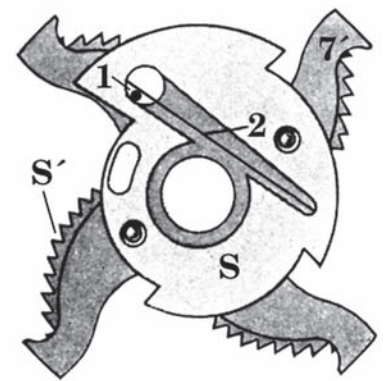

Figure 71

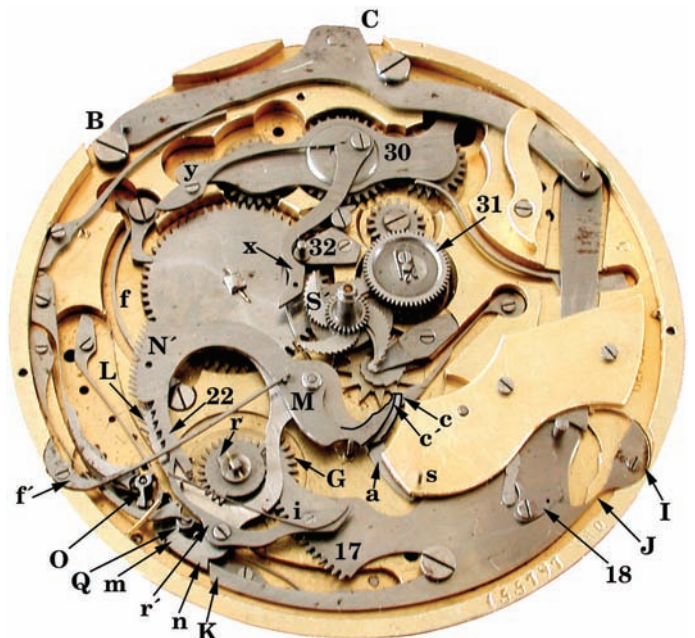

Figure 72

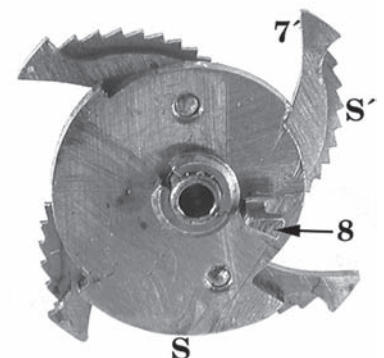

Figure 73

The Minute Repeater

These illustrations are deliberately mirror images. Viewed normally from the dial side, as in Figure 69, the three pieces mounted on the canon pinion are, from top to bottom, the minute snail S' (fixed), the freedom piece $7'$, and the quarter-snail S (both loose but joined together). Figures 74 and 75 are, in effect, a view from the dial side, but with the order of the pieces reversed; the quarter-snail on top and the minute snail underneath. This enables us to see all three parts and their relationship.

The lines 15, 30, 45 and 60 mark the four quarters and correspond to 15, 30, 45 and 60 minutes on the dial. These lines, which are determined from the fixed minute snail, are arcs centered on the pivot point M of the racks and passing through the center of the snail (Figures 60 and 72). The arms c and c' move along these arcs, with the quarter-rack snail-arm c passing behind the center of the snail.

The lines 0, 1, 2 and 3 mark the start of the quarter-snail steps, line 0 showing where the start of the zero quarter would be if all the steps were 90° wide. Irrespective of the position of the quarter-snail and the attached freedom piece, the quarter-snail does not line up with the quarters on the dial, and is between about 5° , when the freedom piece is exposed, and about 15° , when the freedom piece is hidden, behind the quarter points.

In the top-right of each illustration I have shown the position of the minute-rack snail arm c' at 4m 59s and 5m 0s; to avoid having to include additional illustrations, I have rotated the minute rack around the canon pinion instead of rotating the canon pinion. Immediately before 5m the arm drops on the end of the four-minute step, and it has the same relative position at every change of minute, with the trailing edge of the snail arm determining the minute points. In particular, at 59m 59s the arm drops onto the very end of the fourteen-minute step, which it can only do if the following zero-minute step has been cut back by at least the width of the arm c' .

Immediately before the hour, at 59m 59s, the snail arms land on their respective snails in the positions shown in Figure 74. The minute-snail arm c' (bottom), shown in the process of dropping, has its trailing edge just behind the zero-minute line and the quarter-snail arm c is immediately in front of it. Because both the freedom piece and the quarter-snail are held back by the freedom piece jumper, there is sufficient space for the snail arms to drop onto the innermost steps.

Exactly on the hour, Figure 75, the freedom piece and the quarter-snail flip forward. The minute-snail arm c' lands on the freedom piece just in front of the zero-minute line and the quarter-snail arm c , which is in advance of the minute-snail arm, now lands on the zero-quarter step of its snail. Thus the quarter-snail freedom mechanism is built into the quarter-snail itself and no separate freedom piece is needed. And the hour-snail driver 8 now only serves to move the hour-snail.

Exactly the same behaviour occurs for all quarters. Not only does this create the necessary freedom for the minute-snail, but it also ensures that the quarter-snail arm lands on the right step of its snail.

Finally, a separate quarter-snail freedom piece could be used, as in the other repeaters we have looked at. However, in this case the canon pinion would have four pieces mounted on it; from top to bottom, the minute snail (fixed), the minute-snail freedom piece (loose), the quarter-snail (fixed), and the quarter-snail freedom piece (loose). This is considerably more complex and difficult to make, and unnecessary.

Indeed, the combined minute- and quarter-snail freedom mechanism in the minute repeater is, like the quarter-snail freedom mechanism in the quarter-repeater, a very ingenious idea.

But does it work?

Achieving hour and quarter freedom is easy. Because the steps of the snails are wide, there is no difficulty in cutting back the one-hour and zero-quarter steps and having wide, solid snail arms.

In contrast, minute-snail freedom is very difficult because the steps of the snail are small. The minute snail is made as large as possible, to maximise both the width and depth of the steps, the latter controlling the size of the minute striking teeth N' . However, each step is one minute or 6° wide and, as is clear from Figure 76, the width of the 14-minute step should be $\frac{1}{60}$ th of the circumference a circle whose radius is the distance from the center of the canon pinion to the step. In the case of the travelling clock in Figures 60 and 72, the width is about 0.012 inch (0.3 mm).

As explained above, it is the trailing edge of the minute-rack snail-arm c' that determines the minute points. So one second before the start of the next quarter the arm protrudes into the space for the zero minute and that step must be cut

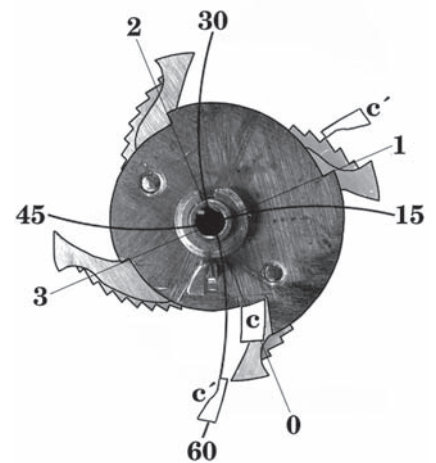

Figure 74

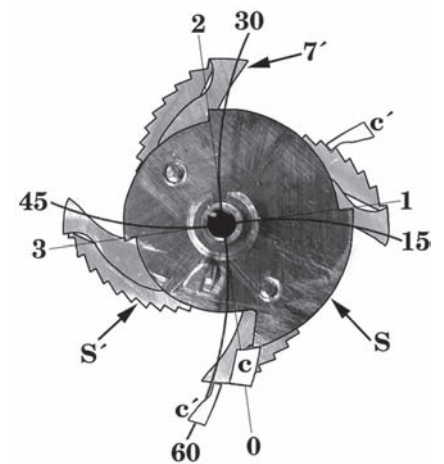

Figure 75

The Minute Repeater

back by the width of the arm plus whatever amount is necessary for freedom. In Figures 59 and 60, the zero minute step is cut back to about one-fifth of its correct width, or 1.2° , so that the 14-minute step is enlarged by 4.8° to about 10.8° wide. If striking takes 15 seconds in the worst case of 12h 59m 59s, then about 1.5° ($\frac{1}{4}$ of 60 seconds or 6°) of the extra 4.8° is needed for freedom. And so there is only 3.3° available for the snail arm c' , a bit more than half the width of the 14-minute step. In the case of the travelling clock, this means that the tip of the arm can be no wider than about 0.006 inch (0.15 mm).

It is clear that the allowable width in a pocket watch, let alone a wrist watch, is much smaller. But at the same time, the minute-snail arm cannot be too thin, or it may flex or bend. Also, there is little room for error. Striking must be as rapid as practicable, and if it slows down (due to dirt, thickening oil or weakening of the repeater spring) there will almost certainly be insufficient freedom. So the minute-snail freedom mechanism works, but only just. (Hillmann, *La Réparation des Montres Compliquées*, describes the minute snail as having only 14 steps, with the entire zero-minute step removed, so that the 14-minute step is then 12° and the snail arm can be wider.)

In addition to providing detailed instructions on making an hour-snail, Lecoultre also examines how to cut a minute-snail like that in Figure 76.

At the end he states: "To obtain that the [arm] of the minute rack drops onto the fourteenth step, ... the smooth part of each arm of the snail had to be well filed." This obscure statement might refer to cutting back the zero-minute step, which is essential to allow the arm to drop just before the hour, but it is more likely that Lecoultre is commenting on the deep undercutting of the back of the snail arms. Although not obvious, the minute-snail in the eight-day travelling clock (Figures 60 and 72) is also cut back in the same way; this can be seen in Figures 74 and 75. However, this undercutting is pointless, because the snail arm follows the arcs and cannot enter this area. So why do it?

Assuming everything has a purpose, I can only think of one reason. The minute-snail arm may have to be so wide that it is not possible to cut back the minute-snail enough to allow full freedom for the arm to rise when very close to the end of a quarter. Or, as noted above, striking may slow down to the point where there is insufficient freedom. In either case there would be a short period when the snail would press against the arm, which would prevent the canon pinion from rotating. And so undercutting would be necessary to reduce to a minimum the friction of the snail on the arm as it rises, to ensure it will rise and not jam.

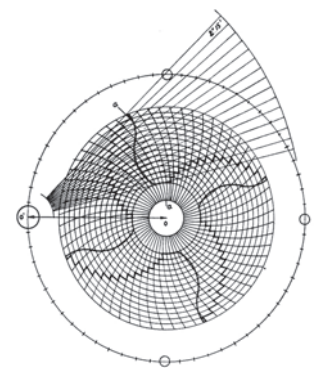

Figure 76

State transitions and hand setting

The behaviour at state transitions of the minute repeaters in Figures 59 and 64 are the same. In both cases it is more complex than in the previous repeaters, because there are two racks and two snails to be considered.

First, when the repeater is activated both the quarter-rack and the minute-rack are free and held against the snails by their drop springs. If the repeater is activated at, say, 11h 29m 59s, when the hour-snail and its jumper-spring are not involved, the hands and the snails will advance to 11h 30m during hour striking. Until this point the jumper α has been holding the freedom piece γ' and the quarter-snail S back, retarded, and the quarter-snail arm c rests safely on the one-quarter step of the snail. At 30m the jumper attempts to snap the freedom piece and the quarter-snail forward, but this is blocked by the minute-snail arm c' and only a small advance, the amount of freedom, is possible. So the quarter-snail arm c continues to rest on the one-quarter step of the snail, and 1 quarter and 14 minutes sound correctly.

If the repeater is activated within a quarter, at 11h 20m 59s, the snails will advance during hour striking, and 1 quarter and 6 minutes will strike.

The same behaviour happens if the repeater is activated a little earlier so that the state transition occurs during quarter striking, remembering that the minute-rack is free until after quarter striking.

Just before the hour, both snail arms are on the lowest step of the snails and cannot advance, ensuring correct striking at this time.

Hand setting has the same problems as in the repeaters described previously.

The minute repeaters I have described use a different freedom mechanism, but the method of turning the hour-snail is the same. Exactly on the hour the star-wheel jumper passes over the tip of a ray of the star-wheel, the star-wheel and hour-snail snap forward, and a ray of the star-wheel pushes on the rear face of the hour-snail driver which pushes the quarter-snail and the minute-snail freedom piece forward ready to strike a full hour.

The Minute Repeater

If the hands are now turned back, the rear face of the hour-snail driver will turn the star-wheel backward against the pressure of its jumper, and the quarter-snail and the minute-snail freedom piece will be held in their advanced position. So, as in the continental quarter repeater, between $57\frac{1}{2}$ minutes and 60 minutes, the repeater will incorrectly sound zero quarters and zero minutes. Striking will be correct only when the hands are turned back to earlier than $57\frac{1}{2}$ minutes.

The same problem occurs at each quarter change. Exactly on the quarter, the minute-snail freedom piece, Figure 64 7', page 35, is snapped forward to ensure correct striking. If the hands are then turned backward, the jumper x will hold the freedom piece out until it slips off the front edge of the freedom piece. Thus if the hands are set back to a minute or two before a quarter, the repeater will incorrectly strike 0 minutes. The quarter-snail is also held forward and so setting the hands back to 14 minutes, for example will cause 2 quarters and 0 minutes to strike.

As with other repeaters, setting the hands of minute repeaters while they are striking is dangerous and must not be done for the same reasons. In addition, in minute repeaters rotation of the canon-pinion is blocked just before the end of each quarter by the minute-counting arm pressing against the minute-snail, and excessive force will damage the snail or the arm.

Chapter 4: The Quarter Repeaters of Stogden and Breguet

Introduction

Not much is known about Matthew Stogden; even his name is variously given as Stacden (Diderot and d'Alambert, *Encyclopedie ou Dictionnaire Raisonne des Sciences, des Arts et des Metiers*, 1765), Stagden (Saunier, *A Treatise on Modern Horology*, 1861), Stogden (Moinet, *Nouveau Traite General, Elementaire, Pratique et Theorique d'Horlogerie*, 1848) and Stockten (Rees, *The Cyclopaedia or Universal Dictionary of Arts, Sciences, and Literature*, 1820). Rees states that he worked for George Graham (and so his repeater dates from the first half of the 18th century) and that his design was used by Graham, Mudge, Dutton, Ellicott and Vulliamy.

Two Stogden repeaters made by John Arnold are illustrated by David Thompson in his book *The History of Watches*, one of which (No. 253) is missing part of the all-or-nothing mechanism and the other (No. ²¹/₆₈) is missing the winding-rack. In addition, this book has a photograph of a repeater made by Thomas Tompion circa 1692. Although quite different in some respects, it is probable that Stogden's design was partly derived from such a repeater.

Wadsworth (*A History of Repeating Watches*, Antiquarian Horology, 1966) says that Stogden's repeater was designed about 1712, but others give dates of 1725 and 1728.

Of these few references, only Rees provides a detailed explanation of the repeater, written by B.L. Vulliamy. But even this contains important errors in the text and the illustrations. However it is much better than Diderot and d'Alambert, who have an incorrect drawing of a quarter-repeater version, and Moinet, who illustrates Breguet's adaptation (which will be discussed later).

Stogden's design, which is normally made as a half-quarter repeater, is worthy of description because it is completely different from the repeaters I have described so far. Although it uses a half-quarter snail and an hour snail, little of the rest of the mechanism is recognisable. However, like all other repeaters, it is based on principles with which we are familiar:

- (a) Like the simplified quarter repeater, there is a *combined hour and half-quarter rack* for striking, and a separate half-quarter counting mechanism.
- (b) The *hammers* and *hammer-pallets* are basically the same as those we have already examined.
- (c) There are *freedom mechanisms* for both snails.

Because of these similarities, much of the mechanism is easy to explain. But things are complicated by some completely different features:

- (d) The hour-snail is *geared* to the canon pinion. It has a *star-wheel*, but the action of the star wheel is quite different.
- (e) The *half-quarter snail* is completely different. In the other repeaters we have examined, the outermost step corresponds to zero quarters or half-quarters and the innermost step to 3 quarters or 7 half-quarters. But in Stogden's repeater the action of the snail has been reversed and the outermost step corresponds to 7 half-quarters. Consequently, the behaviour of the half-quarter counting piece is also reversed because the further it moves, the fewer half-quarters are counted.
- (f) Unlike the simplified quarter repeater, there is an *all-or-nothing mechanism*, and much of what appears strange is related to this mechanism.
- (g) In the simplified repeaters we have examined, the movement of the quarter- or minute-counting piece is limited by a stop and, consequently, the at-rest position of the mechanism is when only some of the quarter- or minute-striking teeth have passed the hammer pallets. In Stogden's repeater the at-rest position is always when *all* the striking teeth have passed the hammer pallets. For this to work, it is essential that there is some mechanism which prevents at least some of these teeth from striking; otherwise the repeater would always strike 7 half-quarters.

The following description explains the different mechanisms in the repeater. Because some pieces perform more than one task, the diagrams highlight the relevant parts. Complete illustrations of the repeater appear at the end of this chapter.

The Quarter Repeaters of Stogden and Breguet

The motion work and snails

Normal motion work consists of the canon pinion, an intermediate-wheel and pinion (usually called the minute wheel) and the hour wheel. To achieve the 12:1 reduction, there is a 3:1 reduction from the canon pinion to the intermediate-wheel, and a 4:1 reduction from the intermediate-wheel's pinion to the hour wheel; the ratios can, of course, be reversed.

However, Stogden's repeater uses a 12:1 reduction from the canon pinion to the intermediate-wheel, and a 1:1 transfer from the intermediate-wheel's "pinion" to the hour wheel.

To do this, the canon pinion, Figure 77 and Figure 78 **10**, has a four-pin lantern-pinion and the *intermediate-wheel*, Figure 78 **R**, has 48 teeth. (A lantern pinion has to be used because it is not possible to make a normal pinion with only four teeth.) The "pinion" on the intermediate-wheel, Figure 78 **u**, is a wheel with the same number of teeth as the hour wheel **v**.

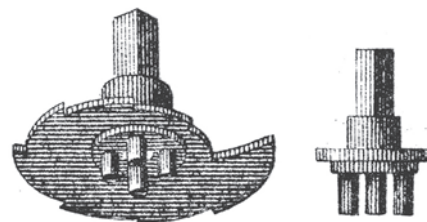

Figure 77

The purpose of this arrangement is to enable the hour-snail **F** and its star wheel **H** to be mounted on the intermediate-wheel **R**.

Figure 79 shows the canon pinion **10** and the snails **S** and **F** when the wheels **u** and **v** have been removed. Figure 78 shows the repeater at rest and Figure 79 is when it is ready to strike. The positions of the snails tell us that in Figure 78 the repeater will strike 5 hours and 6 half-quarters; whereas in Figure 79 the striking will be 6 hours and 7 half-quarters.



Figure 78

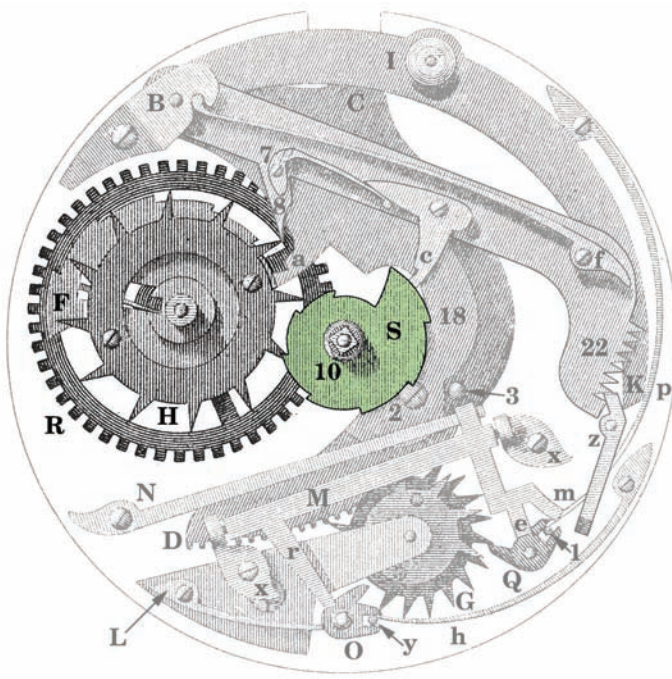

Figure 79

The hour-snail **F** (red) is a normal 12-step snail and requires a freedom mechanism for the change from XII to I hour. For it to function correctly the canon pinion must be placed on the center-wheel arbor and meshed with the intermediate-wheel **R** so that the hour and half-quarter snails are correctly aligned; as we will see later, this was not done correctly when the illustrations were drawn. Also, there must be minimal play in the gearing to avoid inaccurate striking.

As noted above, the half-quarter snail **S** (green) is the reverse of a normal snail. It is clear that, as the canon pinion and snail rotate clockwise, the transition from one half-quarter to the next involves moving to a step which is larger in diameter. So the outer-most step corresponds to 7 half-quarters and the inner-most step to zero half-quarters.

The consequence of this is that a freedom mechanism is required for every transition except that from 7 to zero half-quarters, the reverse of the requirements for a normal snail; so there is no traditional freedom piece. Also, the half-quarter counting and striking mechanism must also act in reverse, because the *least* movement of the half quarter mechanism must result in the *most* strikes.

Striking

There are two superimposed strike racks. The *hour-quarter strike-rack*, Figures 80 and 81 **G**, operates the large-hammer pallet, Figure 81 **Q**. And the *half-quarter strike rack* **G'** operates the small-hammer pallet **O**. The strike racks are screwed onto the *winding-pinion* **t** which is squared onto the repeater-spring arbor.

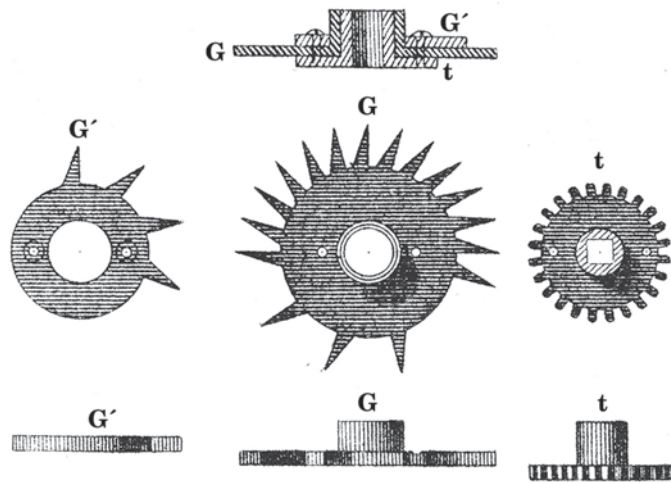

Figure 80



Figure 81

This repeater uses a bell; gongs were not introduced until about 1790. The hours and full quarters are sounded by a loud note, and the half-quarters by a soft note, so that the half-quarters and quarters are sounded by alternating soft and loud notes. For example, at 2h 23m the repeater strikes loud, loud, soft, loud, soft.

The pallets **Q** and **O** are mounted loose on the hammer arbors. So that they mesh with their respective strike racks, the small-hammer pallet **O** is raised higher than the large-hammer pallet **Q**.

Both hammers have a single strike pin mounted between the hammer arbor and head. These pins, **I** and **y**, sit between two arms on the pallets and so the pallets *cannot* move out of mesh with the strike rack teeth. Springs **p** and **h** are the hammer strike springs.

When the repeater is activated, the winding-rack, Figure 78 **D**, rotates the winding-pinion **t** anti-clockwise. The attached strike racks rotate with it, so that all the quarter and half-quarter strike teeth, followed by some hour strike teeth, move past the pallets **Q** and **O**. During striking, the repeater-spring unwinds, and the winding-pinion **t** and the attached racks rotate clockwise, striking the hours followed by the half-quarters and quarters.

The Quarter Repeaters of Stogden and Breguet
All-or-nothing mechanism release

The all-or-nothing mechanism is very complicated and involves 9 different parts. Not only does it prevent incorrect striking, but it also controls striking and ensures that the correct number of quarters and half-quarters are sounded. Because of its complexity, how it releases the repeating will be described first, and how it controls striking and is locked will be covered later.

As in other repeaters, striking is prevented by disengaging the hammer pallets from the strike teeth. But instead of turning the pallets, this is done by *lifting them up*. The hammer arbors and the two hammer strike-pins, Figure 82 **I** and **y**, extend above the pallets **Q** and **O**. When the repeater is at rest, the pallets are raised up so that they are above the level of the strike racks, and while they are held in this position no striking can occur. Releasing the all-or-nothing mechanism drops the pallets down to the level of the racks so that striking can occur, and after striking the all-or-nothing mechanism then lifts the pallets up again.

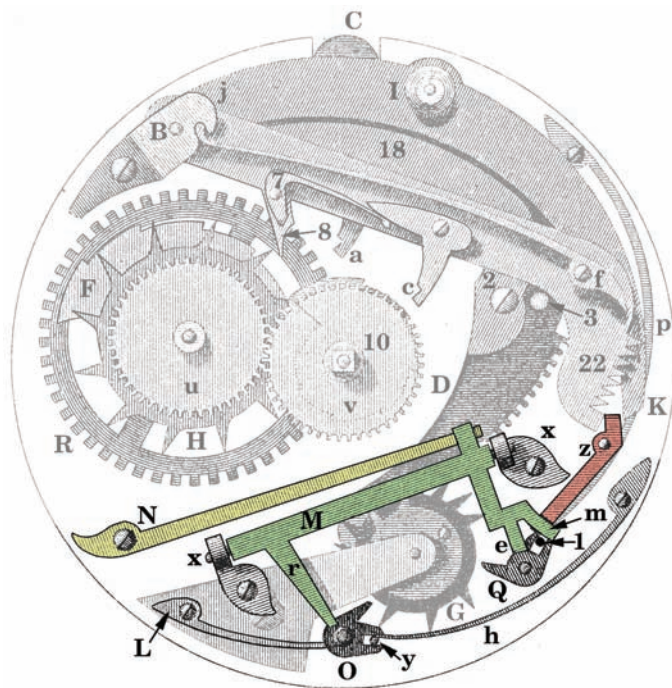

Figure 82

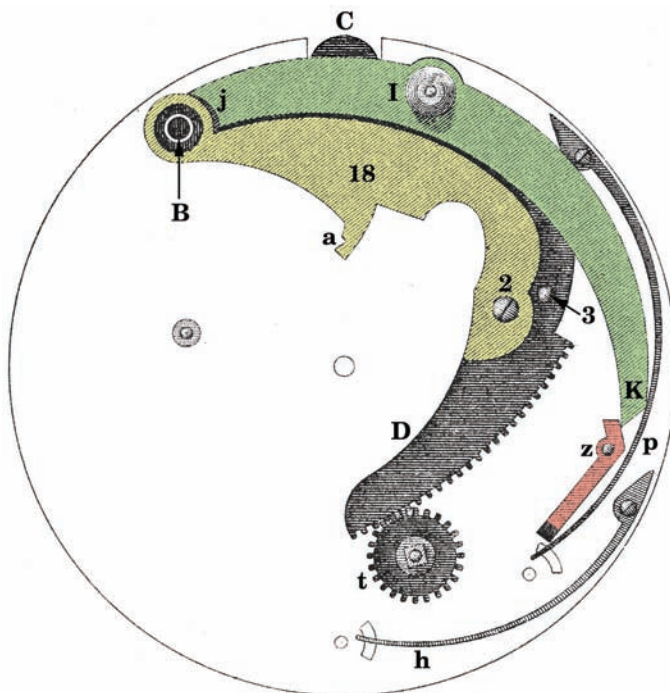

Figure 83

Both pallets are lifted the same amount so that the large-hammer pallet **Q** is then on the same level as the half-quarter rack. To prevent the half-quarter rack tripping the pallet incorrectly, the teeth of the half-quarter rack are shorter than those of the hour-quarter rack and do not reach the pallet **Q**; the pallet **O** is placed closer to the racks so that the half-quarter rack teeth reach it.

Figure 82 **M** is the *all-or-nothing rocker* (green). Arm **r** sits on top of the small-hammer pallet **O** and the spring **L** sits underneath the pallet pushing it upward. Arm **e** of the rocker sits in a slot in the large-hammer pallet **Q**. (Having the rocker arm acting in a slot in the pallet is preferable. However this cannot be done with the small-hammer pallet because the cock which supports the repeater-spring arbor pivot prevents the arm **r** being low enough to act in a slot.) The rocker **M** is supported at both ends by pivots running in the cocks **x**. The rocker spring **N** (yellow) acts to rotate the rocker and force the pallets down.

To prevent the pallets dropping, the *small all-or-nothing piece* **z** (red) fits under arm **m** of the rocker. This piece can rotate around its pivot at **z**. If it rotates anti-clockwise, the rocker is released and its spring **N** forces the pallets to drop. If the small all-or-nothing piece then rotates clockwise the chamfered end will lift up the rocker and the pallets, disengaging them from the strike racks.

The release mechanism, to free the rocker and allow the pallets to drop, is similar in principle to the all-or-nothing release mechanism in the modern quarter repeater, shown in Figures 38 and 41 in Chapter 2 (page 22 on). The *winding-rack* is in two parts. The rack itself, Figure 83 **B-C-D**, pivots at **B** and lies under the *all-or-nothing piece* **j-I-K** (green). The *hour-counting piece* **18** (yellow), with its hour-snail arm **a**, is attached to the winding-rack by the screw **2** and is at the same level as the all-or-nothing piece. The screw **2** has a shoulder and the hour-counting piece is loose. The other end of the hour-counting piece surrounds the winding-rack pivot **B** but does not touch it, so that it has enough play to move the all-or-nothing piece at **j**.

The Quarter Repeaters of Stodden and Breguet

When the push-piece at **C** is depressed and the repeater is activated, the winding-rack rotates clockwise, winding the repeater spring via the winding-pinion **t**, until the hour-snail arm **a** reaches a step of the hour-snail. At this point the rack **B-C-D** can continue to move, causing the hour-counting piece **18** to rotate (relatively) clockwise around its pivot at **2**. With the hour-snail arm **a** resting on the hour-snail, the hour-counting piece is a lever pivoting at **a**, and as the end at **B** drops the end at **B** rises. The movement of the end of the hour-counting piece at **B** causes the all-or-nothing piece to rotate clockwise around its pivot **I**. This movement means the end **K** of the all-or-nothing piece rotates the small all-or-nothing piece **z** (red) anti-clockwise which releases the all-or-nothing rocker and allows the hammer pallets drop.

As this release action only takes place when the winding-rack has been depressed far enough, the mechanism prevents all incorrect striking. Note that *all* the repeaters we have looked at use the position of the hour-snail arm to determine when to unlock the all-or-nothing mechanism.

Hour and half-quarter counting

During winding, *all* the quarter and half-quarter striking teeth pass the hammer pallets, just as they do with the simplified quarter repeater. And so there must be a mechanism to ensure only the right number of quarters and half-quarters are struck. This is achieved by the half-quarter counting piece and the small all-or-nothing piece.

When the repeater is at rest, Figure 84, the *half-quarter-counting piece B-22* (green) is held away from the half-quarter snail **S** (under the hour-wheel **v**) by pin **3** mounted on the winding-rack.

In this position, the end of the half-quarter-counting piece, the *small all-or-nothing piece lock face m'*, locks the small all-or-nothing piece **z** (red) rotated clockwise, and so the pallets are raised away from the strike racks.

As soon as pressure is applied to the push-piece, pin **3** moves away from the half-quarter-counting piece, which drops under the pressure of its drop spring **f** until its half-quarter-snail arm **c** reaches the half-quarter snail under **v**. The small all-or-nothing piece **z** is held in place by the friction between it and the all-or-nothing rocker **m**, and the teeth at **22** move past the end of the small all-or-nothing piece.

If the push piece is not depressed far enough to release the all-or-nothing mechanism, the winding-rack will return to its at-rest position without striking, and pin **3** will raise the half-quarter-counting piece to its original position.

In detail, the activation of the mechanism and counting is:

- (a) The winding rack **D** rotates clockwise until the half-quarter-snail arm **c** reaches the half-quarter snail **S**. Pin **3** on the winding rack **D** is touching the half-quarter-counting piece **22**, as in Figure 85.

At this point the end of the small all-or-nothing piece **z** is opposite the appropriate gap between the teeth of the half-quarter-counting piece **22**. Figure 85 shows the position at 6 hours and 7 half-quarters, and Figure 85 shows the position at 6h 30m when the half-quarter-snail arm lands on the 4th half-quarter step; the numbers indicate the snail step for each position of the small all-or-nothing piece.

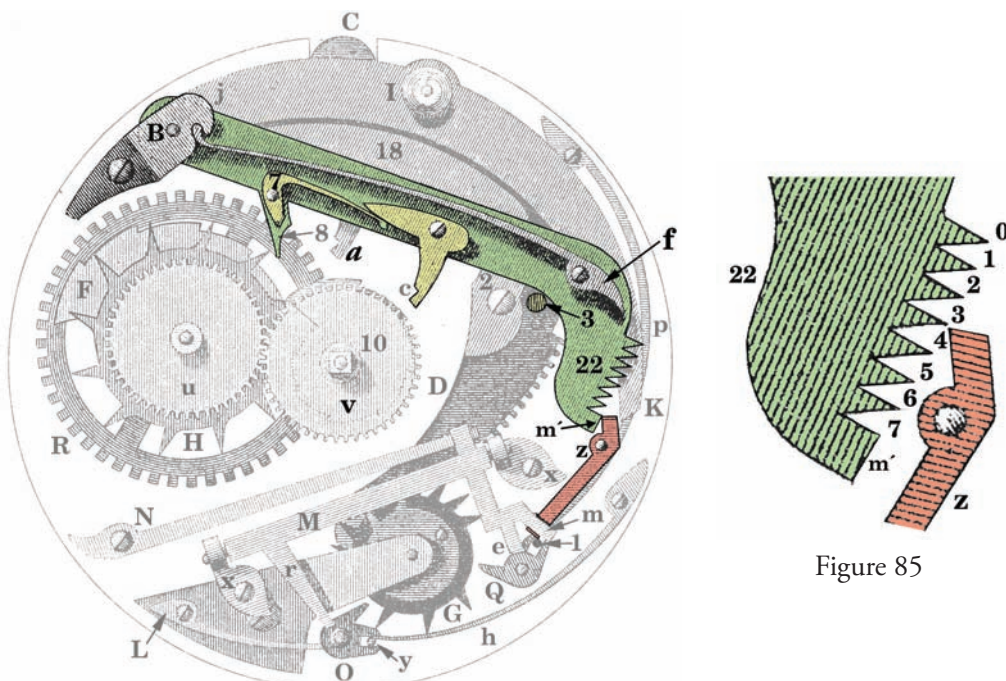

Figure 84

Figure 85

The Quarter Repeaters of Stogden and Breguet

The two strike racks have rotated so that the *number of half-quarters which are not to strike* have passed the pallets **O** and **Q**. In Figure 86 no half-quarter teeth have passed the pallets. In Figure 85 4 half-quarters are to strike and so 3 teeth have passed the pallets, two half-quarter strike teeth and one quarter strike tooth, so that **z** is above the 4th gap. (If n half-quarters are to strike then the end of the all-or-nothing piece is opposite tooth n of the half-quarter-counting piece and $7-n$ strike teeth have passed the pallets. These teeth are, alternately, half-quarter strike teeth acting on pallet **O** and quarter strike teeth acting on pallet **Q**.) They are cut so that they correspond exactly to the movement of the half-quarter-snail arm **c** from one step to the next on the half-quarter snail **S**.

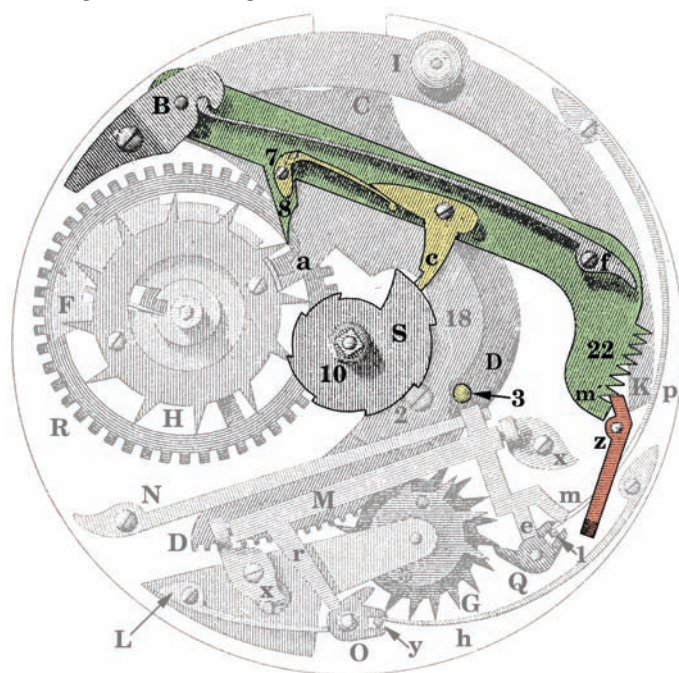

Figure 86

- (b) The winding rack **D** continues to rotate clockwise until the hour-snail arm **a** is just outside the hour-snail, and all of the half-quarter and quarter teeth on the strike racks have passed the pallets **O** and **Q**. The total movement of the winding rack is sufficient for the half-quarter-counting piece to drop onto the innermost half-quarter snail step. At this point, the distance between the winding-rack's pin **3** and the half-quarter-counting piece **22** depends on which step of the half-quarter snail **S** the half-quarter-snail arm **c** comes to rest; it is greatest for the outermost step and least for the innermost step.
- (c) The winding rack **D** continues to rotate clockwise until the hour-snail arm **a** rests on a step of the hour-snail and the correct number of hour strike teeth have passed the pallet **Q**. Pin **3** has moved a further distance from the half-quarter-counting piece, equivalent to the number of hours to be struck.
- (d) If the push piece is depressed far enough to release the all-or-nothing mechanism, Figure 86, then the end of the small all-or-nothing piece **z** is moved so that it fits into the gap between two of the teeth on the half-quarter-counting piece **22** corresponding to the number of half-quarter and quarter teeth on the strike racks to strike.

Striking and locking the all-or-nothing mechanism

The sequence of events during striking is the reverse:

- (a) The repeater spring rotates winding-pinion **t** and the winding-rack **D** anti-clockwise, and the correct number of hours strike on the large hammer. Now the hour-snail arm **a** is again just outside the hour-snail.
- (b) The repeater spring continues to rotate the winding-pinion and the winding-rack anti-clockwise, striking half-quarters on the small hammer and full quarters on the large hammer alternately. The distance moved by the winding-rack, before pin **3** meets the half-quarter-counting piece, must be *exactly the same* as the distance the strike racks **G** and **G'** need to rotate to strike the correct number of quarters and half-quarters.
- (c) At this point, pin **3** on the winding-rack meets the half-quarter-counting piece **22**. As the winding-rack continues to rotate anti-clockwise, pin **3** moves the half-quarter-counting piece **22** and the tooth or the locking face beside the small all-or-nothing piece **z** rotates it clockwise, raising the pallets so that no further striking takes place. *All striking* must take place before pin **3** meets the half-quarter-counting piece and starts moving it.
- (d) The repeater-spring continues to unwind, raising the winding-rack and the half-quarter-counting piece together they return to the at-rest position and the small all-or-nothing lock face **m'** locks the small all-or-nothing piece.

The small all-or-nothing piece lock face **m'** is essential. The shapes of the half-quarter counting teeth **22** and the small all-or-nothing piece **z** are such that if the small all-or-nothing piece accidentally moves into the space between two teeth then the push piece and the winding-rack cannot be depressed further. If this happened during activation the snail arms would not reach the snails, and when pressure is released some incorrect striking will occur and the small all-or-nothing

The Quarter Repeaters of Stogden and Breguet

piece would return to its correct position. Without the lock face, the small all-or-nothing piece could drop below tooth 7 of the half-quarter counting teeth, and then the push piece and the winding-rack could *never* be depressed and the small all-or-nothing piece would remain in that position. The repeater would be permanently jammed and could only be freed by removing the dial and repositioning the small all-or-nothing piece.

Half-quarter-snail freedom and accuracy

Vulliamy's description of Stogden's repeater (in Rees, *The Cyclopaedia or Universal Dictionary of Arts, Sciences, and Literature*) is noteworthy because he is the only writer to explicitly mention the need for freedom. I suspect this is because Vulliamy was a watchmaker who actually made repeaters; I doubt if any of the other authors cited in the previous chapters, except Crespe, made repeaters. To quote Vulliamy, regarding the half-quarter snail freedom mechanism (see Figures 85 and 86):

“The arm *c* (yellow) is made a separate piece from and fixed to the quarter-rack **22** ... and is kept in place by the spring **7**: the reason of this piece being thus made, is to *prevent the possibility ... of the repeating-work stopping the watch*, by the arm *c* holding back the quarter-snail, during the striking of the hours” (my italics).

Thus, if the repeater is activated a few seconds before the end of every half-quarter, except the 7th half-quarter, then as the canon pinion rotates the half-quarter-snail arm *c* will be pressed against the edge of the next step, and if the arm was fixed the canon pinion could not rotate. However, the *half-quarter freedom spring 7* allows the canon pinion to push the snail arm aside. (Although not shown in the illustrations, and not mentioned by Vulliamy, there must be a stop against which the half-quarter-snail arm *c* rests, to hold the arm in the correct position.) This small movement of the half-quarter-snail arm will not affect counting or striking because the half-quarter-counting piece **22** is effectively fixed in place by the small all-or-nothing piece **z**.

Note that, as shown in Figure 86, normally it is the *leading* edge of the half-quarter-snail arm *c* that determines the half-quarter points, but it is the *trailing* edge for the change from 7 to 0 half-quarters; so the 7-quarter step must be made narrower, and the 0-quarter step wider, by the width of the half-quarter-snail arm.

This half-quarter snail freedom mechanism is that which I proposed at the start of Chapter 2 and rejected because of the lack of control over accuracy (page 21). There are two possible problems with Stogden's repeater:

- (a) Just before the hour, a very small inaccuracy in the half-quarter-snail arm and its action could cause the arm to drop into the zero half-quarter step instead of sitting on the 7 half-quarter step and incorrect striking might occur; in this case 2 hours exactly might sound instead of 2 hours and 7 half-quarters.
- (b) Just on and after the hour, a small amount of dirt between the half-quarter-snail arm *c* and its stop could cause the arm to land on the 7 half-quarter step of the snail instead of dropping into the 0 half-quarter step; for example, the repeater might sound 2 hours and 7 half-quarters instead of 2 hours exactly.

These problems are of little importance at other half-quarter changes, because then they will only show as slight discrepancies between the minute-hand and striking.

Thus wear and slight rounding or damage to either the edge of the snail steps or the trailing edge of the half-quarter-snail arm could produce unavoidable errors, and this method of allowing freedom is fundamentally unsatisfactory. However, we will see that half-quarter counting is intimately related to hour counting and actually these errors in striking cannot occur.

Hour-snail freedom and accuracy

Hour-snail freedom and accuracy is equally important because, unlike the repeaters in previous chapters, the hour snail is continuously driven by the canon pinion.

Activating the repeater just before 1 o'clock can mean the hour-snail arm *a* prevents the hour-snail from rotating (anti-clockwise) and causes the canon pinion to slip or the going train to stop. And so a freedom mechanism is necessary.

Also, just before the hour the hour-snail arm could drop into the step for the next hour and, for example, 6 hours 7 quarters could strike instead of 5 hours 7 quarters. Or, just after the hour the arm could land on the end of the step for the previous hour when the repeater would strike 5 hours instead of 6 hours.

In addition, the hour-snail arm *a* can be pressed on the hour snail with considerable force. If the edge of the arm meets the edge of a step of the hour snail, then damage and errors in striking are likely.

The Quarter Repeaters of Stogden and Breguet

To overcome these problems, Stogden's repeater uses the reverse of the half-quarter freedom mechanism. That is, instead of a fixed snail and spring loaded snail arm, there is a spring loaded snail and fixed snail arm. The hour-snail and its star wheel are mounted *loose* on the intermediate wheel. The hour-snail, Figure 87 *F*, and the star wheel *H* are screwed together. They sit loose on the hub of the intermediate wheel *R*. The intermediate "pinion" *u* fits friction tight on the intermediate wheel arbor. It has a large hub which fits inside the star wheel and holds the four wheels together.

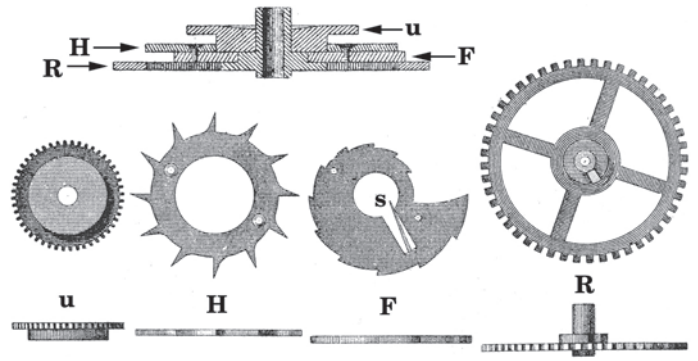

Figure 87

Because the hour-snail and star wheel *must* rotate with the intermediate wheel, the hour-snail has an integral straight spring *s*, the *hour freedom spring*, which sits in a slot in the hub of the intermediate wheel; as the intermediate wheel rotates anti-clockwise the hour freedom spring *s* forces the hour-snail and star wheel to rotate with it. According to the illustrations, *s* is in a slot in the hour-snail that is wide enough to allow an independent rotation of the hour-snail and star wheel of about 15°.

How the spring works is obscure because the illustrations provided by Rees have errors. The hour-snail and star wheel rotate with the intermediate wheel, which is driven by the canon pinion. When the repeater is activated in the 7th half-quarter near the hour, Figure 88, the *star-wheel arm* Figure 88 *8* (green), mounted on the quarter-counting piece *22*, is held away from the rays of the star wheel *H*. This is because the half-quarter-snail does not allow the quarter-counting piece to drop far enough for the star-wheel arm to drop below the tip of the ray. On the hour, when the half-quarter-snail arm *c* drops into the zero half-quarter step, the star-wheel arm *8* will press against the back of a star-wheel ray. At this time the star-wheel has rotated anti-clockwise about 2° (relative to Figure 88) and the ray is just behind the star-wheel arm.

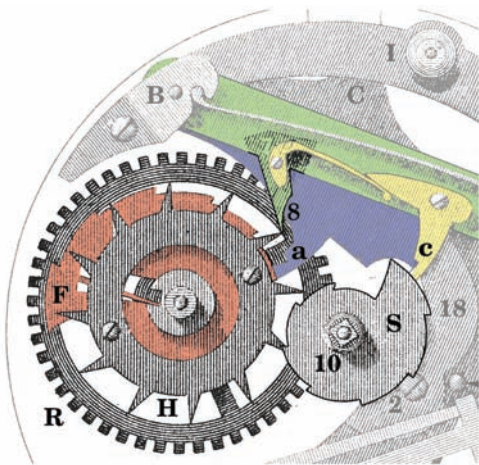

Figure 88

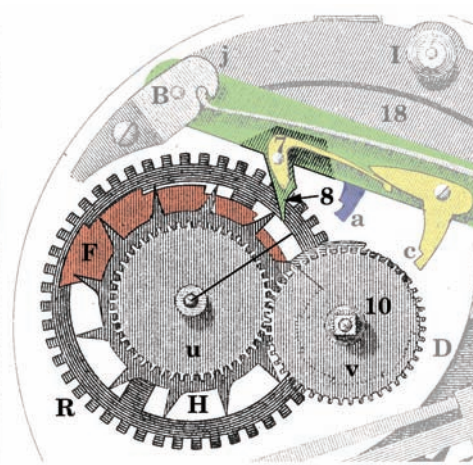

Figure 89

Before looking at the consequences of this, what happens at other times? Figure 89 is wrong. Most likely the artist used by Rees drew Figure 99 (at the end of this chapter, page 54), and from which Figure 88 is derived, while the repeater was being taken apart. Then it was re-assembled incorrectly and the artist drew Figure 98, from which Figure 89 is derived. The problem is that the canon pinion and half-quarter-snail were put on out of synchronisation with the hour-snail assembly, Figure 87, and so the snails are out of alignment. The error is about two teeth of the intermediate wheel *R* (15°) and the black line on Figure 89 shows the correct position of the star-wheel rays.

Figure 89 is the position at about 15 minutes before the hour. If one ray is on the black line, the next ray is 36° away anti-clockwise from it and the star-wheel arm *8* will drop into the gap between the two rays and do nothing. This appears to happen during all the half-quarters 1 to 6. And, as noted above, during the 7th half-quarter the star-wheel arm is held outside the rays and does nothing. It is only during the 0 half-quarter that the star-wheel arm can act on a ray.

We can now explain how the star-wheel and the star-wheel arm work. Just before the hour changes, the hour-snail arm *a*, which is quite narrow, lands fully on the end of the hour-snail step for the current hour, and it is the *leading* edge of hour-snail arm *a* (that nearest the next hour step) which determines the hour points. This means that throughout an hour the arm always falls fully onto a step; whereas if the trailing edge had been used, then at the end of each hour the arm

The Quarter Repeaters of Stogden and Breguet

would land precariously on the end of a step. However, unless there is some additional mechanism this means the width of the arm will cause one too few hours to strike until the trailing edge of the arm drops into the step for the next hour.

Just after the hour, Figures 90a and 90b, the half-quarter-snail arm *c* will drop into the deepest, zero half-quarter step and the star-wheel arm *8* will press down *behind* the tip of a star-wheel ray; this happens before the hour-snail arm *a* reaches the hour-snail. The star-wheel arm forces the star-wheel and hour-snail to *advance anti-clockwise* about 18°, bending the hour freedom spring *s* so that it presses against the other side of the slot in the hour-snail, and the hour-snail arm *a* drops safely onto the beginning of the step for the next hour; without this advance it would still land on the step for the previous hour. Note that the hour-snail arm *a* is only about 10° wide and there is ample freedom. (Vulliamy confuses the reader by calling the star-wheel *H* the *retrograding ratchet*. It does not act like a normal star wheel, and it could be called the *advancing ratchet* as that is its action. But his description is correct; he says that *after* the hour the snail is advanced to prevent the snail arm *a* being stopped by the preceding step, causing the watch to repeat one hour less than it shows.) During striking the quarter-counting piece and its star-wheel arm rise, freeing the star-wheel ray and the star-wheel and hour snail move back to their normal positions under the pressure of the hour freedom spring.

As the half-quarter-snail and the intermediate-wheel *R* rotate, the gap between the star-wheel arm *8* and the star-wheel ray slowly increases and, if the repeater is activated, the advance will slowly decrease. Also, in each successive half-quarter the half-quarter-snail arm *c* drops a smaller distance, and so the star-wheel arm has a correspondingly smaller effect. At the start of the second half-quarter the advance is about 12°, and at the start of the third, Figures 90c and 90d, it is about 8°. Again the hour-snail arm will drop safely onto the step for the current hour. The size and angle of the star-wheel arm means that it acts for about 22½ minutes.

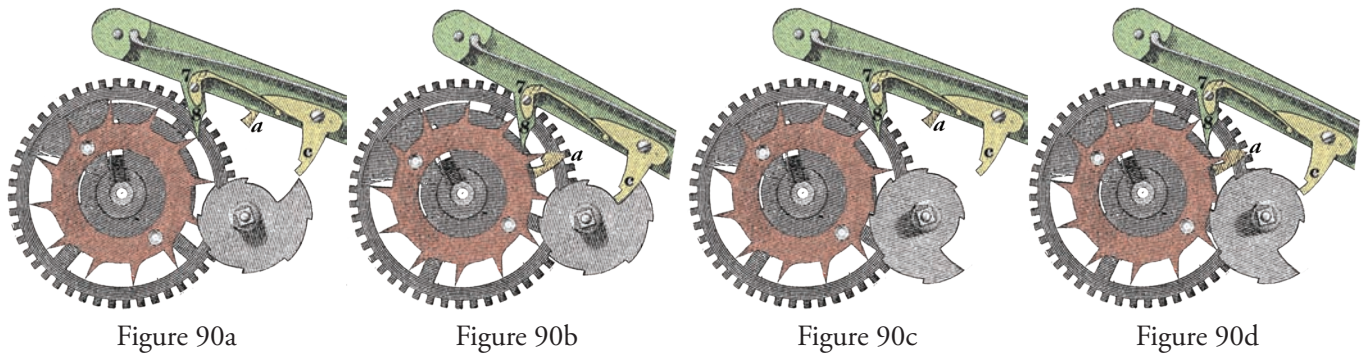

This applies to all hour changes, including from XII to I. But the XII to I change requires freedom between the leading edge of the hour-snail arm and the side of the I hour step to avoid stopping the canon pinion. So the XII hour step is made wider, and the I hour step narrower to provide this freedom, while the advance of the hour-snail on the hour ensures correct striking.

As I have noted, the advance is achieved by the integral spring *s* and the slot in the hub of the intermediate wheel. Usually, Figure 88, the spring *s* holds the hour-snail in its normal position relative to the intermediate wheel *R* and hence relative to the quarter-snail. But in Figure 88 the slot is so wide that the hour-snail and star-wheel can flop backwards and forwards, and this freedom is unacceptable.

The only sensible arrangement is shown in Figure 91. Here the hour freedom spring *s* fits diagonally across a narrow slot on the intermediate-wheel hub and holds the hour-snail so that it is in its normal position. The narrower slot still enables the hour-snail to advance sufficiently.

Although this mechanism is satisfactory, it seems to have one fault. If the repeater is activated exactly on the hour, it is possible for the star-wheel arm *8* to butt on the end of a star-wheel ray, preventing the half-quarter counting piece and the half-quarter snail arm *c* from dropping into the zero quarter step, and leaving the hour-snail retarded. So at, for example, 6 hours the repeater will incorrectly strike 5 hours and 7 half-quarters. However this is easily avoided by ensuring the position of the star-wheel will guarantee butting does not take place. To do this, the star-wheel can be fixed to the hour snail so that it is advanced a small amount relative to the hour-snail, and then the star-wheel arm always drops onto the back of a ray on the hour. This cannot affect striking before the hour because the half-quarter-snail arm *c* holds the star-wheel arm away from the star-wheel.

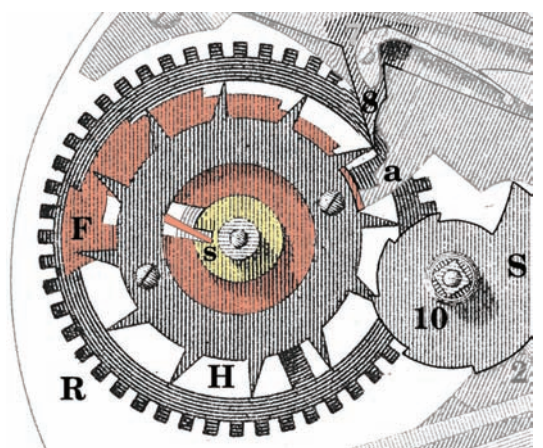

Figure 91

The Quarter Repeaters of Stogden and Breguet

This mechanism also prevents the serious errors in striking that might occur from the quarter counting mechanism.

- Just before the hour, a small inaccuracy in the half-quarter-snail arm *c* could cause the snail arm to drop into the zero half-quarter step instead of sitting on the 7 half-quarter step. But in this case, the star-wheel arm *8* will advance the hour-snail and, for example, 3 hours exactly will strike at 2h 59m 55s.
- Just on and after the hour, a small inaccuracy in the half-quarter-snail arm or dirt between it and its stop (not shown in the illustrations) could cause the arm to land on the 7 half-quarter step of the snail instead of dropping into the 0 half-quarter step. But in this case, the star-wheel arm *8* will be held away from the star-wheel and the hour-snail will not advance; so 2 hours and 7 half-quarters will strike at 3 hours exactly.

In both cases there will only be a small discrepancy between the minute-hand and the striking. Although this is unsatisfactory, it would be acceptable in the context of the inaccurate watches made at the time.

Strike timing

Strike timing is similar to that of the simplified quarter-repeater (see Figures 45 to 48 of Chapter 2, page 25 on).

Figure 92 shows the repeater at rest. It is always in this position after striking, with all the hour, quarter and half-quarter strike teeth past the pallets.

Figure 93 shows the position when the repeater is activated at 4 hours 23 minutes. The repeater-spring arbor and the strike racks have rotated anti-clockwise until the winding-rack's hour-snail arm has reached the hour-snail. When striking takes place, with the arbor turning clockwise, 4 hours strike immediately followed by 3 strikes for 3 half-quarters. At this point the small all-or-nothing piece *z* raises the hammer pallets and the repeater-spring arbor continues rotating silently to its rest position without further striking.

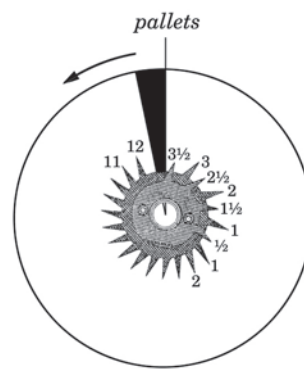

Figure 92

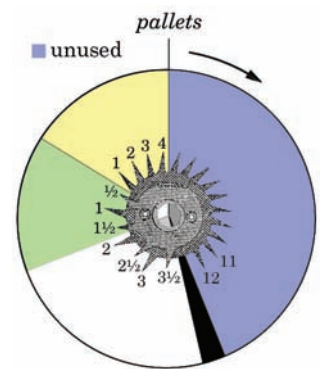

Figure 93

Although very unlikely, it may be possible to produce an error in striking. For example (see Figure 85, page 45), after striking 4 hours 22½ minutes, pin *3* on the winding rack meets the half-quarter counting piece and the small all-or-nothing piece *z* is rotated clockwise as it runs over the counting teeth *22*. This raises the all-or-nothing rocker and consequently raises the pallets and preventing further striking, creating the period of silence shown in Figure 93. When the repeater reaches its at-rest position the small all-or-nothing piece is locked in place by the raised end of the counting teeth and striking is impossible until the repeater is activated again. However, after striking the half-quarters there is a period during which the small all-or-nothing piece passes over the counting teeth (as in Figure 85) and a sudden jolt could cause it to move anti-clockwise and drop into a space between the teeth. If this happened the hammer pallets would drop and there would be a single spurious strike, after which the small all-or-nothing piece would again be moved into its correct position.

Hand setting

Unlike all the other repeaters I have described, because both snails are continuously rotated by the motion-work and there is no freedom piece, the hands of a Stogden repeater can be set backward without any difficulty. The only possible problem is when the lantern pinion on the canon pinion, Figure 77 (page 42), has some play between the teeth of the intermediate wheel, Figure 79 *R*. Then it is possible for the wrong hour to strike if the hands are turned back to a few seconds before the hour. Ideally there should be no play at all between these two pieces.

Setting the hands when the repeater has been activated, is also different from the other repeaters described previously. Setting the hands forward from, for example, 14 minutes will cause the half-quarter snail arm, Figure 85 *c*, to rotate and lift onto the next step of the snail. But what happens depends on the relative strengths of the half-quarter freedom spring *7* and the counting-piece drop spring *f* (see Figure 84, page 45). If the former is too strong the counting-piece will be raised, the small all-or-nothing piece will rotate clockwise and striking will cease prematurely.

Setting the hands back from just after the hour will cause the canon-pinion and the half-quarter snail to be blocked by the half-quarter snail arm, resulting in damage.

And, as with other repeaters, attempting to set the hands forward from 12 hours 59 minutes is not possible because the canon-pinion is blocked by the hour-snail arm.

Breguet's half-quarter repeater

Breguet made a considerable number of watches with repeaters, but information about them is very limited. David Salomons *Breguet 1747-1823* has a few photographs, but they are small, black and white, and unsatisfactory. The many photographs in George Daniels *The Art of Breguet* are, with a few exceptions, the same or poorer, and it is impossible to interpret them satisfactorily. And Emmanuel Breguet *Breguet, Watchmakers since 1775* has no photographs of repeater mechanisms at all. The only book with good, useful photographs is the Antiquorum auction catalogue *The Art of Breguet* which has more than 20 illustrations of repeater mechanisms.

Emmanuel Breguet states that “Abraham-Louis Breguet was the father of all modern repeating watches”. The Antiquorum catalogue is a little more circumspect and says that one of Breguet’s innovations (as opposed to inventions) in 1787 was a “new design of repeating work for 10 minute, ¼ hour, ½ ¼ hour and minute repeating”. However, neither claim is justified. A careful examination of the Antiquorum photographs of repeater mechanisms shows that, with one exception, his repeaters were based on older designs, which died out, and they have little or no relationship with modern repeaters.

There are two useful technical descriptions.

Lecoultre, in *A Guide to Complicated Watches*, describes a half-quarter repeater made by Breguet at the beginning of the 19th century. He prefaces his description by stating that “the mechanism is wholly different from [those] described in the preceding pages”. On first reading, Lecoultre’s description is obscure, until we realise that Breguet’s half-quarter repeater is simply an adaptation of Stogden’s repeater.

George Daniels, in *The Art of Breguet*, also describes this repeater and an earlier variant of it, and provides several line drawings of both. Again the description is obscure, because Daniels makes no reference to Stogden and he describes parts without giving an adequate explanation of their function.

The link with Stogden is emphasised by Breguet’s watch number 128^{5/8} made in 1785 and illustrated by Daniels. Although a minute repeater (and discussion of it is deferred to Chapter 6) it is, as Daniels notes “almost an exact copy of the mid-eighteenth century work of Thomas Mudge ... and must undoubtedly have been made in England.” One Mudge repeater is illustrated in *The History of Watches* by David Thompson, but it is significantly different from the Breguet repeater. However, Breguet’s watch is almost identical to a repeater made by John Arnold. Both the watches by Mudge and Arnold are clearly derived from Stogden’s design.

The influence of Stogden is clear. Of 20 illustrated repeater mechanisms in the Antiquorum catalogue *The Art of Breguet*, thirteen are based on Stogden’s design, five are standard quarter repeaters, as described in Chapters 1 and 2, one is a “modern” minute repeater, as described in Chapter 3, and one is a “strange” quarter repeater. The “modern” minute repeater is lot 49 and was made in 1820. Another illustration of one appears in Daniels *The Art of Breguet*, illustration 34.

Many repeaters are idiosyncratic, illustrating Breguet’s tendency to make every watch unique. The “strange” repeater, lot 56 in the catalogue, is an interesting example and it is reproduced in Figure 94.

The most important point is that the quarter strike-rack **a**, with two sets of teeth, is the same size and shape as the hour strike-rack beneath it. Both are mounted on the repeater-spring arbor, but the quarter strike-rack is loose. There is a standard all-or-nothing piece **b** which locks it in place at **c**. The quarter-rack quarter-snail arm **d** is not part of the rack, but is part of the drop spring **f**! When the all-or-nothing piece releases the quarter-rack, the snail arm drops onto the snail and a pin on the quarter-rack, that enters the slot on the end of the snail arm rotates the rack the correct number of teeth. So this is just an ordinary quarter repeater with no special features other than the idiosyncratic shape and arrangement of the quarter-rack. It is unusual and “innovative”, but it is simply a tour-de-force which displays the watchmaker’s abilities.



Figure 94

The Quarter Repeaters of Stogden and Breguet

Also, this repeater has been ascribed to Lepine by Moinet, *Nouveau traite général, élémentaire, pratique et théorique d'horlogerie* (volume 1 pages 217-218 and plate X), in which case Breguet simply copied the design.

Thus, of these 20 watches, only one, the “modern” minute repeater, has a design which was used extensively after Breguet’s death and is used even today. But whether Breguet invented or copied this design is not known to me. And 13 watches use designs based on a 1720 idea which has since faded into history.

It seems very likely that Breguet was introduced to Stogden’s design through John Arnold or his son John Roger Arnold, Arnold having made several Stogden repeaters which pre-date Breguet. Breguet then produced his own idiosyncratic and clever adaptation of it.

Figure 95 shows the mechanism at rest. This repeater uses a single hammer and hammer-pallet striking on the case or a gong. It strikes single notes for the hours, followed by double notes for the whole quarters and, if necessary, a single note for the following half-quarter. The most obvious difference from Stogden’s repeater is that the hour-snail *F* (light blue) is not geared to the canon pinion. Instead it is loose and held in place by the star-wheel *H* and jumper *b*. Also, the hour-snail covers twenty-four hours, having 2 twelve-hour snails. Consequently each step is only 15° instead of 30° wide and so only 7½° of freedom are needed for the star-wheel to advance the snail after the jumper has reached the tip of a ray.

Because there is only one hammer and one pallet, an all-or-nothing rocker is not needed. Instead, this repeater has two superimposed springs *r* (yellow) and *e* (red) which control the vertical position of the hammer-pallet *Q*. The bottom spring *e* is stronger, and when the repeater is at rest the pallet is held down and out of mesh with the strike-rack *G* by the small all-or-nothing piece *z*. The spring *r* ensures that the pallet is held down. The large all-or-nothing piece *I-j-K* (green) pivots under a shoulder screw at *I*, and the hour-snail *F* and star-wheel *H* are attached to it at *j*. Its arm *j-K* passes under the winding rack *C-a-D* (dark blue) and rests against the tooth *z'* attached to the small all-or-nothing piece *z*. When the repeater is activated by the slide, the pressure of the winding-rack hour-snail arm *a* on the hour-snail rotates the large all-or-nothing piece anti-clockwise so that the arm *j-K* rotates the small all-or-nothing piece *z* clockwise, releasing the spring *e* which raises the hammer-pallet *Q* to the level of the strike-rack *G*.

The half-quarter counting piece *B-22-c* (dark grey) pivots at *B* and drops under the pressure of its drop spring *f*. Instead of using a pin mounted on the winding-rack to control the movement of the half-quarter counting piece, the foot *3* of the drop spring serves this purpose. It uses the same form of small all-or-nothing lock face *m'* as Stogden’s repeater.

Activation, release of the all-or-nothing mechanism, striking and locking the all-or-nothing mechanism are exactly the same as in Stogden’s repeater. One difference is the arrangement of the quarter and half-quarter strike teeth on the strike-rack *G*, a consequence of having only one hammer. Instead of the teeth being equidistant, the first, third and fifth half-quarter teeth (counting from the hour strike teeth) are moved closer to the following teeth to create a double strike. When a half-quarter is sounded only the first tooth of a pair is used. For example, at 25 minutes the first three teeth strike a double note, a pause and a single note before the small all-or-nothing piece drops the hammer pallet to prevent further striking.

The accuracy and freedom mechanisms, although different, also derive in part from Stogden’s design. The half-quarter snail *S* is loose and is kept in position by an integral weak spring *s*, in the same manner as the hour-snail in Stogden’s repeater. The hour-snail is driven by an hour-snail driver *8* mounted on the underside of the half-quarter snail; see Figure 96. As will be shown in Chapter 6, John Arnold also used a loose quarter snail with an integral spring, and it is possible Breguet got his basic idea from an Arnold repeater.

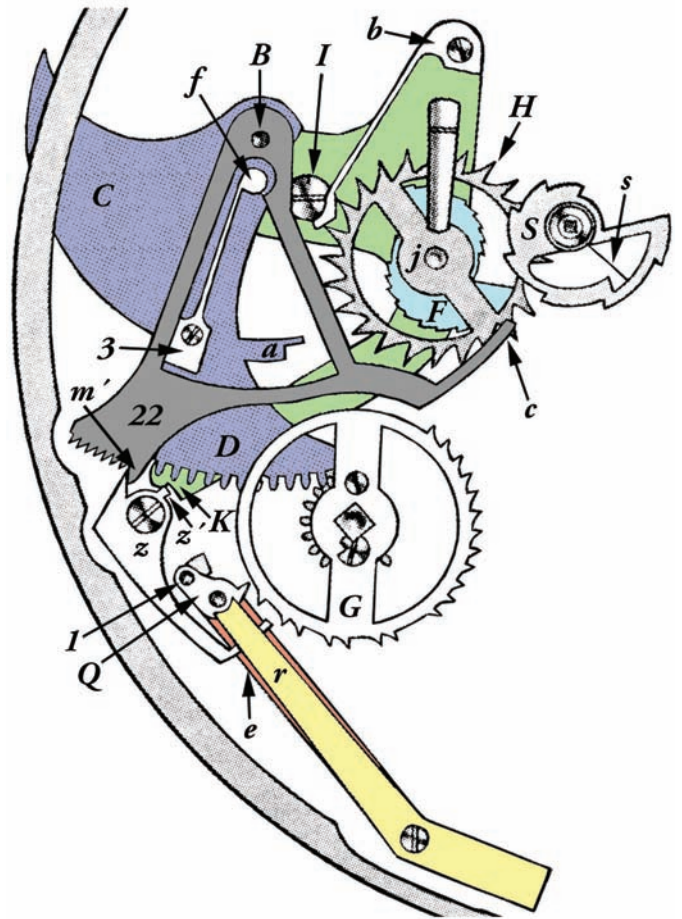

Figure 95

The Quarter Repeaters of Stogden and Breguet

Figure 96 is an *underneath* view from a quarter-repeater variant of Breguet's mechanism; from this perspective the quarter-snail rotates anti-clockwise and the hour-snail clockwise.

The movement of the snail *S* is limited by pin *11* (green), mounted on the snail and acting in a slot in a collet rigidly attached to the canon pinion. The spring *s* acts on pin *11'* (red) mounted on the collet, and it is this pin that drives the snail through the spring. (Alternatively, *s* can act in a slot in the collet.)

This spring *s* serves the same function as the spring *7* in Stogden's repeater. If the repeater is activated just before the end of a quarter or half-quarter, and the arm *c* blocks the advance of the snail and canon pinion, the canon pinion will continue to rotate while the spring *s* bends and the snail is held stationary.

When the hour changes, the hour and quarter snail freedom and accuracy is basically the same as in other repeaters using star-wheels. Figure 97 shows the position just before the hour.

The hour-snail driver *8* (blue) has rotated the hour-snail and star-wheel $7\frac{1}{2}^\circ$ until the jumper *b* is at the tip of a ray, and exactly on the hour the hour-snail and star-wheel jump forward to the next hour.

The quarter or half-quarter snail behaviour is a little more complicated. As usual, it is the leading edge of the snail arm *c* that determines the change of half-quarters. And so the 3 quarter or 7 half-quarter step of the snail must be cut back by the width of the arm *c* so that the arm can land on the innermost zero step exactly on the hour. The spring *s* is weaker than the jumper spring *b*. So, from about 5 minutes before the hour, when the hour-snail driver *8* starts pushing the star-wheel against the pressure of the jumper *b*, the snail *S* is held stationary and so is *retarded* relative to the canon pinion. This ensures that the arm *c* will always land fully onto the snail before the hour.

As the snail is stationary while the canon pinion continues rotating, the rear edge of the slot in the collet catches up to pin *11* and rotates the snail *S*, with the spring *s* tensioned, to the position in Figure 97. On the hour, when the hour-snail and star-wheel jump forward, the hour-snail driver *8* is no longer impeded by the star-wheel and so the spring *s* causes the snail *S* to jump forward and pin *11* returns to the other end of the slot, as in Figure 96. In this position the trailing edge of the snail arm *c* is in front of the end of the 3rd quarter (or 7th half-quarter) step and drops correctly onto the 0 quarter or half-quarter step.

In *The Origins of Self-Winding Watches* (second edition, page 372) I note that every Breguet self-winding watch (for which there are suitable photographs) is unique, and the differences are arbitrary and are not "improvements". My opinion is that Breguet made every watch different as an aid to selling them, because very wealthy people would prefer to own a watch that no one else could possess. I don't know if this applies to Breguet's repeaters, because the mechanism is hidden under the dial and not able to be displayed, so perhaps his designs are the result of curiosity rather than advertising.

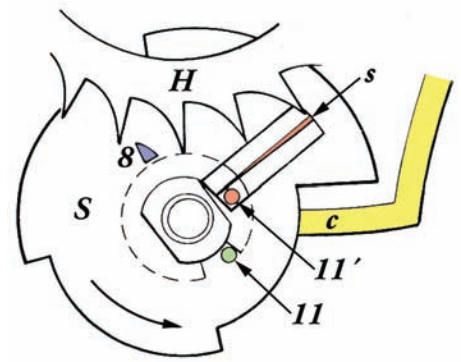

Figure 96

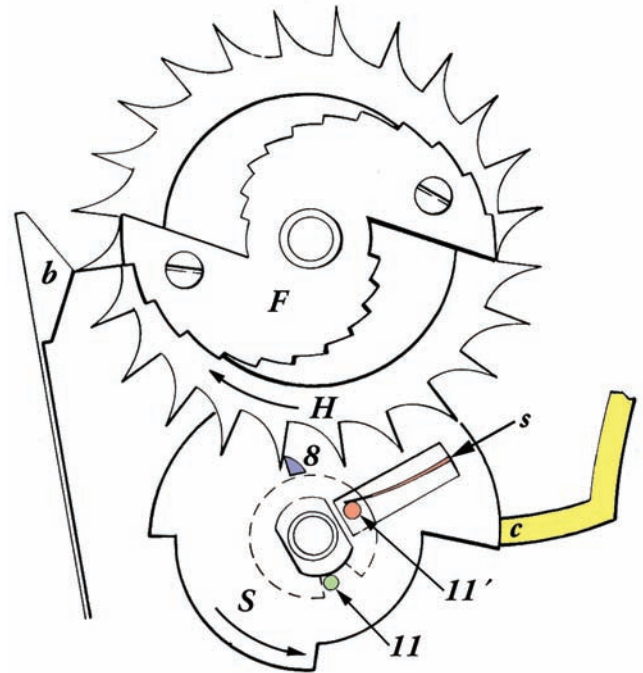

Figure 97

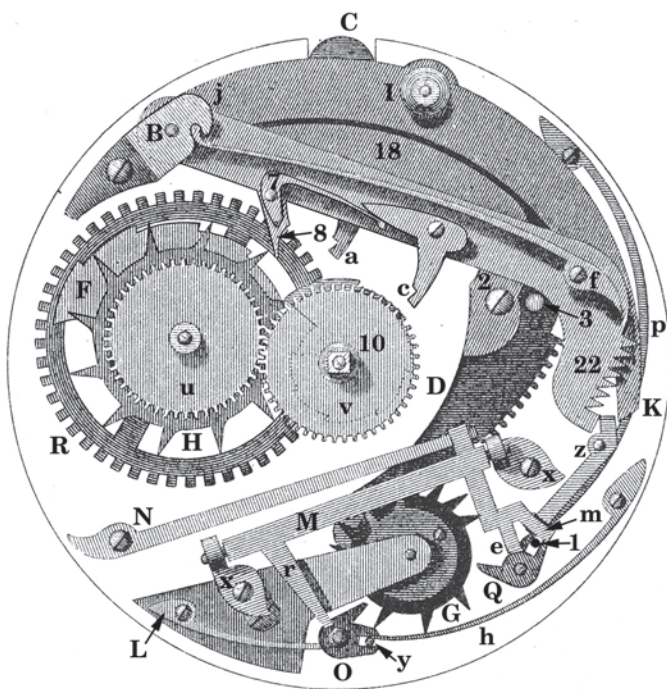

Figure 98 Stogden repeater at rest

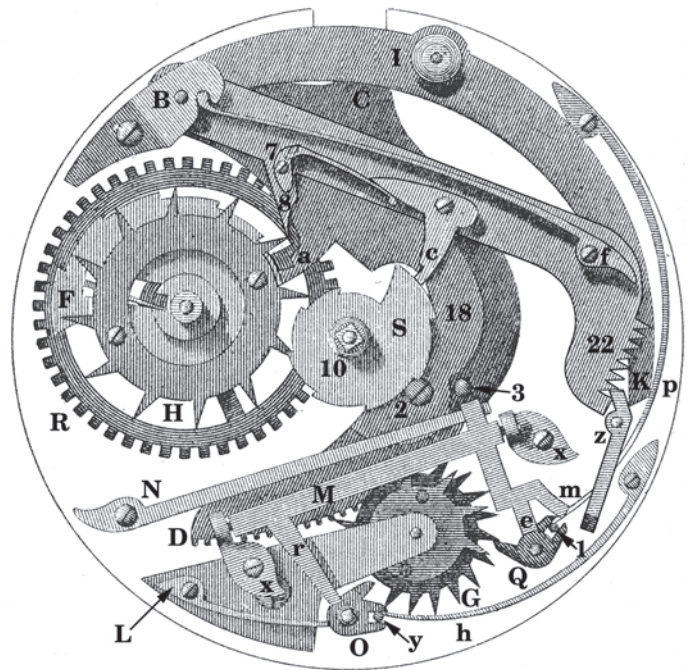

Figure 99 Stogden repeater ready to strike

Chapter 5: The IWC Minute Repeater

Introduction

The International Watch Company's Grande Complication, Figure 100, is described in detail in the massive book *The Grande Complication by IWC*, Edition Stemmler, by Manfred Fritz. This book, which serves as an owner's manual, has two explanations of the minute repeater, one by Fritz and a "technical description" by Robert Greubel and Jürgen King. Both explain the mechanism in isolation, without any reference to other repeaters, and both use the terminology and parts numbering system developed by IWC. This repeater is probably the first genuinely new design for over 200 years.

The lack of context makes it difficult to understand the action of the repeater, especially for anyone who has no previous experience with such watches. In contrast, by viewing the mechanism in context it is possible to distinguish between those parts of the mechanism which derive from earlier repeaters and those which are new. For example, the quarter counting and striking mechanisms date back to before 1740, whereas the minute counting mechanism is completely different from the methods used in other repeaters. By placing this repeater in context, we can focus upon the technically innovative aspects.

The Grande Complication has the following complications:

- Automatic winding.
- Chronograph with 30-minute and 12-hour counters.
- Minute repeater.
- Moon phase.
- Perpetual calendar with day of week, day of month, month and year displays.

In total, there are 568 individual components in the movement and these have to be arranged so that they effectively function together. To do this, the watch is built up in seven basic layers:

- Dial.
- Perpetual calendar and moon phase.
- Minute repeater.
- Motion and keyless work.
- Going train.
- Chronograph.
- Automatic winding.

Because the chronograph and going train must communicate with the dial, there are arbors that pass through the minute repeater and perpetual calendar layers to the appropriate places on the dial. One example is the link between the motion-work of the watch and the perpetual calendar, Figure 103 *, which passes through the repeater layer.

The IWC Grande Complication took 7 years to design, starting in 1983, and was first manufactured in 1990. To help recover the very high cost in time and money (measured in millions of dollars) IWC developed the *Portuguese* range of watches based on it, each having only one or two complications; the Portuguese repeater is a manual-winding minute repeater consisting of only the basic movement and repeater from the Grande Complication. Since then the repeater has been used in other IWC watches, including the *Il Destriero Scafusia*, which is a grand complication having a minute repeater, tourbillon, perpetual calendar with moonphase, and split seconds rattrapante chronograph.

Going train and motion work

The repeater mechanism must have access to the time-of-day. This is usually provided by the going train through the canon pinion, which gives information on a 60 minute cycle, and the other time units are determined by the repeater mechanism itself. However, in order to integrate the complications successfully, the IWC engineers had to use an innovative design for the basic movement.



Figure 100

The IWC Minute Repeater

Figure 101 shows the going train of the IWC Grande Complication. It has three very important features:

- The train uses very high numbers of wheel teeth and pinion leaves, and an escape wheel with 20 teeth instead of the usual 15. This provides a much better transmission of power from the barrel to the balance.
- The second wheel *y* of the train, normally called the center wheel, is not planted in the center of the movement but is off-center.
- This second wheel rotates once in 50 minutes instead of the usual 60 minutes.

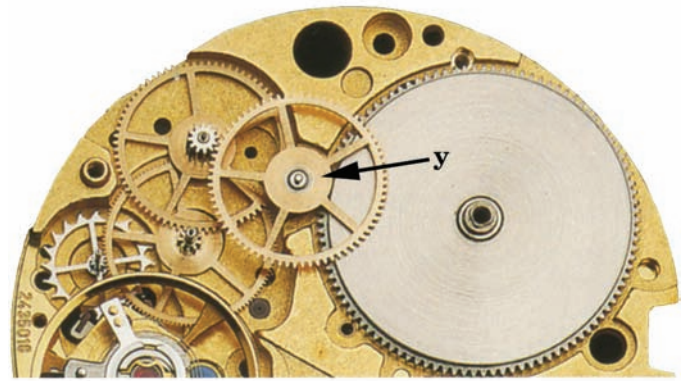

Figure 101

As a consequence of this arrangement, the watch uses the same type of motion work as in the eight-day travelling clock previously described and shown in Figure 72 of Chapter 3, page 37.

Figure 102 shows the motion-work of the IWC watch, which is mounted on the outside of the going train bottom plate, underneath the repeater work.

The canon pinion (Figures 102 and 103 *D*) is mounted loose on a pipe fixed to the bottom plate. The *minute-wheel-driver* is mounted friction tight on the center wheel arbor and can turn separately to allow hand setting. The minute-wheel-driver drives the *minute-wheel* which rotates *anti-clockwise* once in 90 minutes or 1½ hours, and this wheel drives both the canon pinion and the hour wheel.

The repeater obtains the time-of-day from the minute-wheel arbor. Because this wheel rotates once in 90 minutes, the repeater is based on a six-quarter cycle instead of the usual four-quarter cycle. And it rotates backwards! Having fixed on this unusual motion-work, IWC's designers had to create a minute repeater which is significantly different from those we have examined previously. The obvious result of this is that the piece that looks like a minute-snail, Figure 103 *S'*, has six arms instead of the normal four, but there are many, much more subtle features of this unique repeater.

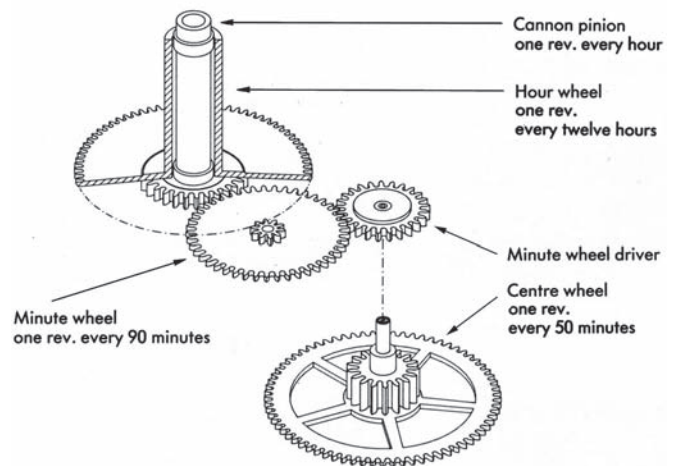

Figure 102

Overview

The most important point regarding the repeater is that it is based on the simplified quarter repeater mechanism shown in Figures 43 and 44 of Chapter 2, page 24 on; the *quarter-counting piece 22*, or *hand*, its stop *23* and its *gathering pallet r'* can be seen in Figure 103. To this has been added a *minute-counting mechanism T* and *c'*, and a *minute strike-rack N'*.

The addition of the minute strike-rack has three important consequences:

- In the simplified quarter repeater the rotation of the *repeater-spring arbor*, Figure 103 *9*, is halted when the quarter-counting piece is jammed between its stop and the quarter-counting piece gathering-pallet (see Figure 43 and the discussion of it in Chapter 2, page 24). But in this repeater, in order to strike the minutes, the repeater-spring arbor must continue to rotate after striking the quarters.
- While the repeater-spring arbor continues to rotate, to strike the minutes, the *hour-quarter strike-rack G* must not rotate; if it did too many quarters would sound.
- The simplified quarter repeater does not have an all-or-nothing mechanism, because there is no component which can lock and unlock the hammer pallets. The addition of the minute strike-rack provides such a component and the IWC repeater has an *all-or-nothing mechanism*, Figure 103 *j-I-K*, which is composed of two separate pieces.

The most significant difference between this repeater and the others we have examined is the minute-counting mechanism. All other minute repeaters that I know of use a conventional minute-snail attached to the canon pinion and a normal minute counting and striking mechanism. But this was not possible in the IWC Grande Complication because the canon pinion could not be used. This had one very serious consequence:

The IWC Minute Repeater

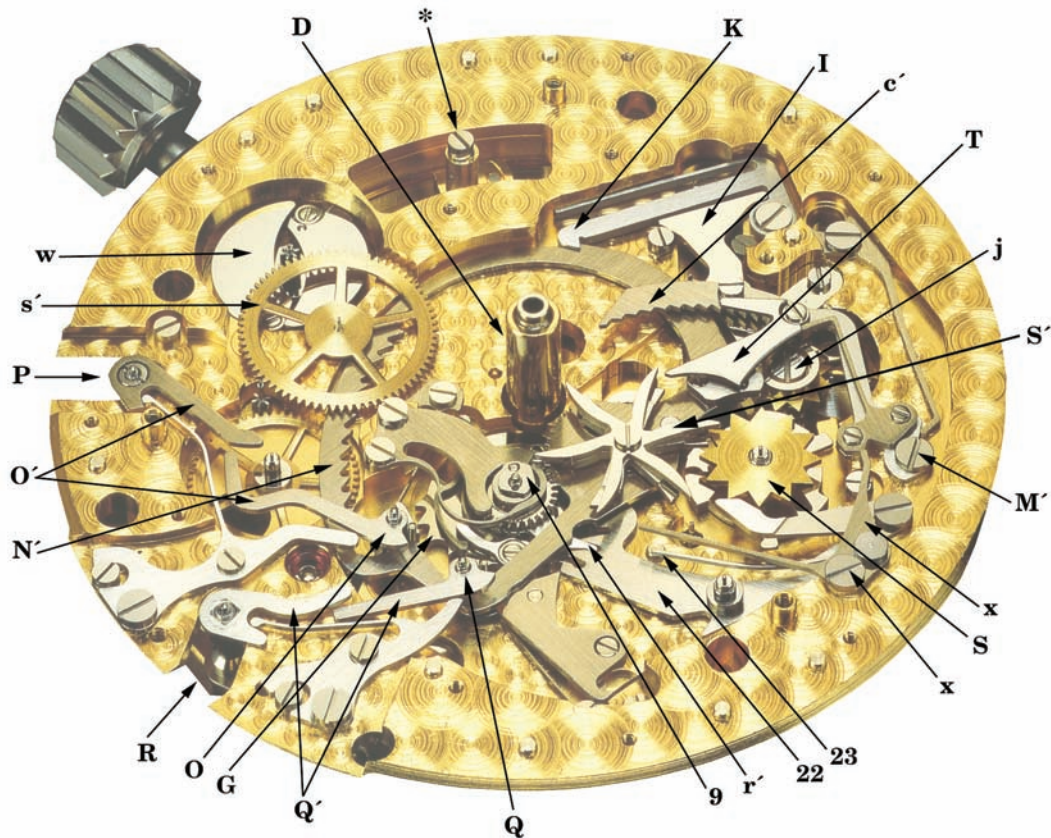

Figure 103

The watch has a $13\frac{1}{4}$ ligne, 30 mm, basic movement (going train, chronograph and automatic winding), and the diameter of the minute repeater plate is $15\frac{1}{2}$ ligne, 35 mm. From Figure 103 we can conclude that the innermost, 14-minute, steps on a six-arm minute-snail the size of S' would be only about 0.05 mm wide (0.002 inch), and the outermost, zero-minute, steps would be about 0.24 mm wide (0.009 inch). Consequently the width of a minute-rack snail-arm could be at most about 0.03 mm (0.0012 inch), which is not practical. (S' has an outer radius r of 3.45 mm, and the inner radius r' corresponding to the 14-minute step is about 0.67 mm. The width of a step on a snail covering 90 minutes is $2\pi x/90$, where x is the radius of the step. The height of the steps is $(r - r')/14$.)

Further, the height of the steps on a minute-snail, and consequently the movement of the snail-arm from one step to the next, dictates the spacing and size of the minute strike-teeth. Because this is very small, an amplification mechanism is used. For example, in the minute repeater in Chapter 3 Figure 59 (page 32), $N'-M-c'$ is a lever pivoted at M . And the size of a minute strike-tooth N' is related to the minute-snail step height by the ratio of the lengths of the lever arms $N'-M$ and $M-c'$. In the case of the IWC repeater, the snail step height would about 0.19 mm (0.0075 inch) and considerable amplification is needed in order to have large enough strike teeth.

To overcome these problems, a completely different *minute-counting mechanism* is used.

Three other features should be noted:

- The *quarter-snail*, with its star-wheel, Figure 103 S , is mounted beside the *minute-snail* S' . It is driven by the minute-snail in the same way as the hour-snail in a traditional repeater.
- The quarter-snail drives the hour-snail and its star-wheel, which are attached to the all-or-nothing mechanism at j .
- There is a single hammer pallet Q for both hour and quarter striking on the large hammer, and two, superimposed hammer pallets O for quarter and minute striking on the small hammer. These hammer pallets are located away from the edge of the movement and so they operate the hammers R and P by the levers Q' and O' .

The other labelled components in the general view in Figure 103 will be described later.

The IWC Minute Repeater

Winding and the repeater train

The *winding-rack*, Figures 104 and 106 C, is the same as in other repeaters. It winds the repeater-spring clockwise through the *winding-pinion* z squared onto the repeater-spring arbor 9 , and the movement of the winding-rack is limited by the pin a which meets a step of the hour-snail F mounted above it.

The winding-rack is not visible in Figure 103 because it lies above the going train bottom plate and underneath the repeater mechanism.

The *repeater-train* does not use a conventional ratchet and click. Instead it uses the *freewheel* 2 and its separate *freewheel pinion* 1 , shown in profile in Figure 105.

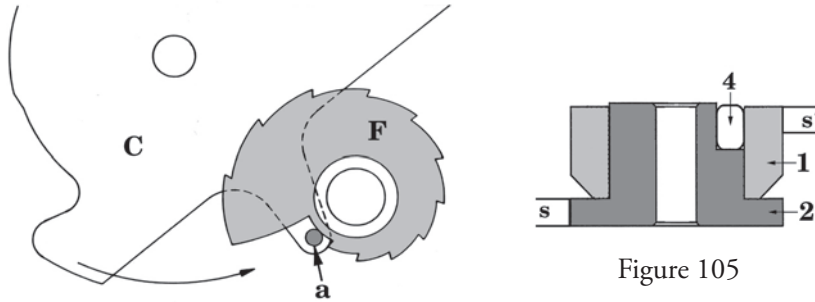

Figure 104

Figure 105

The first wheel of the repeater train, s , drives the freewheel 2 , Figure 106, and the freewheel pinion 1 drives the second wheel s' , Figure 107. The only connection between the freewheel and its pinion is the *roller* 4 , which is held in position by the *freewheel spring* 3 .

When the repeater is wound, in the direction of the arrows in Figure 106, the *hub* of the freewheel 2 rotates clockwise, causing the roller 4 to rotate anti-clockwise towards the spring, so that it is not pressed tightly against the freewheel pinion; and so the freewheel pinion and the repeater train remains stationary. (There will be a light contact between the roller and the pinion, but not enough to overcome the inertia of the repeater train.)

During striking, Figure 107, the freewheel rotates anti-clockwise and, with the help of the spring, causes the roller to rotate clockwise so that it is wedged between the freewheel 2 and its pinion 1 ; and the repeater train runs, controlling the speed of striking. The train ends in a centrifugal fly as described at Figure 40 in Chapter 2, page 22.

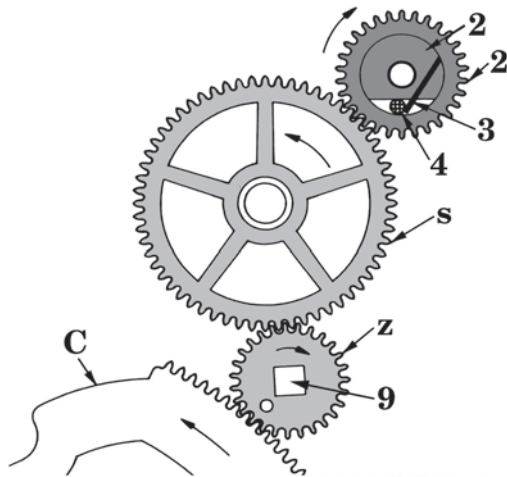

Figure 106

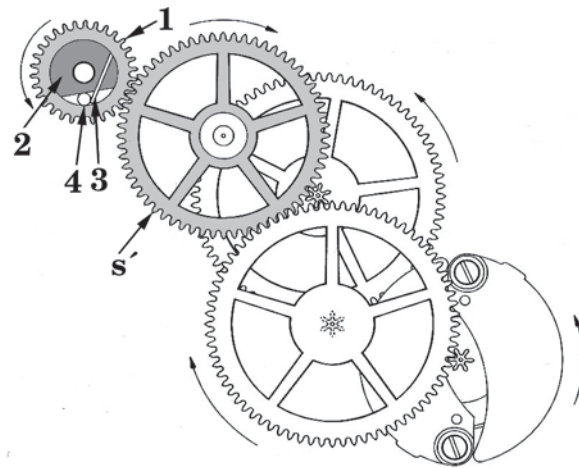

Figure 107

The quarter and hour snails

As shown in Figure 108, the *minute-snail* S' (described later) and the *quarter-snail driver* $8'$ are attached to the motion-work minute-wheel arbor M . Both have 6 arms corresponding to the 6 quarters covered by the minute-wheel in one rotation. Note that they rotate anti-clockwise. This is the reverse of other repeaters where the minute-snail is attached to the canon pinion and rotates clockwise.

The quarter-snail and its *star-wheel* H' are mounted beside the minute-wheel arbor, so that the star-wheel is rotated clockwise by the quarter-snail driver.

The IWC Minute Repeater

A quarter-snail normally has only 4 steps, and so its star-wheel would have only 4 rays. It would be very difficult to design a driver that could turn the star-wheel and snail through 90°, and so this watch has a quarter-snail which covers three hours and has 12 steps (the snail is shown in Figures 110, 111 and 112). Consequently, the quarter-snail star-wheel H' has 12 rays, and the action of the quarter-snail driver is the same as the hour-snail driving mechanisms in other repeaters.

As shown in Figure 109, mounted on the quarter-snail arbor, from top to bottom, are the star-wheel H' with its jumper b' , the *hour-snail driver* 8 (green), and the quarter-snail S . The hour-snail driver has 3 arms corresponding to the 3 hours covered by the quarter-snail in one rotation.

The *hour-snail* F and its *star-wheel* H are mounted beside the quarter-snail. They are turned anti-clockwise every hour by the hour-snail driver in the same way as in an ordinary repeater.

Using a round pin a (Figure 104) for the hour-snail arm has an interesting consequence. When the hour changes the hour-snail is being driven anti-clockwise by the hour-snail driver 8 and it cannot be rotated clockwise. But it *can* rotate anti-clockwise. For example, if the pin lands on the edge of step 2 then it will rotate the hour-snail a little anti-clockwise and sit on step 1. (If the pin lands on the edge of the 12 step, it would try to rotate the hour-snail clockwise, which is impossible.)

However, this movement of the hour-snail cannot happen, because the jumper spring will have already advanced the hour-snail and the pin will sit comfortably on the next step.

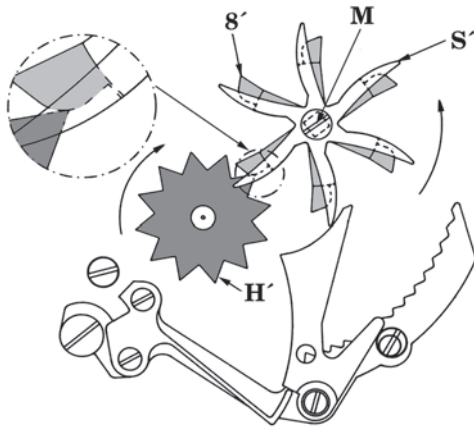

Figure 108

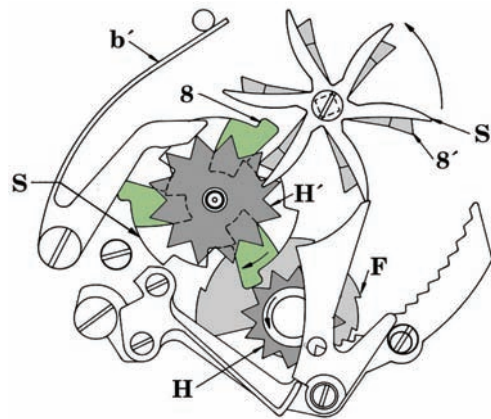

Figure 109

Hour and quarter striking

Hour and quarter counting and striking are the same as that described by Thiout in 1741 and shown in Figures 43 and 44 of Chapter 2, page 24 on. After the hours and quarters have struck, the repeater-spring arbor must continue to rotate to strike the minutes. This complication means that the *strike-rack gathering pallet* r , Figure 110, and the *quarter-counting piece gathering pallet* r' are designed differently from those used in the simplified quarter repeater.

The strike-rack gathering pallet, Figure 110 r , is squared onto the repeater-spring arbor, and the strike rack G is loose on that arbor. The quarter-counting piece gathering pallet r' is mounted on the strike rack and it meshes with the strike-rack gathering pallet r .

During winding, Figure 110, the strike-rack gathering pallet r meshes with the quarter-counting piece gathering pallet r' which rotates the strike rack G clockwise. At the same time, the quarter-counting piece gathering pallet r' moves out of mesh with the quarter-counting piece 22 and it drops onto the quarter-snail under the pressure of its drop-spring f . To ensure the quarter-counting piece gathering pallet cannot jam, it is held between two springs g and can move further into the slot in the strike-rack gathering pallet if required to free the quarter-counting piece. The strike-rack rotates until the required number of hour-teeth have passed the large hammer pallet Q , as determined by the hour-snail.

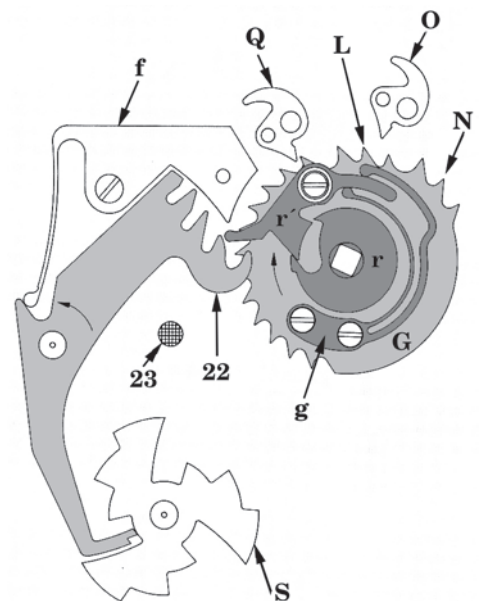

Figure 110

The IWC Minute Repeater

During striking, Figure 111, the strike-rack gathering pallet r rotates the quarter-counting piece gathering pallet r' , and hence the strike rack G , anti-clockwise, striking the hours.

Then the quarter-counting piece gathering pallet r' meets the quarter-counting piece 22 and rotates it clockwise until it meets the stop 23 , which prevents the strike rack rotating further. How many quarters are struck depends on which of the four gaps, between the “fingers” of the quarter-counting piece, the quarter-counting piece gathering pallet enters, and this is determined by the quarter-snail S . The at-rest position of the strike-rack is with the hammer pallets O and Q in front of, behind, or between the quarter-striking teeth, depending on the position of the quarter-snail.

In the simplified quarter repeater (Chapter 2 Figure 43, page 24), at this point the quarter-counting piece gathering pallet r' is jammed by the stop 23 and the strike-rack gathering pallet r cannot rotate further anti-clockwise. So the repeater-spring arbor also stops rotating.

However, the IWC repeater must continue functioning to sound the minutes, and consequently there must be a way to allow the repeater-spring arbor to continue rotating after the hours and quarters have sounded. To achieve this, when the quarter-counting piece 22 meets its stop 23 the pressure on the gathering pallet r' causes it to rotate slightly around its pivot point, and lifts it above the rim of the strike-rack gathering pallet r . The strike-rack gathering pallet can then continue to rotate as in Figure 112, allowing the minutes to strike. During this time the strike-rack and the quarter-counting piece are motionless.

Thus the at-rest state of the repeater is with the quarter-counting piece gathering pallet r' resting on the outside of the strike-rack gathering pallet r and the quarter-counting piece 22 locked as described above.

When the repeater is activated, the first stage of winding rotates the strike-rack gathering pallet r clockwise until the quarter-counting piece gathering pallet meets the slot and drops into it. Then, as described above, the strike-rack gathering pallet and the quarter-counting piece gathering pallet continue to rotate together until all the quarter strike-teeth and the correct number of hour strike-teeth have passed the hammer pallets.

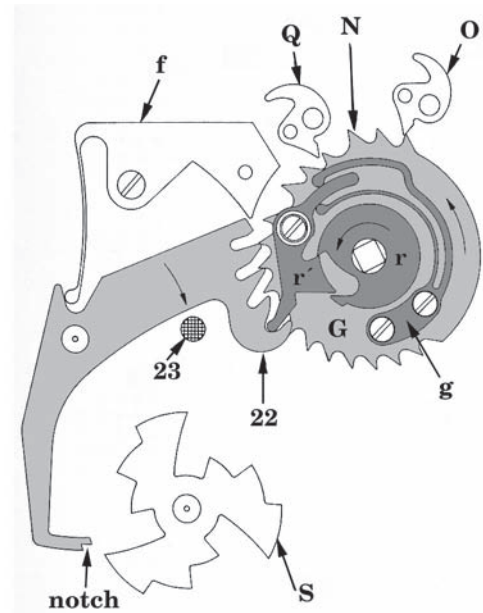

Figure 111

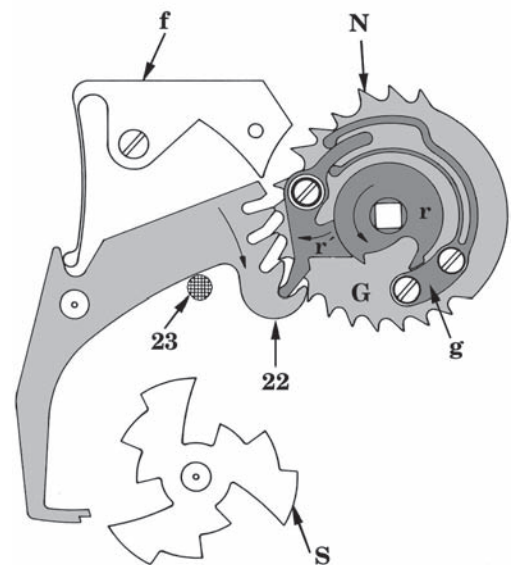

Figure 112

Minute counting and striking

The minute counting mechanism, Figures 113 and 114, consists of the *minute-snail* S' (which replaces the normal minute snail), and the *minute-counter* $M'-c'-T$. The minute-counter consists of two pieces. The main part $M'-T$ pivots at M' . The piece c' is free and is held against the eccentric screw * by the spring t ; the eccentric screw enables the minute-counter to be adjusted so that the steps on T correctly count the 0 to 14 minutes.

The minute-counter is always in contact with the minute-snail. As the motion-work minute-wheel rotates, the minute-snail rotates anti-clockwise with it, and the *tips* of its arms slide across the curved face c' of the minute-counter, causing the minute-counter to rotate clockwise around its pivot point M' .

The extreme, when the minute-counter has rotated the maximum amount, Figure 113, corresponds to 14 minutes.

The other extreme when the minute-counter has rotated the least amount, Figure 114, corresponds to zero minutes. Note that this behaviour is the reverse of the action of a normal minute-snail and it is similar to that of the half-quarter snail in Stogden's repeater (page 42).

Figure 115 shows the positions of the minute-snail and the minute-counter at 5 minutes. Clearly the shape of the curved face of c' is critical, and it was mathematically calculated to ensure that the steps on T correctly count the minutes.

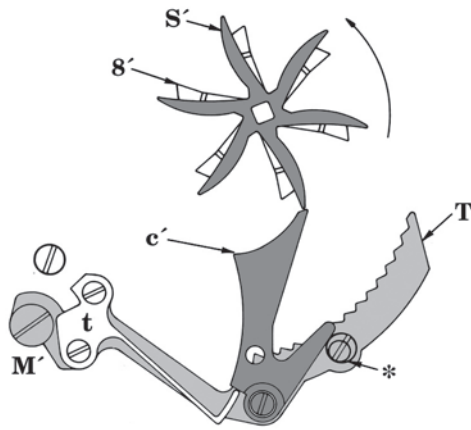

Figure 113

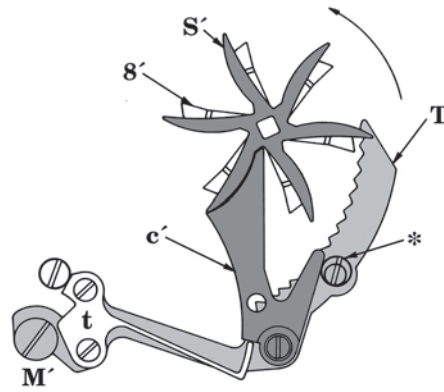

Figure 114

Minute striking is performed by the *minute-rack*, Figure 115 $X-N'$. This rack pivots around the minute-snail arbor M , and it is driven by the *minute-rack pinion* z' mounted on the repeater-spring arbor 9 .

When the minute-rack drops, rotating anti-clockwise under the pressure of its drop-spring, its movement is limited by the *minute-rack minute-counter arm* c coming to rest on a step of the minute-counter T . This movement allows the correct number of minute-strike teeth N' to pass the small-hammer pallet O .

Minute striking occurs when the minute-rack pinion z' , Figure 115, rotates the minute-rack clockwise, and the pallet O trips the small-hammer P via the levers O' .

(As is clear from Figure 117, the strike rack G and the minute-rack $X-N'$ are on different levels. And so there are actually two superimposed pallets at O .)

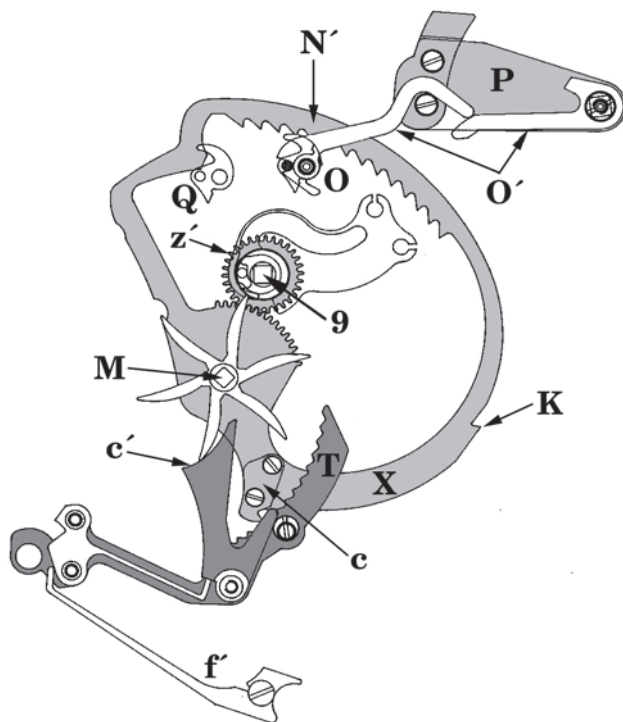

Figure 115

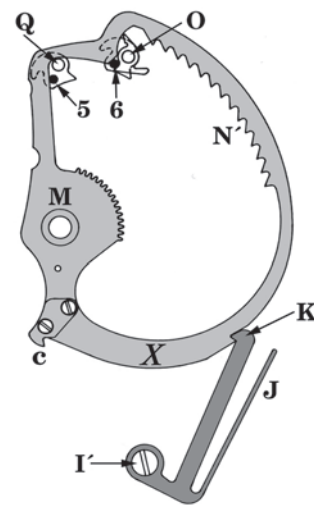

Figure 116

All-or-nothing mechanism

The all-or-nothing mechanism is easy to understand because it is similar to that of the continental quarter repeater. The main difference is that it acts on the minute-rack instead of the quarter-rack.

The minute rack, Figures 115 and 116 $X-N'$, pivots at M , the minute-snail arbor. It is prevented from dropping by the *all-or-nothing detent* at K .

The pallets Q and O each have a pin, 5 and 6 respectively. When the minute-rack is held in its at-rest position, as in Figures 116 and 117, it presses against these pins to hold the hammer pallets out of mesh with the strike-rack. And so no striking can occur until the minute-rack is released.

The IWC Minute Repeater

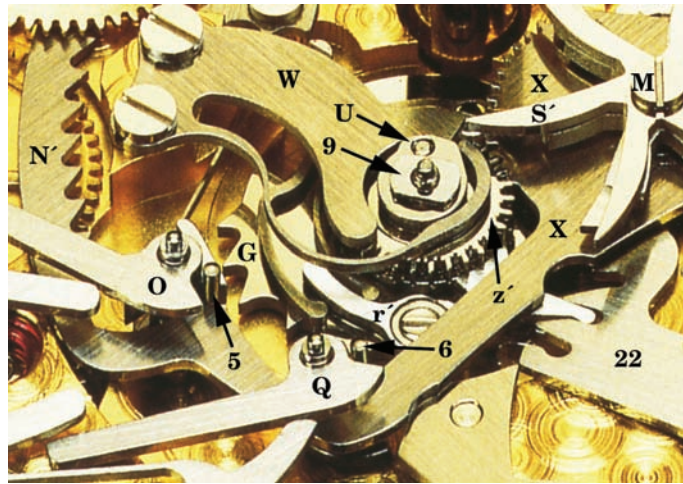

Figure 117

The all-or-nothing mechanism, Figure 118, consists of two pieces. The *all-or-nothing piece 10* pivots at *I*. Attached to it, by a shoulder screw at *j*, are the hour-snail *F* and the hour-snail star-wheel *H*; *b* is the star-wheel jumper spring. When the repeater is activated, the winding-rack hour-snail pin *a* pushes against the hour-snail and causes the all-or-nothing piece to rotate clockwise.

This, in turn, causes the *all-or-nothing detent piece I'-K-J* to rotate clockwise around its pivot *I'* and release the minute-rack. The *all-or-nothing spring J* maintains the lock on the minute-rack except when the all-or-nothing mechanism is activated. Movement of the all-or-nothing piece is restricted by the two screws *.

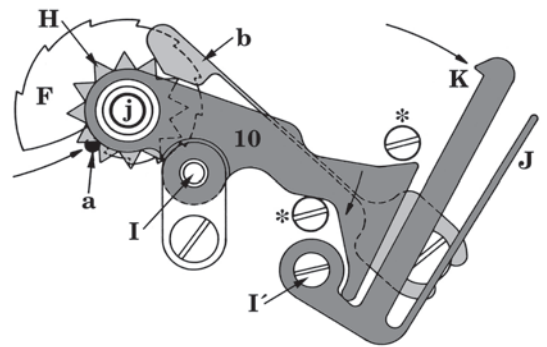

Figure 118

Minute strike control

When the repeater is at rest, the minute-rack cannot move, being locked by the all-or-nothing detent piece. So when the repeater is wound and the repeater-spring arbor, Figures 115 and 117 *9*, rotates clockwise, the minute-rack cannot move and the minute-rack pinion *z'* cannot rotate.

During striking, when the repeater-spring arbor rotates anti-clockwise, the minute-rack has been released and can move, but it must not move until after the hours and quarters have struck. So the minute-rack pinion *z'* must not start rotating until the minutes are to be struck.

To achieve this, the minute-rack pinion *z'* is not squared onto the repeater-spring arbor, but it is loose, and the *minute-strike control mechanism* activates it at the correct time. This mechanism uses a roller working on the same principle as that used to drive the repeater train.

The *minute-driver*, Figure 119 *V*, is squared onto the repeater-spring arbor and fits snugly but loose inside the minute-rack pinion *z'*. Thus normally the minute-rack pinion will not rotate when the minute-driver rotates.

The *minute-roller piece U'* sits above the minute-driver *V* and the minute-rack pinion *z'*. It is loose, but it has a roller, Figures 117 and 119 *U*, which fits between the minute-driver and the minute-rack pinion in the irregular cut-out on the edge of the minute-driver, and so it is rotated by the minute-driver.

In the position in Figure 119, the minute-roller piece *U'* is *eccentric* with respect to the minute-driver and the minute-roller is held away from the inside edge of the minute-rack

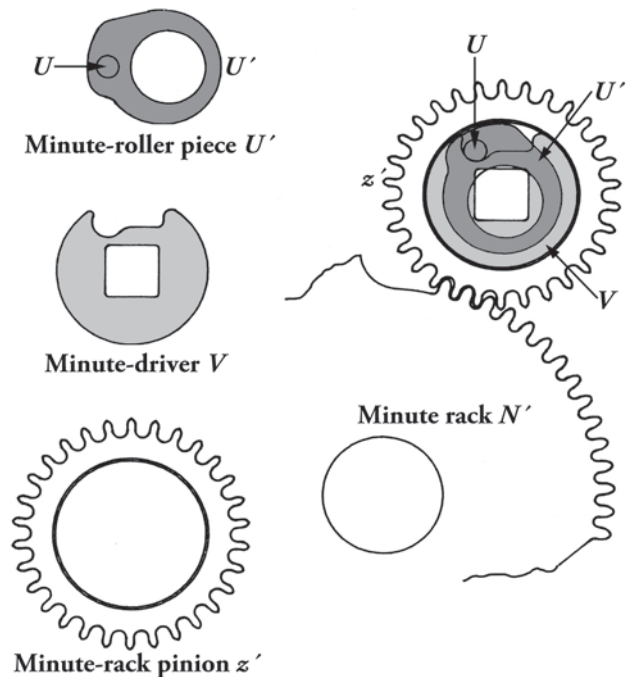

Figure 119

The IWC Minute Repeater

pinion. So there is no connection between the minute-driver and minute-rack pinion; the minute-rack pinion will remain stationary while the minute-driver rotates. However, if the minute-roller piece U' is rotated clockwise relative to the minute-driver V , then the roller U will be wedged between the minute-driver and the minute-rack pinion z' and both will rotate together, as shown in Figure 120. The minute-roller piece is now *concentric* with respect to the minute-driver.

What is now required is a mechanism to control the position of the minute-roller piece U' relative to the minute driver V , and this achieved by the *minute synchroniser*, Figures 117 and 121 W .

First, note that the minute-rack is *always* unlocked and locked by the all-or-nothing mechanism, irrespective of the number of minutes to be sounded. That is, the minute-roller must always be wedged between the minute-driver and the minute-rack pinion, to raise the minute-rack and lock it at the end of striking. Figure 121 shows the at-rest position after striking 3 quarters and zero minutes. Immediately after the quarters have struck, the minute-rack pinion z' rotates to lift the minute-rack the small amount necessary for the all-or-nothing mechanism to lock. At which point the minute-driver V , and consequently the repeater-spring arbor, cannot rotate further and the repeater stops. If 14 minutes are to strike, then the minute-rack drops as far as it can. So, after the minute-roller has wedged between the minute-driver and the minute-rack pinion, as in Figure 121, the repeater-spring arbor, the minute driver and the minute-rack pinion will continue rotating until all 14 minutes have sounded and the minute-rack has been locked. Figure 117 shows this at-rest position.

When the repeater is activated, the repeater-spring arbor and the minute-driver are rotated clockwise, but the minute-rack is locked and so the minute-rack pinion *cannot* turn. The clockwise rotation of the minute-driver causes the minute-roller to rotate anti-clockwise so that it drops away from the minute-rack pinion and the minute-driver can continue rotation without the minute-rack pinion moving. This continues until the minute-rack is unlocked by the all-or-nothing mechanism; in Figure 122 it is when one hour is to strike. Then the minute-rack drops anti-clockwise with the minute-rack pinion freely rotating clockwise, Figure 116.

During striking of the hours and quarters, Figure 122, the minute-roller piece is held by the body of the *minute synchroniser* W so that the roller remains in the slot on the minute-driver, and consequently the repeater-spring arbor, the minute-driver and the strike-rack rotate anti-clockwise without the minute-rack pinion moving.

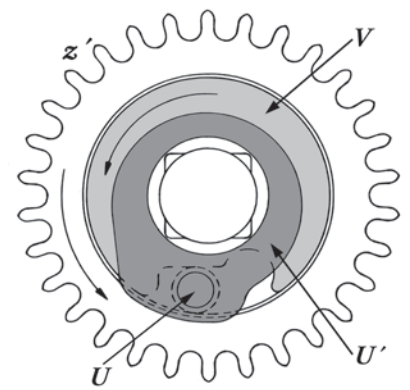

Figure 120

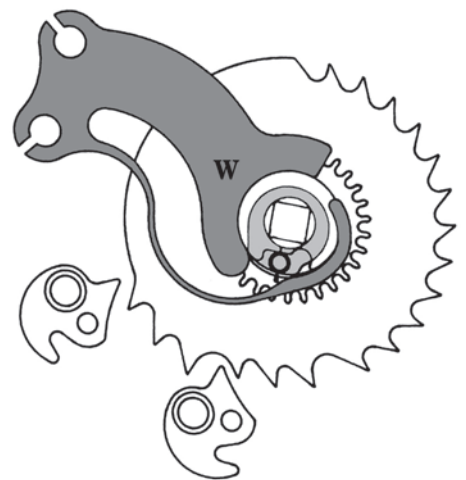

Figure 121

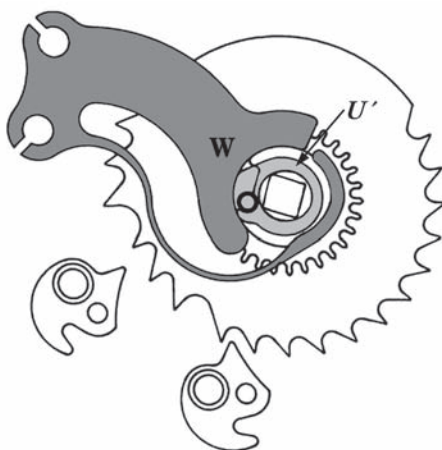

Figure 122

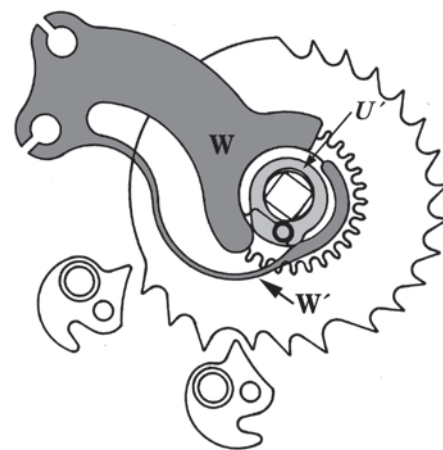

Figure 123

However, when the repeater-spring arbor has rotated sufficiently far to strike the hours and three quarters, Figure 123, the minute-roller piece U' meets the minute synchroniser spring W' . The spring retards the motion of the minute-roller piece and presses the roller against the minute-driver. As a result, the roller is forced to rotate clockwise, lifting it out of the slot so that it jams between the minute-driver and the minute pinion, as in Figure 121. And so the minute-rack pinion rotates anti-clockwise with the minute driver, lifting the minute rack and striking the minutes.

The IWC Minute Repeater

The repeater-spring arbor

With the exception of the nut, which holds everything together, all of the other 9 parts mounted on the repeater-spring arbor **9** have been described. As shown in Figure 124, these are, from top to bottom:

- (a) The minute roller piece and its roller *U* (loose on the arbor).
- (b) *z'*, the minute-rack pinion (loose).
- (c) *V*, the minute-driver (squared).
- (d) *r*, the strike-rack gathering pallet (squared).
- (d) *r'*, the quarter-counting piece gathering pallet, and the quarter-counting piece gathering pallet spring *g* (screwed to the strike-rack and so loose).
- (e) *G*, the strike-rack (loose).
- (f) The repeater-barrel and spring.
- (g) *z*, the winding rack pinion (squared onto the arbor).

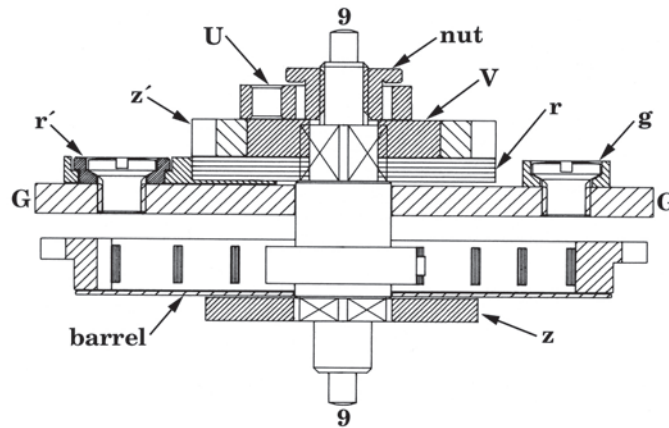

Figure 124

Strike timing

First, because this repeater is based on the simplified quarter-repeater, the basic action is the same as in Chapter 2 Figures 45 to 48, page 25 on. That is, the quarters always strike immediately after the hours.

Figures 125 and 126 shows the striking for 3 hours 59 minutes. When the repeater is activated, the repeater-spring arbor rotates clockwise so that all minute, quarter, and 3 hour strike teeth pass the pallets. Figure 125 shows the repeater at this point, when the push-piece is about to be released to allow the repeater-spring arbor to unwind anti-clockwise. The repeater strikes 3 hours (yellow) followed by a short period of silence (white, 3 quarters (green), 14 minutes (red), and another short period of silence (white) while the minute-rack is raised to be locked by the all-or-nothing mechanism. At this point, the repeater-spring arbor is in the at-rest position shown in Figure 126, ready to be activated again.

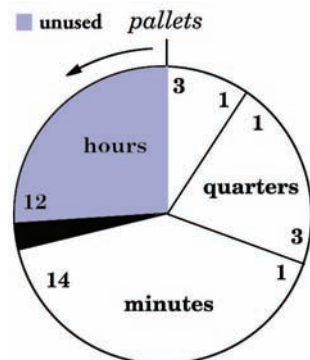

Figure 125



Figure 126

If the repeater is now activated at 4 hours 16 minutes, striking will be that shown in Figures 127 and 128.

With the exception of the number of hours, when the repeater is activated the position in Figure 127 is the same as in Figure 125. When striking takes place, Figure 128, we hear 4 hours (yellow), a short period of silence (white), 1 quarter (green), and then an extended period of silence (white) before the single 1 minute (red) followed by the short period of

The IWC Minute Repeater

silence (white) as the minute-rack is raised and locked by the all-or-nothing mechanism. When the minute-rack is locked the repeater-spring arbor cannot rotate and Figure 128 is the at-rest position after striking.

The worst case, striking a full hour and no minutes, requires the listener to wait for a long time after the hours have struck to be sure that no minutes are struck.

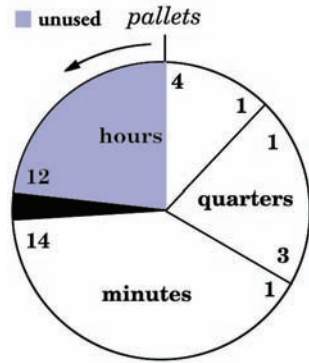

Figure 127

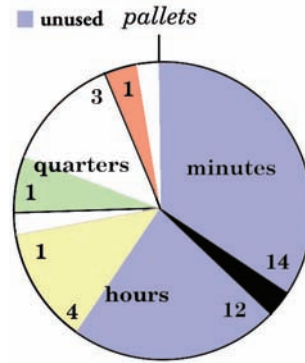

Figure 128

The isolator

The minute-counter, described earlier, has a very important feature: it is *always* held against the minute-snail by the *minute-counter drop-spring*, Figures 115 and 130 *f'*. And so power from the going train, through the motion-work, must be used to raise up the minute-counter against the force of the minute-counter drop-spring.

The isolator, Figure 129 *x*, was designed to overcome this problem by holding the minute-counter away from the minute-snail except when the repeater is activated. So Figure 129 shows the at-rest position. Here the isolator, under the pressure of its integral spring, has rotated the minute-counter clockwise until the end of the isolator moves onto the end of the minute-counter, locking it in that position.

When the repeater is activated, Figure 130, the winding rack acts on the isolator pin *x'*, lifting the isolator away from the minute-counter, enabling the minute-counter to drop onto the minute-snail. And throughout striking the isolator is held in this position by the winding rack.

When striking ceases, the winding-rack releases the isolator pin, allowing the isolator to press against the minute-counter and raise it away from the minute-snail.

In addition to the great time and expense, developing a new design is fraught with dangers. In particular, although a prototype might work satisfactorily, there is no guarantee that production watches will do so. And unfortunately it was found that there were two major problems with the isolator.

First, after striking, when the isolator was released, it could not lift up the minute-counter. As a result, the minute-counter remained in contact with the minute-snail until about the 14th minute of a quarter. At that point the isolator arm could slide onto the outer face of the minute-counter and raise the minute-counter the remaining small amount to the at-rest position in Figure 129.

Second, “the isolator did not work as expected” and “the repeater mechanism had incredibly long adjustment times during mounting the delicate parts around the isolator and the isolator itself.” (Private communications from IWC, 1 and 21 February 2008.)

So, in 1992-93 the isolator was removed from the Grande Complication. Since then no IWC repeater has used an isolator.

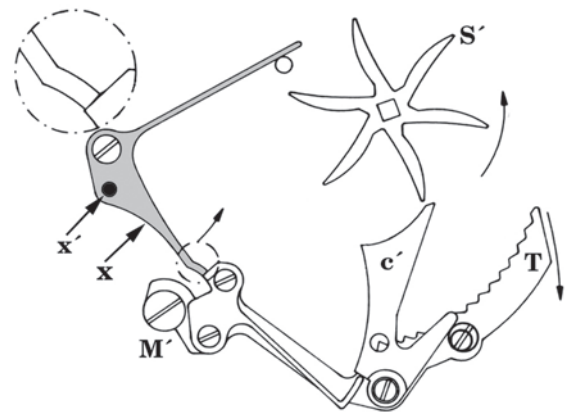

Figure 129

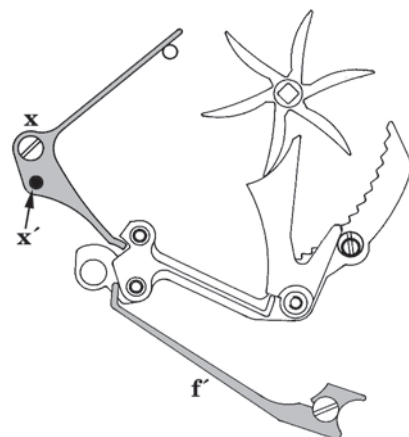

Figure 130

The IWC Minute Repeater

As noted above, removing the isolator leads to a decrease in power to the escapement, and IWC estimates this to cause “a loss of more or less 10° amplitude on the balance wheel’s swing”. In addition there might be brief and sudden reduction in power every 15 minutes caused by the minute-counter dropping off the tip of one arm of the minute-snail onto the bottom of the next arm; this can be heard as a soft “click” every 15 minutes. The effect of these, if any, depends on the isochronism of the balance-spring. Also, there could be an increase of wear on the minute-snail and the minute-counter face c' , but IWC states that the isolator was removed “without negative effects”.

It is necessary, yet again, to stress that every part and every feature in a repeater serves some purpose, and it is not possible to properly understand a repeater unless the function and behaviour of everything is examined. So the above discussion of the isolator has been included because this part appears in the illustrations and has to be explained. However, the presence or absence of the isolator has no effect on the behaviour of the repeater; when the repeater is activated its parts assume the same positions as they have when there is no isolator.

Freedom and accuracy mechanisms

This and the following two sections make frequent references to illustrations that appear earlier in this chapter. In particular, the reader needs to refer to pages 59, 60 and 61.

An important consequence of using the minute-snail, and having both the quarter and hour snails loose with their positions controlled by star-wheels, is that problems with freedom are resolved very easily.

As explained in Chapter 1 (page 10), just before the end of the third quarter, and just before the change from 12 to 1 hours, the snails are being driven by the motion-work and can jam. Freedom for the hour and quarter snail arms is usually obtained by slightly narrowing the snail arms and/or the zero-quarter and one-hour steps of the snails. (The fact that the hours are determined by a round pin in the winding-rack makes no difference. The diameter of the pin defines the leading and trailing edges and the amount by which the 12 hour step must be widened.) Further, the use of loose hour and quarter snails with their positions controlled by a star-wheel means there can be no problems with the accuracy of hour and quarter striking. Essential for this to work are hour and quarter snail drivers that will advance the snail 15° against the pressure of the star-wheel jumper springs, and then allow the snails to instantly jump forward a further 15° to the correct position for the next hour. That is, the driver pushes the star-wheel to the tip of a ray and then the star-wheel pushes the driver which then controls accuracy.

There is no need for a freedom mechanism for the minute-snail. As shown in Figures 113 to 115 (page 61), because the minute-snail rotates anti-clockwise, there is simply no situation in which the minute-counter arm c' can prevent the minute-snail from rotating and so interfere with the motion-work or the going train. (The minute-snail can be rotated clockwise when setting the hands, in which case there is a risk that the motion-work can be stopped by the minute-counter arm, but this will be considered later.)

The remaining problem is the accuracy of minute striking. That is, very close to the end of a quarter, will the minute-counter arm c' sit on the tip of a minute-snail arm to strike 14 minutes, or will it drop into the space between two arms and strike zero minutes? Any inaccuracy could cause zero-minutes to strike before the change of quarter, or 14-minutes after the change of quarter.

So when the quarter changes, Figure 113 page 61, it is essential that the minute-counter arm c' sits on the tip of a minute-snail arm S' until, for example, 14 minutes 59 seconds, but one second later it must drop into the space between the arms.

To do this, the minute-snail arms have their tips removed so that they correspond to 14 minutes 0 seconds. Then, as shown in Figure 131, the minute-counter arm c' does not come to a point, as it should do in theory. Instead it has a flat end which is approximately 6° or 1 minute 30 seconds wide. (To accommodate this, the minute-snail arms are undercut so that this flat end can rest between two arms, as in Figure 114, page 61.)

At 14 minutes 0 seconds the *leading edge* of the minute-counter arm c' , which determines the time, arrives at the tip of a minute-snail arm. For the next 59 seconds or 4° , the tip of the minute-snail slides under the minute-counter arm c' , which rests safely on it throughout the 14th minute. But at exactly 15 minutes the minute-counter arm must drop off the tip of the minute-snail arm, and so the minute-snail must advance at least 2° . That is, to ensure accuracy at state transitions all three counters (the minute-snail, quarter-snail and hour-snail) must jump forward.

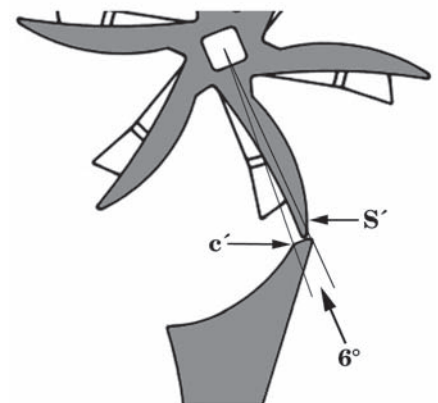

Figure 131

The IWC Minute Repeater

The IWC repeater achieves this by an *articulated arbor*, the concept of which is shown in Figure 132.

The arbor connecting the repeater to the motion-work is in two overlapping parts. The minute-snail S' and the quarter-snail driver $8'$ are rigidly attached to the arbor M (yellow) and the motion-work minute-wheel is rigidly attached to the arbor e (green). The minute-wheel arbor e is a semi-circle, but the minute-snail arbor M is 8° less than a semi-circle. Consequently, the minute-snail can flop about, in the same way as the quarter-repeater's freedom-piece and the minute-repeater's quarter-snail, the 8° corresponding to 2 minutes of time. The two halves of the arbor are held within a sleeve, on the outside of which is the bearing e' which supports the minute-rack.

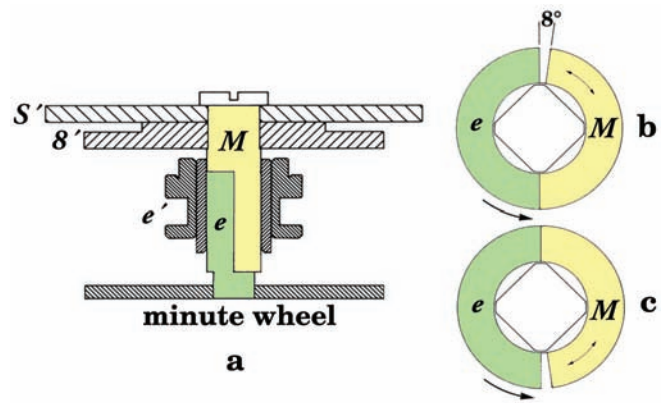

Figure 132

The minute-wheel arbor e is continuously driven anti-clockwise by the going train, and it drives the minute-snail arbor M , as in Figure 132b. However, if the minute-snail arbor is *advanced* 8° , as in Figure 132c, then it can remain stationary for 2 minutes until the minute-wheel arbor catches up to it.

The minute-counter arm, Figure 115 c' (page 61) is continually pressing against the minute-snail, rotating it clockwise, *retarding* it, to the position in Figure 132b. It is when the minute-wheel arbor e and the minute-snail arbor M are in contact in this position that the minute-snail correctly counts the minutes. (If the repeater has an isolator, then most of the time the minute-counter is held away from the minute-snail, which is free to flop about. Other just before and after the change of quarter this does not matter, because the minute-counter will land correctly on the minute-snail and move it to the retarded position. Near the change of quarter, the quarter-snail driver and the star-wheel jumper hold the minute-snail in the correct position.)

Some $3\frac{3}{4}$ minutes before the quarter changes, the quarter-snail driver, Figure 108 $8'$ page 59, starts pushing the star-wheel H' around against the pressure of its jumper spring. (The actual time depends on the design of the quarter-snail star-wheel and the driver. I assume the minute-snail must rotate 15° to rotate the star-wheel 15° and, as the minute-snail rotates once in 90 minutes, it turns 15° in 3.75 minutes.) To do this, the articulated arbor and the minute-snail must be retarded, as in Figure 132b, so that they are being driven by the minute-wheel. Thus, the action of the quarter-snail driver and the star-wheel ensures the minute-counter arm will sit correctly on the minute-snail up to 14 minutes 59 seconds.

Exactly on 15 minutes, when the minute-counter arm is resting on the top of a minute-snail arm as in Figure 131, the jumper spring passes over the point of a ray and pushes the star-wheel and snail around clockwise. And the next ray pushes against the back of the quarter-snail driver arm, forcing the quarter-snail driver and the minute-snail to rotate 8° anti-clockwise into the advanced position in Figure 132c. This causes the minute-counter arm to drop off the tip of the minute-snail arm.

There appear to be two problems with this process:

- The quarter and hour snails should advance 15° , but it seems that they can advance only 8° .
- At exactly 15 minutes the minute-snail advances 8° and so the minute-counter arm will drop onto it in the position for 2 minutes of the next quarter. So, if the repeater is activated at 15 minutes it could strike 1 quarter 2 minutes instead of 1 quarter 0 minutes.

But the repeater works correctly ...

12 hours 30 minutes

I have stressed the need to have a complete understanding of repeaters and, in particular, the need to examine the critical times when the repeater changes state, the most important being the change from 12 hours 59 minutes to one hour. However, other state changes are equally important, and I have chosen to look at what happens before and after 12 hours 30 minutes so that we can, for the moment, ignore the mechanism that advances the hour snail. To begin with I will look at what happens *after* the change of quarter, when the above problems occur. I will consider the case of a watch without an isolator and examine the effect of the isolator later.

As can be seen in Figure 108 (page 59), the quarter-snail driver is relatively narrow and it has about 7° of freedom between the rays of the star-wheel. This is the extra freedom to make up the required 15° .

The consequences of this can be seen in Figure 109 (page 59). This illustration is a snapshot taken just after the jumper has passed over the tip of a ray. The star-wheel has advanced 7° until it has met the back of the quarter-snail driver,

The IWC Minute Repeater

and it has to advance a further 8° under the pressure of the jumper spring b' . At this point the minute-snail has not yet been pushed anti-clockwise so the minute-counter arm is still registering 14 minutes. Two things now happen.

First, the star-wheel jumper advances the quarter-snail driver and the minute-snail 8° and the minute-counter arm drops. Now the snail has advanced 15° and the articulated arbor has advanced to the position shown in Figure 132c. So the minute-counter arm drops onto the minute-snail in the position corresponding to 2 minutes of the next quarter.

Second, the minute-counter drop spring, Figure 130 f' (page 65), is stronger than the star-wheel jumper spring and it forces the minute-snail to rotate 8° clockwise, retarding it and moving the articulated arbor back to the position in Figure 132b. The minute-counter is now in the correct position to strike 0 minutes. However, the quarter-snail driver has also rotated clockwise and has brought the star-wheel and quarter-snail back to the position shown in Figure 109 (page 59), with the snail advanced only 7° .

Ideally the quarter-snail should advance 15° , as explained in Chapter 1 when we examined the corresponding behaviour of the hour-snail in a quarter repeater. However, a smaller advance will work, provided that the snail arm is made narrower on its trailing edge so that it will not hit the previous step on the snail. In addition, as explained in the discussion of Lecoultré's snail at Figure 22 in Chapter 1 (page 12), the arm can be made a bit wider than the required 6° (7° less 1° for freedom) if the snail is rotated a little relative to the star-wheel. Clearly the best compromise is if the articulated arbor provides 7.5° of freedom and the snail advances 7.5° .

An advance of 15° is impossible. If the articulated arbor had 15° of freedom then the quarter-snail would be both advanced and retarded 15° , bringing it back too far and 11 hours, 1 quarter 0 minutes would strike at 11 hours 30 minutes. Alternatively, if the quarter-snail driver was made narrow enough to allow the snail to advance 15° , then it would be impossible to set the hands backward, because the snail driver could not turn the star-wheel back far enough for the jumper to pass over the tip of a ray. Thus dividing the freedom equally between the articulated arbor and the snail driver is necessary.

The action of the hour-snail must be the same, and the design of it and the hour-snail driver, and the diameter of the winding-rack pin, Figure 104 a (page 58), must be the same as the corresponding parts of the quarter counting mechanism. So at the change of any quarter the repeater strikes correctly. However, when the hour changes both the quarter-snail star-wheel jumper and the hour-snail star-wheel jumper are active. So the minute-counter drop spring f' , Figure 130 (page 65), must be stronger than the combined force of both jumper springs so that it can retard the minute-snail to the correct position to strike zero minutes.

This creates a problem. At 12 hours 30 minutes the quarter-snail jumper-spring b' *on its own* must be able to advance the minute-snail. But to do this it must overcome the friction between the minute-snail and the minute-counter arm as the transfer wheel slides under the arm, Figure 131. If it could not, when activated the repeater would strike 12 hours, 2 quarters (because the snail has advanced 7°) and 14 minutes! Clearly the friction between the minute-snail and the minute-counter arm must be kept to an absolute minimum.

When the repeater has an isolator, the above problem does not occur, because the minute-counter arm is held away from the minute-snail unless the repeater is activated. Also the quarter and hour snails advance 15° and the minute-snail advances to the position corresponding to 2 minutes of the next quarter. The mechanism stays in this state until the motion-work catches up or the repeater is activated; if it is activated, the minute-counter arm will force the minute-snail back to register the correct number of minutes.

12 hours 29 minutes

We will now examine what happens when we activate the repeater between 12h 29m 53s and 12h 29m 59s. We expect the repeater to strike 12 hours 1 quarter and 14 minutes. This time is chosen because the next step of the quarter-snail is *smaller* in diameter and the quarter snail can *advance* during hour striking.

The IWC repeater takes about 20 seconds to strike 12 hours, 3 quarters and 14 minutes. The hours take about 9 seconds, the quarters about 3 seconds and the minutes about 7 seconds. The missing second is taken up by the 2 short periods of silence between each group. (Thus hour and quarter striking take about 12.5 seconds, and so 15 seconds or 1° of freedom is sufficient.)

Because quarter striking occupies the same amount of time irrespective of the number of quarters to be struck, the time to strike is about $\frac{9}{12}h + \frac{1}{2} + 3 + \frac{1}{2} + \frac{7}{14}m$ seconds, when the repeater is activated at h hours, any number of quarters and m minutes; the additional two half-seconds are for the time delay between the hour and quarter, and quarter and minute striking. As we are concerned with striking immediately before the change of quarter, when 14 minutes strike, the time to strike is $\frac{9}{12}h + 11$ seconds. Thus, striking at 12h 29m takes the same time as striking at 12h 59m.

Before examining what occurs, we must remember two things that happen when the repeater is activated. First, the quarter-counting piece is released so that it can drop onto the quarter-snail. It remains *free*, held in place by its drop spring, until after the hours strike, when the gathering pallet r' (Figure 110, page 59) starts raising it to strike the quarters.

The IWC Minute Repeater

Second, the minute-rack $X-N'$ (Figure 115, page 61) is also released and drops onto the minute-counting piece. It remains *free*, held in place by its drop spring, until after the quarters strike, when the minute synchroniser locks the minute-driver and the minute-pinion together (Figures 119 to 123, page 62 on). Thus, during hour striking all three pieces (the quarter-counting piece, minute-rack and minute-counting piece) are free and held in place by drop springs.

When the repeater is activated at about 12h 29m 59s:

- (a) First, the quarter-snail is being driven by the quarter-snail driver and the minute-snail is held in its *retarded* position (Figure 132b). The minute-counter arm is resting on the tip of a minute-snail arm and the quarter-counting arm is resting on the first-quarter step of the quarter-snail. The repeater runs and strikes some of the 12 hours before the motion-work reaches 12 hours 30 minutes.
- (b) At 12h 30m 0s, while the repeater is still striking the hours, the quarter-snail star-wheel is advanced by its jumper. In this case the step 2 of the quarter-snail *is smaller in diameter* than the step 1. (The steps are numbered 0 to 3 corresponding with the quarters.) At the same time, the *quarter-counting piece is free*, and so *the quarter-snail is advanced and the quarter-counting piece drops into step 2*.

The ray of the quarter-snail star-wheel behind the quarter-snail driver advances the driver and so advances the minute-snail 8° . Consequently, the minute-counter is no longer supported by the minute-snail and tries to drop in the space between two minute-snail arms to register zero minutes.

So, while the hours are striking the mechanism appears to advance to the position for striking 2 quarters and zero minutes.

Before we can understand the consequences of this, we need to know a bit more about the springs involved.

First, consider the ordinary behaviour at other times. When the repeater is activated at 5 minutes (Figure 115, page 61) the minute rack drops onto the minute-counter T . At this point both the minute-rack and the minute-counter are free and held in position by their drop-springs. Consequently, the minute-counter drop-spring f' *must be stronger* than the minute-rack drop-spring; if it were not, the minute-rack would push the minute-counter outward (clockwise) and the wrong number of minutes would be struck.

So, if the minute-snail was to advance so that it no longer supported the minute-counter c' , then the minute-counter would try raise the minute-rack, and if it succeeded then 14 minutes would strike with great rapidity! In the above situation this would occur while the hours are striking. (If the minute-rack was returned to its at-rest position, it would move the hammer-pallets out of mesh and striking would cease. However, this cannot happen because it requires the minute-rack minute-counter arm, Figure 115 c , to be lifted away from the minute-counter.)

However, for the minute-rack to rise it must trip the small-hammer pallet, and so the minute-counter drop-spring has to overcome the small-hammer strike-spring as well as the minute-rack drop-spring if it is to move the minute-rack. This is not possible because the hammer spring has to be quite strong to drop the hammer rapidly when striking. And so the minute-counter drop-spring does not have enough strength to rotate the minute-rack *and* trip the hammer. The minute-counter piece arm c' will remain suspended above the minute-snail and 14 minutes will not strike rapidly. (The position of the watch and hence the effect of gravity also needs to be considered. In some positions gravity adds to the force of a spring and in other positions it will decrease the effect.)

And so, to finish the explanation:

- (c) After the hours have struck, because the quarter-snail has successfully advanced, 2 quarters strike followed by 14 minutes. So the repeater incorrectly strikes 12 hours 2 quarters 14 minutes at 12 hours 29 minutes.

This error will occur for every quarter change except for the change from 3 to zero quarters (at 59 minutes 59 seconds) when the quarter-counting piece blocks the advance of the quarter-snail.

In reality, it is very unlikely that this error will be heard, because the repeater has to be activated within a few seconds of the change of quarters so that the state transition occurs before the quarters start striking. For example, at 1 hour 29 minutes the repeater has to be activated less than 1 second before the quarter changes, after 1h 14m 59s. This would be almost impossible to do other than by accident. Also, if it was heard, the owner would either not know, because he was not looking at the hands at the time, or he would activate the repeater again to check and hear it strike correctly. However, despite being unlikely to happen, incorrect striking is a major fault.

There are two ways of overcoming this problem.

The first method, which IWC normally uses, relies on friction. The quarter-counting piece drop-spring f (Figure 110, page 59) is adjusted so that the friction exerted by the quarter-counting piece on the quarter-snail is about the same as or more than the force exerted by the quarter-snail star-wheel jumper-spring, Figure 109 b' . In which case the quarter-snail will not be advanced by the star-wheel and striking will be correct. The quarter-snail will advance slowly while it is

The IWC Minute Repeater

being driven by the quarter-snail driver and the friction must be kept as weak as practicable to minimise the effect on the motion-work and hence the rate of the watch.

This method of ensuring correct striking is not reliable because jolts, the position of the watch (and hence the effects of gravity) and small variations in individual watches can result in incorrect striking. However, it is rare; for example, in a number of tests conducted by Stefan Weeber on his IWC Portuguese watch, the repeater struck incorrectly only once.

The second method for overcoming this fault, which was used in early prototypes, explains why there is a notch in the end of the quarter-counting piece arm. This notch is highlighted in Figure 111 (page 60), but it was not mentioned at that time; however, like everything else, it must have a purpose.

The notch is used in conjunction with the quarter-snail shown in Figure 133, which has corresponding *blocking pieces* protruding from the ends of the steps. Immediately before the end of a quarter, the quarter-counting piece arm can land correctly on the snail. However, if the quarter-snail jumper-spring tries to advance the snail, it will be unable to do so and the quarter-counting piece arm will remain on the correct step. And so the repeater cannot strike incorrectly.

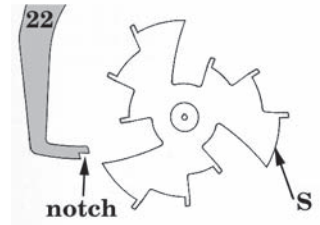

Figure 133

There should be a small amount of freedom between the notch and the blocking pieces. To use the above example, before 12 hours 30 minutes the quarter-snail is being driven by the quarter-snail driver (Figure 108, page 59) and it must be driven up to *at least* 30 minutes. Actually a small allowance needs to be made to ensure correct change of quarters, and, if the snail and star-wheel cannot advance, the driver will continue pushing the quarter-snail for a short time *after* 30 minutes. To do so there needs to be a gap for freedom between the quarter-counting piece arm and the blocking-piece; if it cannot do so, because of the blocking pieces, the motion-work and going train will be impeded.

Unfortunately, because the blocking pieces are so small (they are only about 0.13mm wide) it is not possible to provide sufficient freedom to cover the situation where the hands are set forward while the repeater is striking: “The drawback of this design was that the user had four opportunities instead of one to jam or break the repeater when adjusting the hands while the repeater was running.” (Private communications from IWC, 16 September 2008 and 10 January 2009.) That is, if the owner of a repeater tried to set the hands forward after the repeater had been activated, the quarter-snail driver will attempt to rotate the quarter-snail with the quarter-counting piece arm in contact with a blocking piece, and the arm and/or the blocking piece will be bent or broken.

As a consequence, “it was therefore decided to implement the [first method described above] which strikes correctly 99.5% of the time but offers a margin against operating errors. For the connoisseur, who would prefer to eliminate this 0.5% of short fall but at the same time knows how to handle his complication, we can install the original quarter snail [Figure 133]. So far, experience has justified this decision; we have received no negative feedback at all commenting on this ‘missing 0.5% of performance’, but we know of some watches which have been jammed or broken because of adjusting the hands while the quarter-counting piece blocks the advance of the quarter snail between 3 quarters and no quarters. This can happen when owners or their friends do not fully understand the complexity of the minute repeater, or when they are passionately trying all watch functions almost at the same time.” (Private communication from IWC, 16 September 2008.)

12 hours 59 minutes

The extreme position, when striking changes from 12 hours, 3 quarters and 14 minutes to 1 hour exactly, has been explained. Because both the hour and quarter snails use star wheels and jumpers their freedom and accuracy is simple (page 66). And the minute snail behaviour has been explained above.

Hand setting

As with other repeaters, the hands can be set forward, when the repeater is not activated, this simply being a more rapid but identical movement to that which occurs during normal running of the watch.

Setting the hands backward in most repeaters depends on the action of the hour-snail driver attached to the quarter-snail or its freedom piece. As we have seen, if the hands are set back to later than 57½ minutes the repeater will sound the wrong time. In contrast, Stogden’s repeater will function correctly provided there is no play between the canon pinion’s lantern pinion and the intermediate wheel which controls the hour-snail.

But in all cases it is preferable, if possible, to set the hands at a time when the hour and quarter do not change, or to set them back too far and then set them forwards to the correct time.

The IWC Minute Repeater

The quarter-snail and hour-snail drivers in the IWC repeater are designed so that they function correctly when turned backwards. This accounts for their asymmetric shape, as shown in Figures 108 and 109. Because of the 7° of freedom, the back face of the driver must penetrate further into the space between two star-wheel rays in order for it to turn the star-wheel the necessary 15° .

However, there is the same problem with the behaviour of the snails at hour and quarter changes. For example, assume the repeater has not been activated and the minute-counter arm is being held away from the minute-snail by the isolator. At each quarter change, the quarter-snail star-wheel and jumper will have advanced the quarter-snail, and the minute-snail will be held in its advanced position, so ensuring correct striking of the next quarter. If the hands are now turned backward from, say, 15 minutes to 13 minutes, then the back of the quarter-snail driver will push against the star-wheel and rotate the quarter-snail backward. This will continue until the star-wheel jumps and the quarter-snail flips back to the previous quarter, which will happen at 11 minutes 15 seconds. So if the repeater is activated at 13 minutes it will incorrectly sound 0 minutes instead of 13 minutes.

And the same problem occurs with the hour-snail, so that at 3 hours 13 minutes the repeater will strike 4 hours 0 minutes.

The IWC repeater is different because of the movement of the minute-counter.

In the early repeaters with an isolator, the minute-counter is normally disengaged from the minute-snail, as in Figure 129, and the hands can be set backwards.

Hand setting with the repeaters without an isolator is different because the minute-counter is always in contact with the minute-snail. Also, when there is an isolator the minute-counter is resting on the minute-snail immediately after the repeater has been activated, as in Figure 130, until it is raised up at the end of the quarter. Both cases are the same and are considered together.

When the hands are set backward within a quarter, the minute-counter simply slides down the face of a minute-snail arm to the correct position. However, if the hands are set backward to a previous quarter, as in Figure 134, the minute-snail S' rotates clockwise lifting the minute-counter out of the way; which it can do, because the minute-counter arm c' is pivoted and only held in place by the spring t . (If this were not the case, the minute-counter arm c' would jam against the minute-snail, the hands could not be set back further and the motion-work would slip or the going train stop.)

In any case, if the repeater is activated at this point it must strike incorrectly. Indeed, during successive activations from the position in Figure 134, the anti-clockwise rotation of the minute-snail will cause the repeater will strike backwards, from about 13 minutes to zero minutes!

The hands can be set backward provided they are set back far enough for the minute-counter arm c' to drop down, and then set forward to the correct time.

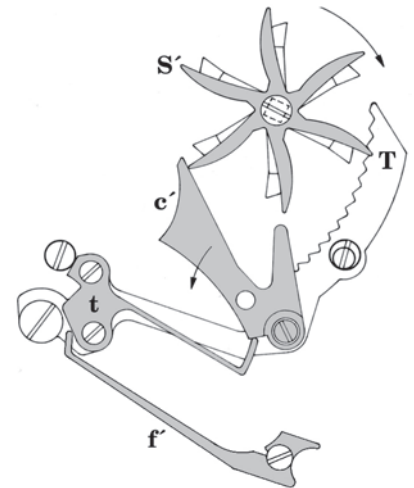

Figure 134

Chapter 6: The Decimal Repeater

Time units

The minute repeaters we have examined can be described generally as repeaters that strike *something* after the last quarter. The illustrations happen to show minutes, but that is not the only possibility. If the minute snail is replaced by a snail with a different number of steps, and the counting and striking mechanisms are modified to have an appropriate number of teeth (one less than the number of steps on the snail), then anything can be struck.

If the snail has 2 steps we have a half-quarter repeater. In Figure 59 of Chapter 3 (page 32), the 14 teeth N' are replaced by a single tooth and the gathering-pallet r' can be simplified to act in one or two positions. The same changes are made in Figure 63 (page 34).

If the snail has 3 steps we have a five-minute repeater. And there is nothing preventing us having a snail with 5 steps, when we would have a three-minute repeater.

Indeed, all of the hour, quarter and minute snails could be replaced by snails that count other time units, the only problem being that people would have some difficulty understanding the sounds produced. So, although particular repeater mechanisms have been described, they are only common examples. Underlying all of them are the same principles of counting, striking, all-or-nothing and freedom mechanisms. And these mechanisms can be adapted to count in different ways. But most of the other ways of counting are illogical and serve no sensible, let alone useful, purpose.

One silly example is a repeater based on a unit of 80 seconds. It would chime the hours, the number of 12 minute intervals (0 to 4) and the number of 1 minute 20 second intervals (0 to 8). Many other combinations are feasible and logic is not necessarily important. Indeed, for at least 280 years watchmakers have been constructing $7\frac{1}{2}$ minute repeaters, commonly called half-quarter repeaters. This rather odd design could be extended to be a half-minute repeater, by adding a half-minute snail with 8 arms, each having 15 steps.

The decimal repeater

However, one method of counting and striking is not only sensible, it is vastly superior to all the minute repeaters we have examined; and that is the *decimal repeater*.

Consider a normal minute repeater set to strike at 5h 27m. The sounds we hear are 5 low notes, 1 high-low double note and 12 high notes. It is clearly after 5 o'clock, but to know how many minutes after we have to add 15 minutes for one quarter to 12 minutes before we know that the time is 5h 27m. This is not simple because such a repeater combines two completely different ways of "telling" the time. We are happy to say "a quarter past" and "a quarter to" when stating the time to the nearest quarter hour, and a normal quarter repeater serves this function very well. But we *do not* say "a quarter past and 12 minutes" when needing to state the time to the nearest minute. Anyone who did so would be regarded as perverse, as would a person who announced the time to be 5 half-quarters past six.

In reality, when asked the time to the nearest minute we use *decimal* numbers. We say "5 hours 27 minutes". Or, to put it another way, we say "5 hours, 20, 7 minutes". And this is what all good minute repeaters *should* strike. That is, they should be *decimal* repeaters. (We also commonly say "12 to 6" for "5 hours, 48 minutes". However the sounds of a repeater that counts differently before and after the half hour would be ambiguous and very confusing; consequently, it is one of the many designs that are possible but pointless. In principle, such a repeater has an hour-snail that is aligned with the half-hours instead of the full hours. And the quarter and minute snails are shaped so that the number of quarters and minutes decrease past the half-hour; the steps are reversed.)

A decimal repeater is a very simple variation of the minute repeaters we have examined. First, the quarter-snail with its four steps is replaced by a *ten-minute snail* with six steps; this sounds the number of ten-minute intervals since the last hour, from 0 to 5. Second, the minute-snail is changed to have six arms, each with 10 steps corresponding to a 10-minute interval. Consequently, at 5h 27m it sounds 5 low notes, 2 double notes, and 7 high notes for two-twenty-seven, and the time is immediately understood by the wearer of the watch.

A reverse history

I have always been frustrated by three things. First, the striking of normal minute repeaters is awkward and difficult to interpret. Second, the repeater mechanism is hidden under the dial and it is not possible to watch it while it is striking. And third, the repeater slide is always on the left side of wrist watches, where it is inconvenient to operate.

In 2007, as a result of writing the above explanation of time units, I "invented" my ideal repeater. It would use a decimal counting mechanism, the dial would be replaced by a transparent sapphire plate so that the mechanism is

The Decimal Repeater

exposed, and the slide and crown would be reversed, placing the slide on the right-hand side of the wrist watch so that it is easy to use. Such a repeater would be just about perfect.

When it comes to inventions, only the first person to have a particular idea gets the credit for it. So I was somewhat disappointed when, not long after, I found that in 2005 Kari Voutilainen had “devised a repeating mechanism which sounds the hours, the ten minute interval and then the exact minutes. This unusual and extraordinary watch is the first repeater of this kind”. I was two years too late! And, even though I had worked out the design by myself, coming second does not earn any recognition.

Kari Voutilainen has made four decimal repeaters which are based on ebauches made by LeCoultre. (LeCoultre used to make ebauches which were not finished; parts were rough machined and there were no jewels, escapement or balance, etc. These ebauches have been used by many companies, including Audemars Piguet and Patek Philippe.) The one shown in Figure 135 is a normal minute repeater where the minute-snail has been replaced by a 6-arm decimal minute snail, and the quarter-snail has been replaced by a 6-step ten-minute snail. The strike racks have also been replaced appropriately.



Figure 135

Since then, Audemars Piguet have released a decimal repeater which is also described as having a “unique striking complication”; it is limited to about 20 pieces. And so only a few very rich people will have the pleasure of owning a decimal repeater and the rest of us will have to bemoan the fact that they were not manufactured in large numbers in the past, especially as other watchmakers are sticking to the old, illogical designs for minute repeaters that have been made for nearly 300 years. (Actually, this is not surprising. Modern mechanical watches are primarily status symbols and/or jewellery, and their ability to show or sound the time comes a very distant second. So what a repeater chimes is almost irrelevant.)

That should have been the end of the matter. But some months later I was reading Hans Staeger’s book *100 years of precision timekeepers* (published in 1997) when I noticed a fascinating entry: “6 x 10 minutes and minute repetition, gold/enamel case, made for King George III”. And this referred to a watch made by John Arnold in 1768! Staeger provided a reference to Catherine Cardinal’s book *Watchmaking in History, Art and Science, Masterpieces in the Musée International d’Horlogerie* (published in 1984). There I found an excellent photograph of the case and the movement’s top plate, but no photograph of the repeater mechanism. The relevant parts of Cardinal’s description are: “It was manufactured about 1768 for George III who offered it to one of his equerries, Colonel Price. ... Arnold also included in this watch a second indicator at the centre and an unusual type of minute repeater. The watch strikes the hours, fractions of ten minutes then the extra minutes”. After this I found the watch is also mentioned in Vaudrey Mercer *John Arnold and Son* (published in 1975), but at the time I read that book I was not interested in repeaters and so I missed the significance of it.

In addition, Arnold’s watch is signed “John Arnold Londini fecit N° 1”. Arnold made several watches with the serial number 1 on them and it is probable that this is the first (and only?) decimal repeater that he made. Actually it might be the only *minute* repeater he made, because there are no other minute repeaters in Staeger’s comprehensive lists of Arnold watches. However, for reasons I will explain later, it is likely he did make at least two minute repeaters striking quarters.

There matters rested for several months until I got a copy of *The English watch 1585-1970* by Camerer Cuss (published in 2008), in which I found reference to another decimal repeater, made by Thomas Mudge circa 1766 (Plate 137 of that

The Decimal Repeater

book). Unfortunately the repeater mechanism is not shown and Camerer Cuss was unable to provide me with any more information about it. However, Camerer Cuss also provided a reference to a third decimal repeater signed by John Ellicott circa 1747, described by Arndt Simon in *A pre-1750 minute repeating watch*, *Antiquarian Horology*, Autumn 1991, pages 525-530).

So Kari Voutilainen, Audemars Piguet and I are about 260 years too late! If we had known where to look we would have realised this some time between 1975 and 1997.

The idea of a decimal repeater is simple, but there are two aspects of them which are fascinating. First, the only early examples I know of are English and based on Stogden's mechanism. And second, since then the idea has been completely ignored; I have found not one mention of it being used between 1768 and the present, and I am unaware of any patent for such a watch.

Ellicott, Arnold and Breguet

The two decimal repeaters for which we have information are shown in Figures 146 (page 81) and 155 (page 85).

The earlier, Ellicott No. 2844 circa 1747 (see Figure 155), is clearly based on Stogden's repeater with a minute rack superimposed. (The most obvious features to show a repeater is based on Stogden's design are the all-or-nothing rocker and the geared hour-snail.) The owner Arndt Simon suggests that this repeater may have been made by Thomas Mudge for Ellicott. In support of this, Camerer Cuss notes that the Mudge watch illustrated in his book is "virtually identical" to Ellicott's repeater.

Arnold's repeater (see Figure 146) was made some 21 years later and is also based on Stogden's repeater, but there is no obvious minute striking mechanism.

Although it is clear that these repeaters are based on Stogden's design, it is impossible to understand how the minute striking mechanism works from such photographs. Not only is it very difficult to determine the three-dimensional layout, but too much of the mechanism is hidden by other parts.

However I was rescued by Breguet. As I have mentioned in Chapter 4, I am confident that Breguet got the basic design for his watches from examining repeaters made by Arnold. And even though he made important changes, Breguet's repeaters are certainly based on Stogden's design. Stogden invented his repeater in about 1720 and, as far as I am aware, it was never used outside England. However, Arnold used it extensively and Breguet would almost certainly have seen such watches through his contact with Arnold.

Two fascinating pieces of evidence to support this view are two watches signed by Breguet.

Watch number 125⁵/₈₅ is illustrated in the Antiquorum auction catalogue *L'Art de l'Horlogerie en France* lot 166 and reproduced in Figure 136; the same watch is illustrated in the Antiquorum auction catalogue *The Sandberg Watch Collection* lot 182.

Watch number 128⁵/₈₅ is illustrated in *The Art of Breguet* by George Daniels. It appears to be identical to the repeater in Figure 136.

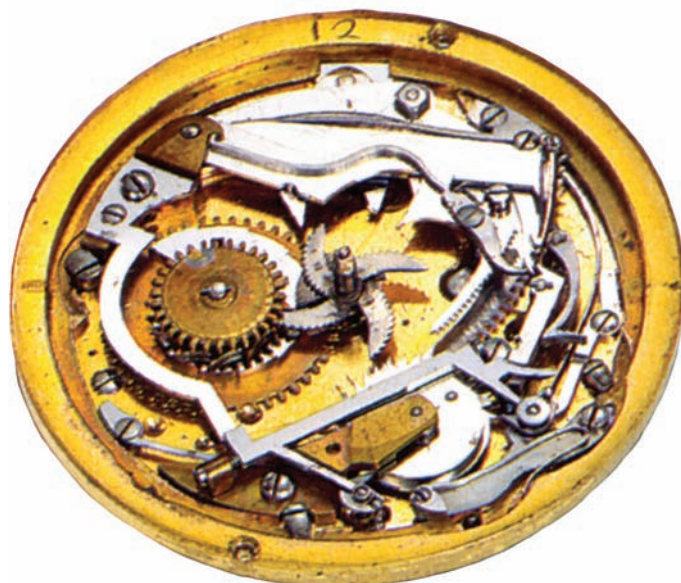

Figure 136

The Decimal Repeater

Both watches were made in 1785, 17 years after Arnold's decimal repeater. These minute repeaters (striking quarters) appear to be almost identical to Arnold's decimal repeater and Daniels believes the repeater work, or indeed the complete watches, must have been made in England. So it is hard to avoid the possibility that all three were made by the same person, quite probably Arnold himself. (However, other makers produced such repeaters, and Antiquorum *The Art of British Horology* illustrates an identical repeater made by Josiah Emery about 1775.) It appears that Breguet did not make a decimal repeater. He did make ten-minute repeaters, but he did not add minute striking to them, and all his minute repeaters strike quarters.

Unfortunately the photographs in *The Art of Breguet* are very poor and that in *L'Art de l'Horlogerie en France* is too small to show enough detail. Also the descriptions by Daniels are obscure and, as I eventually discovered, inadequate. However there are drawings of a minute repeater mechanism and, although they are incomplete and hard to comprehend, they provide enough information to understand the mechanism.

Breguet's own minute repeater mechanism is significantly different from the watch in Figure 136 and it is his adaptation of the Stogden design. Like his quarter and half-quarter repeaters described in Chapter 4, it has the hour-snail controlled by a star-wheel instead of geared to the canon pinion, and it uses a spring to control the height of the hammer pallets instead of a rocking bar. Such repeaters are illustrated by Daniels, but the photographs of them are inadequate and details of the mechanism cannot be seen. (See, for example, *The Art of Breguet* illustrations 81, 82, 98, 211, 241, 242 and 243.) Drawings of the mechanism appear in the Antiquorum auction catalogue *The Art of Breguet*, but unfortunately none of the watches in that catalogue have a minute repeater of the type illustrated.

Because I do not have drawings of Ellicott's and Arnold's decimal repeaters to support my explanation of their actions, I will describe these mechanisms in reverse order, starting with Breguet's minute repeater. Once we understand that mechanism it is easier to explain the other two.

Breguet's minute repeater

As we know how the half-quarter repeaters of Stogden and Breguet work, I will begin with the strike racks, the hammer pallets and the small all-or-nothing piece, Figure 137.

This repeater has two hammers. The large hammer, operated by the pallet *Q*, strikes the hours and quarters on the case, and the small hammer, operated by pallet *O*, strikes the minutes on a gong; the double strikes for the quarters are only distinguished from the hour strikes by the short period of silence separating them. Corresponding to the hammers there are two strike racks. Rack *G* strikes the hours and quarters and rack *G'* strikes the minutes. The spring *e* (yellow) replaces the rocker used in Stogden's repeater and the two hammer pallets are linked together so that the spring will act on both.

(In previous chapters I have said that gongs were probably invented around 1790 and Crespe, in his book *Essay on repeater watches*, claims he invented them. In *The art of Breguet*, George Daniels says Breguet invented the gong before 1783 and notes that "Breguet's gongs give a dull, unmusical sound which may be partly accounted for by his increasing deafness ... The earliest make the most pathetic and unmusical noise". So Breguet's gongs merely distinguished one dull thud from another dull thud, whereas Crespe's were carefully chosen to produce musical notes. Daniels' suggestion that Breguet's gongs were a consequence of his deafness is not credible; Breguet did not work alone and if he had wanted musical sounds he could have easily got one of his workers to tune them. Thus Breguet's "gongs" are not gongs as we know them and Crespe's claim seems to be valid.)

When the repeater is activated, the small all-or-nothing piece, Figure 137 *z* (green), is withdrawn from under the spring *e* and the two pallets, which are linked together (yellow), drop so that pallet *Q* is on the same level as the hour-quarter strike rack *G*, but pallet *O* is below the minute strike rack *G'*. The small all-or-nothing piece *z* is actually two pieces, one above the other. It is necessary that the pallets are raised twice during striking, once to terminate quarter striking and again to terminate minute striking. To do this, two wedges have to be pushed under the spring *e*. (Figure 137 is a bit like an M. C. Escher drawing with the small all-or-nothing piece appearing to pass through the strike racks! This unfortunate illusion is because the artist has cut away the racks to show the structure of the small all-or-nothing piece.)

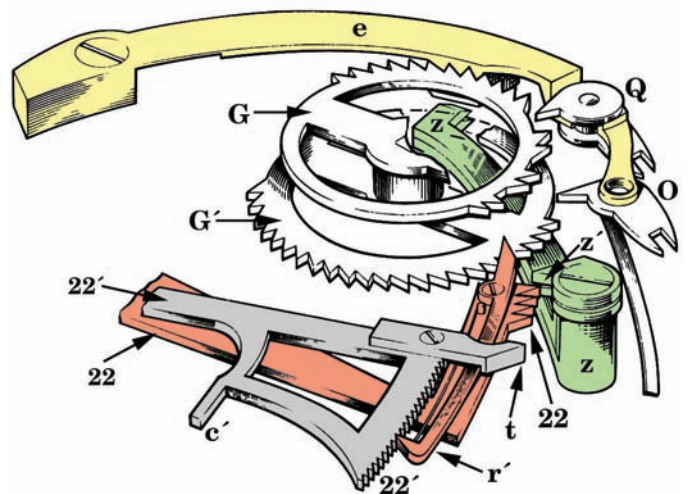

Figure 137

The Decimal Repeater

Hour and quarter striking proceed as in a normal Stogden repeater. As soon as the winding rack reaches the quarter-counting piece **22** (red) and starts lifting it, the teeth **22** rotate the bottom pallet z' of the small all-or-nothing piece clockwise, forcing one wedge under e . This raises the pallet **Q** above the strike-rack **G** and quarter striking ceases. At the same time, the pallet **O** is lifted to the same level as strike-rack **G'** and minute striking can commence. Thus the method of controlling quarter striking is exactly the same as in an ordinary Stogden repeater.

Minute striking uses a mechanism which is similar in principle to that in the modern simplified minute repeater (described at Figure 64 in Chapter 3, page 35) where the teeth **22'** (grey) count the number of minutes. A minute-counting piece gathering pallet r' (red) is mounted on the quarter-counting piece and meshes with one of the minute-counting teeth **22'**, so the quarter-counting piece raises the minute-counting piece while the minutes are struck by the rack **G'**. After the minutes have sounded, the trip t meets the top pallet z' of the small all-or-nothing piece, rotating it clockwise and forcing the second wedge under e . This raises the pallets **Q** and **O** a second time so that the pallet **O** is lifted above strike-rack **G'** and minute striking ceases. The quarter-counting piece, the minute-counting piece and the strike racks then rotate together silently to the at-rest position.

In Figure 137 the position and number of teeth on the minute strike-rack **G'** appear to be wrong. First there are 23 teeth, but only 14 are required to strike the minutes! Second, some of the teeth appear to be vertically below the quarter strike teeth on the strike rack **G**. But before explaining why we need to understand more of the mechanism.

From Figure 138 it can be seen that the mechanism is the same as Stogden's repeater with the addition of the minute-counting piece **B-22'** (light grey) and the piece **8'** (yellow) which will be discussed later. The only other difference is that the *small all-or-nothing piece lock* m' is an arm on the winding rack **C** (dark grey) instead of a block on the quarter-counting teeth **22** (red). This change is because there are two small all-or-nothing pieces and both have to be locked to ensure the mechanism cannot be jammed. Although a block on the quarter-counting teeth would prevent the bottom pallet z' from obstructing activation, it has no effect on the top pallet which can still obstruct the minute-counting piece.

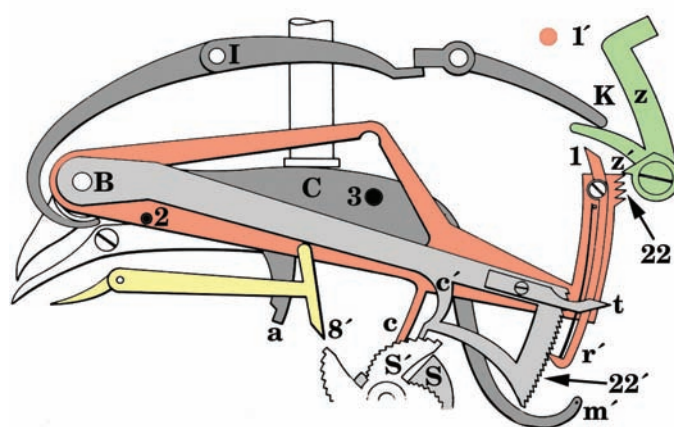

Figure 138

Unfortunately it seems the illustrator did not understand what he was drawing and Figures 137 and 138 are wrong. First, the minute-snail has only 14 steps instead of the necessary 15 steps for 0 to 14 minutes. And second, according to the positions of the snail arms the repeater is about to strike 0 quarters and 2 minutes. However, in Figure 138 the positions of the quarter and minute counting piece will cause 0 quarters to strike followed by about 21 minutes! Figure 137 is a little better, but minute striking will still be wrong.

As I am not a competent illustrator I cannot provide correct drawings of the mechanism. Instead I will use simple diagrams to show the principles correctly. But before explaining how minute striking works we need to know three things:

First, the minute-counting teeth **22'** are ratchet teeth so that the gathering-pallet r' can raise the minute-counting piece. Now assume the repeater is at rest with the minute-counting piece held by r' in the position shown in Figure 138. If the repeater is activated and the quarter-snail arm c lands on the quarter-snail *before* the minute-snail arm c' has reached the minute-snail, the gathering-pallet r' will prevent the minute-counting piece dropping further and the arm c' will be held above the minute-snail, resulting in incorrect striking. In the reverse case, when the minute-snail arm c' lands on the minute-snail before the quarter-snail arm c lands on the quarter-snail, the quarter-counting piece will continue to drop with the gathering pallet sliding over the ratchet teeth.

To prevent the problem described above and allow the minute-counting piece to drop correctly, when the quarter-counting piece is raised to its at-rest position, the end **I** of the gathering-pallet meets the pin **I'**, which rotates the gathering-pallet out of mesh with the teeth **22'** and the minute-counting piece drops to its lowest position. Then, when the repeater is activated, the minute-snail arm c' will always land on the minute-snail before the quarter-snail arm c lands on the quarter-snail and correct counting of the minutes and quarters is assured.

However, when the repeater is at-rest there is nothing controlling the position of the minute-counting piece, which is completely free, and it can immediately drop onto the minute snail. This would be disastrous because, as the going train advances the motion-work, the minute-counting piece will block the rotation of the minute-snail and the mechanism would jam permanently. To avoid this there is a stop, pin **2** Figure 138, mounted on the quarter-counting piece. This pin allows the minute-counting piece to drop far enough to ensure correct counting of the minutes and no further.

The Decimal Repeater

The second thing we need to know is that the distance from one tooth to the next of the quarter-counting teeth **22** (red) is in exact proportion to the height of the quarter-snail steps; that is, when the snail arm *c* moves from one step to the next, one of the counting teeth passes the small all-or-nothing trip *z'* (green). And the distance from one pair of quarter-strike teeth to the next pair on the strike-rack **G** is in exactly the same proportion.

Likewise, the distance from one tooth to the next on the minute-counting teeth **22'** is in exact proportion to the height of the minute-snail steps. And the distance from one minute-strike tooth to the next on the minute strike-rack **G'** is in exactly the same proportion.

Third, the two strike racks **G** and **G'** are aligned so that some of the minute strike teeth are “covered” by the quarter strike teeth, and in Figure 137 it appears that 6 minute strike teeth are vertically below the three pairs of quarter strike teeth. That is, while the quarter strike teeth are passing the hammer pallet, the first 6 minute strike teeth are passing the pallet. If the one hammer pallet was used for all striking then the drawing would be correct. But because the hammer pallet **O**, used for minute striking, is some distance from the hour-quarter hammer pallet **Q**, the minute rack must be offset by the same distance.

The number of minute strike teeth covered by the quarter strike teeth can vary from one repeater to another and 3, 6 or 9 might be covered.

It is this feature that dictates the number of teeth on the minute strike rack **G'**, which has 17 (14 + 3), 20 (14 + 6) or 23 (14 + 9) teeth. Corresponding to this, the minute-counting piece will have one more tooth; 18, 21 or 24 teeth. (There are 22 count teeth in Figure 138 and probably 24 in Figure 137; also the trip *t* is different in the two illustrations. So this repeater might have 9 teeth covered by the quarter striking teeth. As I do not know which is correct I have chosen 6 for the following explanation.)

These relationships mean that the height of the steps on the quarter-snail must be in exact proportion to the height of the steps on the minute-snail.

Examples of striking

Now, this is how it works:

Figure 139 shows the two strike racks straightened out; for convenience I have assumed the hammer pallets **Q** and **O** are superimposed. The first 6 teeth of the minute strike-rack **G'** are covered by the three pairs of quarter strike teeth on the hour-quarter strike rack **G**. It looks as though tooth 6 on the minute strike-rack is not covered by the quarter strike teeth, but this is because the second tooth of each pair of quarter strike teeth has been moved closer to the preceding tooth to create the double strike.

Figure 140 shows the arrangement of teeth on the two counting pieces. The quarter-counting piece **22** has 4 teeth to control the number of quarters, 0 to 3. The minute counting piece **22'** has 21 teeth. The number of quarters and minutes which are struck depends on the relationship between these two sets of teeth and the small all-or-nothing piece pallets *z'*.

The first case to look at is the full hour when 0 quarters and 0 minutes strike. That is, the hammer pallets must be lifted twice, by both small all-or-nothing piece pallets *z'*, before any strike teeth pass the hammer pallets.

Figure 141 shows this situation. The minute-counting piece snail-arm *c'* has landed on the outermost step of the minute-snail, and the quarter-counting piece has continued dropping as far as it can go, until its snail-arm *c* has landed on the innermost step of the quarter-snail; don't forget that this is based on Stogden's repeater where the action of the quarter-snail is reversed. As it drops it takes the gathering pallet *r'* with it, which slides past the minute-counting piece teeth.

At this point tooth 0 of the quarter-counting teeth **22** must be just under the bottom all-or-nothing pallet *z'*, and the minute-counting trip *t*, which is fixed in alignment with the tooth 1 of the minute-counting teeth **22'**, must be just under the top all-or-nothing pallet *z'*. To do this the gathering pallet *r'* must have lodged under the bottom, 21st tooth of the minute-counting teeth **22'**. Immediately after striking the hours, the quarter-counting piece is raised, lifting the minute-counting piece with it by the gathering pallet *r'*. So the hammer pallets are immediately raised above both strike racks and no quarters or minutes sound.

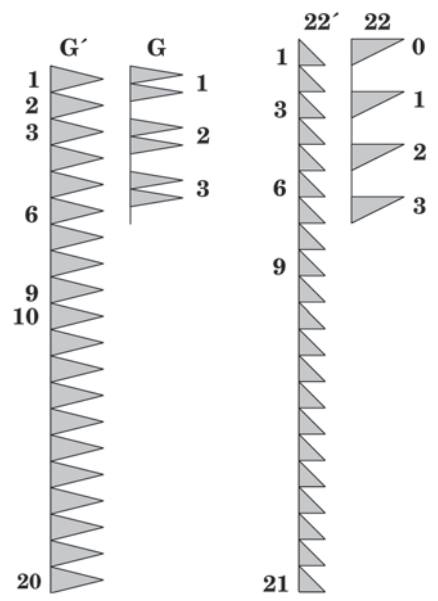

Figure 139

Figure 140

The Decimal Repeater

Figure 142 shows the situation when 3 quarters and 0 minutes strike. Again the minute-counting piece snail-arm c lands on the outermost step of the minute-snail, but now the quarter-counting piece only drops until its snail-arm c has landed on the outermost step of the quarter-snail. And so the gathering pallet r' does not drop as far and lodges under the 15th tooth of the minute-counting teeth $22'$. After striking the hours, there is now a gap between the winding-rack and the quarter-counting piece, and so 3 quarters strike. As soon as the winding-rack reaches the quarter-counting piece and lifts it and the minute-counting piece, the hammer pallets are immediately raised above both strike racks and no minutes sound.

Now consider striking at 0 quarters 2 minutes, the situation that Figure 138 is supposed to represent and shown correctly in Figure 143.

Again the quarter-counting piece drops as far as it can, but the minute-counting piece now drops down 2 steps on the minute-snail. As a result, the gathering pallet r' lodges under the 19th tooth and the trip t is now separated from the small all-or-nothing piece pallet z' by 2 teeth. Now when the repeater strikes, the quarter-counting piece is raised immediately after the hours strike and the *bottom* small all-or-nothing pallet z' lifts the hammer pallets up *once* so that the large hammer pallet Q is above the hour-quarter strike rack G and the small hammer pallet O is level with the minute strike-rack G' .

At this point *none* of the quarter or minute striking teeth on the racks G and G' have passed the hammer pallets Q and O . As the quarter-counting piece continues to rise, the strike racks rotate and the small-hammer pallet O starts striking minutes using the *first* two minute strike teeth, Figure 139 G' , which are directly under the first pair of quarter strike teeth. As this happens, the gathering piece r' lifts the minute-counting piece the distance of 2 teeth, at which point the trip t rotates the *top* all-or-nothing pallet z' which raises the hammer pallets a second time, so that the small-hammer pallet O is now above the minute strike-rack G' , and striking ceases.

After striking, the quarter and minute counting pieces continue to rise until they reach the at-rest position. At which point the gathering pallet r' is disengaged from the minute-counting teeth $22'$ and the minute-counting piece drops to its lowest position, resting on the stop 2 .

Figure 144 shows the situation at 3 quarters and 2 minutes. Again the minute-counting piece snail-arm c lands on the 2 minute step of the minute-snail, but now the quarter-counting piece only drops until its snail-arm c has landed on the outermost step of the quarter-snail. And so the gathering pallet r' does not drop as far and lodges under the 13th tooth of the minute-counting teeth $22'$. After striking the hours, there is now a gap between the winding-rack and the quarter-counting piece, and so 3 quarters strike. As soon as the winding-rack reaches the quarter-counting piece and lifts it and the minute-counting piece, the hammer pallets are immediately raised *once*, above the hour-quarter strike rack. At this point all 6 quarter striking teeth have passed the hammer pallet and, as the minute striking rack rotates with it, the first 6 minute striking teeth have also passed the position of its hammer pallet. As the quarter-counting piece continues to rise, the strike racks rotate and small-hammer

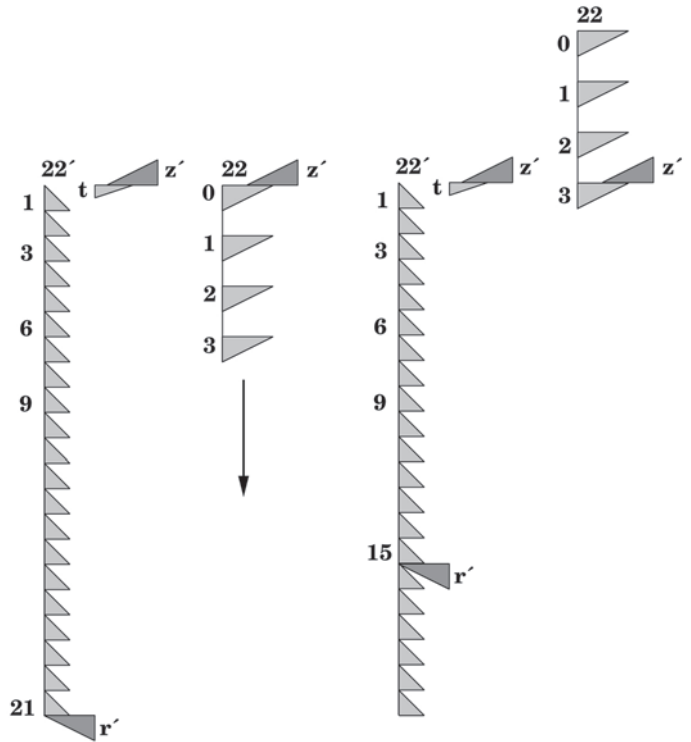

Figure 141

Figure 142

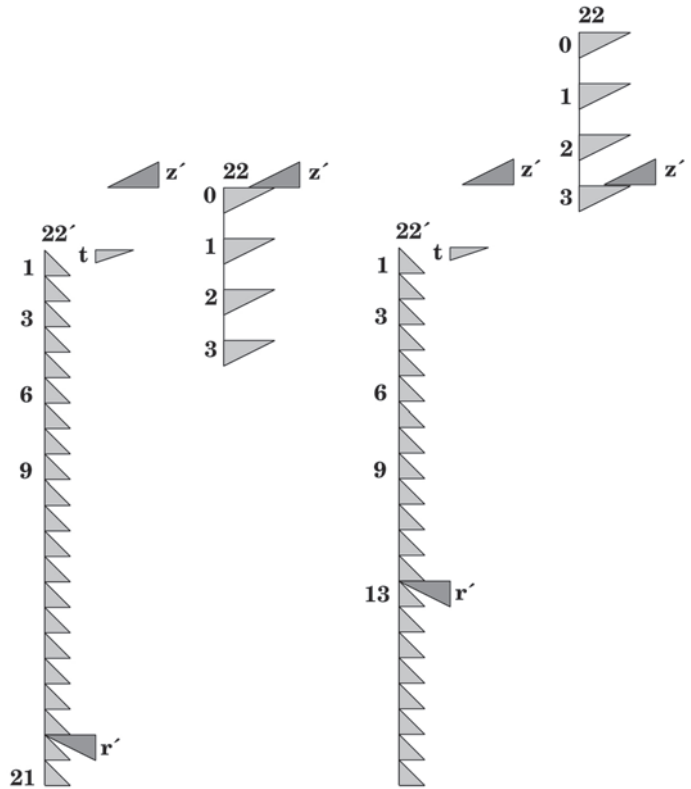

Figure 143

Figure 144

The Decimal Repeater

pallet **O** starts striking minutes using the *seventh* and *eighth* minute strike teeth. As this happens, the gathering piece **r'** lifts the minute-counting piece the distance of 2 teeth, at which point the trip **t** rotates the *top* all-or-nothing pallet **z'** which raises the hammer pallets a second time, so that the small-hammer pallet **O** is now above the minute strike-rack **G'**; and striking ceases.

As the time advances, the minute-counting piece drops further to reach the minute-snail, the trip **t** sits a corresponding number of teeth further from the all-or-nothing pallet **z'**, the gathering pallet meshes with a tooth the same distance from the end of the minute-counting piece, and a corresponding number of minute strike teeth must trip the small-hammer pallet. The extreme of 3 quarters and 14 minutes is shown in Figure 145. At 14 minutes the trip **t** will be 14 teeth away from **z'**, **r'** will be under tooth 1 of **22'** and teeth 7 to 20 of the strike-rack **G'** will be used to strike the minutes.

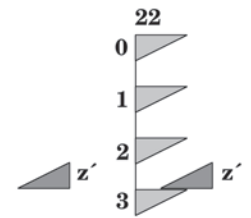

General principles

Rather than give more examples, I will explain the general principle of this mechanism.

Divide the hour into K parts and divide each part into L sub-parts, which are usually minutes; so normally $KL = 60$. And the distance from one tooth to the next on the counting piece **22** covers (is equivalent to) M of the counting teeth **22'**. Then:

- (a) There are K counting teeth on the counting piece **22**, numbered 0 to $K - 1$, and the number of teeth on the counting piece **22'** is

$$N' = M(K - 1) + L$$

For example, Breguet's repeater has $K = 4$, $L = 15$ and $M = 2$, and so $N' = 21$.

- (b) The number of teeth on the strike-rack **G'** is

$$N = N' - 1$$

When the repeater strikes x major units, between 0 and $K - 1$, and y minor units, between 0 and $L - 1$, then:

- (c) The lower all-or-nothing piece pallet **z'** is immediately above tooth x of **22**.

- (d) The gathering pallet **r'** is immediately under tooth

$$R = N' - Mx - y$$

of the counting piece **22'**, $R = 1$ to N' .

- (e) The distance between the trip **t** and the upper all-or-nothing piece pallet **z'** is

$$N' - R - Mx = y$$

- (f) The teeth on the strike-rack **G'** which are used for striking are $Mx + 1$ to $Mx + y$. (This formula only applies when at least one minute is to be struck and one or more teeth are used.)

I have been pedantic and tedious for a good reason: We can determine the different numbers of teeth in any repeater using this mechanism without even examining (or making) the actual watch.

For example, Figures 139 to 145 are based on $K = 4$, $L = 15$ and $M = 2$, and so $N' = 21$ and $N = 20$. But in Figure 137 $N = 23$! This is a perfectly acceptable number because it corresponds to $M = 3$. In which case $N' = 24$, which is probably the number of teeth in Figure 137, allowing for 3 teeth hidden under the trip **t**.

If we look carefully at Figure 136 it is just possible to make out the teeth **22'** and there are 21 of them. Thus for this repeater $M = 2$ and there are 20 teeth on **G'** even though it is impossible to determine these from the photograph.

For my silly 80 second repeater $K = 5$, $L = 9$ and $N' = 21$ when $M = 2$; perfectly feasible although I doubt if anyone would make it. Actually, it is not essential that L is the number of minutes. For example, the half-quarter repeater must have half-minute divisions with $K = 8$ and $L = 15$.

So far I have assumed that the trip **t** must be opposite the first minute counting tooth **22'**, as in Figures 137 and 138. But this need not be the case, and in Figure 136 the minute counting teeth can be seen with the trip **t** above about the 6th tooth. (Several repeaters illustrated by Daniels exhibit the same feature.)

The position of the trip depends on the relative diameters of the quarter and minute snails and the lengths of the snail arms **c** and **c'**; these control how far the quarter and minute counting pieces drop. Also, the position of the all-or-nothing piece pallets **z'** is fixed by the quarter-counting piece; when that piece drops onto the innermost, 0 quarter step its tooth 0 must be just beneath the pallets **z'**. How far the minute-counting piece drops relative to the pallets depends on the diameter of the minute-snail, but the trip always must be just under the pallets when it lands on the outermost 0 minute step. So the trip can be in different locations, but its position does not affect the above description because counting depends on the relative positions of the quarter and minute counting pieces and not the trip.

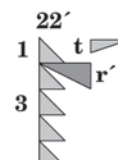

Figure 145

The Decimal Repeater

Strike timing

Strike timing is perfect because there is no delay between the hours and quarters and the quarters and minutes. Except for the simplified quarter repeater and Stogden's repeater, this is the only mechanism that achieves this ideal. All other minute repeaters, except the IWC watch, have an extended period of silence between the hours and quarters, and the IWC watch has an extended period of silence between the quarters and minutes.

Freedom and accuracy

Breguet's minute repeater is the same as his quarter and half-quarter repeaters (described in Chapter 4) with the addition of minute counting and striking. The hour-snail is controlled by a normal star-wheel and the quarter-snail has an integral spring (Figure 96, page 53). Thus hour and quarter snail freedom and accuracy are as described previously.

The addition of the minute-snail, rigidly fixed to the quarter-snail, creates two new problems.

First, the minute snail, unlike the quarter-snail, is normal with the outermost step corresponding to 0 minutes. This means that just before the end of each quarter the minute-counting piece arm, Figure 138 *c'*, might block the canon pinion and hence the going train. However, because the quarter-snail is loose and held in position by a spring, the snail arm will simply retard the minute and quarter snails and there will be no problem other than a slight increase in the load on the going train.

Second, as usual, it is the trailing edge of the minute-snail arm *c'* which determines the minutes. Consequently, unless there is an additional mechanism, some time before, say, 15 minutes the leading edge of *c'* will land on the 0 minute step and incorrectly record 0 instead of 14 minutes. (As you will remember, this problem cannot occur with Stogden's quarter-snail because the steps are reversed.)

Normal minute repeaters overcome both freedom and accuracy by cutting back or removing the 0 minute step and having a separate freedom piece, as explained in Chapter 3 (page 36). However, minute repeaters based on Stogden's design do not use this method. Instead, Breguet's adaptation has a separate *accuracy piece*, Figure 138 *8'*. During the 14th minute of a quarter, the arm of the minute-snail for the next quarter but one is positioned so that the tip of the accuracy piece *8'* will just touch the back of the snail and retard it sufficiently to allow the arm *c'* to drop onto the 14th step of the minute snail. This action also retards the quarter-snail and ensures the right quarter is registered. The accuracy piece will not reach the snail at any time other than the 14th minute because the arm *c'* lands higher up on the snail and the accuracy piece cannot drop far enough.

Arnold's decimal repeater

In August 2008 I contacted the *Musée International d'Horlogerie* in La Chaux-de-Fonds to see if I could find out more about Arnold's repeater. Jean-Michel Piguet, conservator at the Museum, first sent me a photograph of the repeater mechanism, Figure 146, and then he arranged for the watch to be examined. The mechanism was partly disassembled, Figures 147, 148 and 149, but it was found to be in very poor condition, requiring extensive repairs; it has probably suffered in the hands of an incompetent repairer at some time in the past. And so it was decided to leave it in its present condition, and the watch was reassembled. Consequently I was not able to get more information about it and I have to make a few, hopefully inspired, guesses in my explanation.

This repeater uses a standard Stogden mechanism, as described in Chapter 4, with the addition of minute counting and striking as used in Breguet's repeater described above; there are a few important differences which will be discussed below.

Figure 146, the original state of the mechanism, shows the repeater has been activated and it has then jammed.

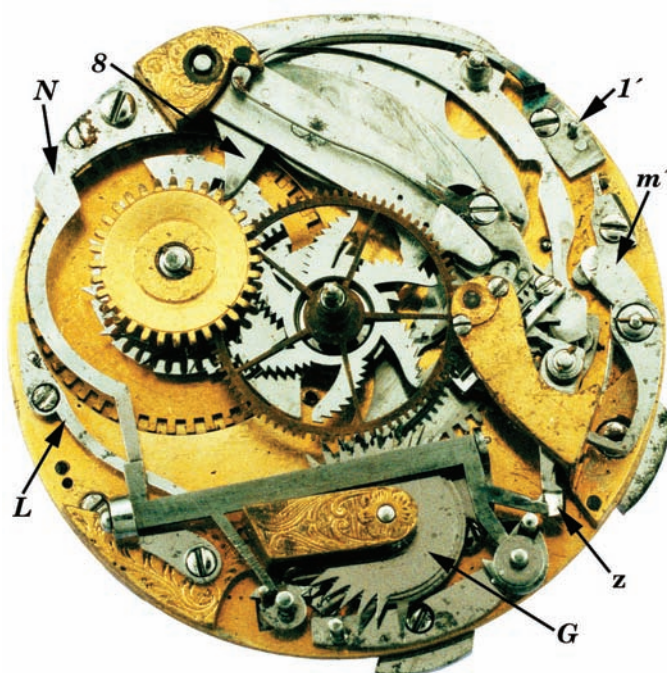

Figure 146

The Decimal Repeater

The obvious signs are that the winding-rack is not in its at-rest position and the star-wheel arm **8** is within the tip circle of the star wheel (compare this with Figure 136 which is an almost identical repeater at rest). Note that the hour-snail star-wheel is hidden beneath the intermediate “pinion” **u**; the tips of the rays can be seen in Figure 147.

The large wheel in the center is for the *center seconds* hand which sits between the minute and hour hands; the hour-wheel has been removed. The center seconds wheel is driven by a pinion under the jewelled cock and the ratio of diameters indicate that this pinion rotates about once every 8 seconds; in which case it is presumably mounted on the escape wheel or on a special 5th wheel in the train.

There are three superimposed *strike racks* at **G**. The top rack strikes the minutes on the small hammer. The middle rack strikes the alternate ten-minutes on the small hammer. And the bottom rack strikes the hours and ten-minutes on the large hammer.

The *ten-minute counting piece*, Figure 148, has 6 teeth **22** for the 6 ten-minute intervals. The minute-counting piece gathering pallet **r'-1** is as described above. It is unlocked by pin **1'**, Figure 146, mounted on the foot of the ten-minute counting piece drop spring.

As this is based on a normal Stogden repeater, the hour-snail is geared to the canon pinion and has the same freedom and accuracy mechanisms that were described in Chapter 4. The arm **8** is the star-wheel arm. The purpose of the piece marked **?** is unknown; it may be a broken fragment.

Unlike the normal Stogden repeater, the ten-minute snail arm **c** is rigidly attached to the counting piece and so there must be some other freedom mechanism for the ten-minute snail.

Except for the position of the trip **t**, the *minute-counting piece*, Figure 149 (opposite), is the same as that in Breguet's repeater. Instead of a pin **2** mounted on the quarter-counting piece (as in Figure 138) to limit the drop of the minute-counting piece, the pin is placed on the minute-counting piece and acts in the oval slot in the ten-minute counting piece. **f'** is the drop spring.

Using the above formulae, a decimal repeater has $K = 6$ and $L = 10$; and so $N' = 20$ for $M = 2$ and $N' = 25$ for $M = 3$. This repeater uses $M = 2$ and the minute-counting piece should have 20 teeth. In fact it has only 19 teeth. There are two possible reasons. First, because the repeater has obviously been mistreated, the 1st or 20th tooth may have broken off or been removed. Second, in principle a 1st tooth is not strictly necessary because the pin **2** limits how far the minute-counting piece can drop and the piece can be lifted up by this pin instead of the 1st tooth. The latter is most likely because, as we will see, the Ellicott repeater also has too few teeth.

Because this repeater uses a rocking bar, it is not necessary to have two all-or-nothing pallets and two wedges. Instead, as in Figure 150, by moving a single wedge **z** further under the rocking bar arm the hammer pallets can be raised twice; as can be seen from Figures 146 and 147, the small all-or-nothing piece moves a considerable distance.

For this to work, the trip **t** on the minute-counting piece must be able to rotate the all-or-nothing pallet **z'** further than it has already been rotated by the ten-minute (or quarter) counting teeth **22**.

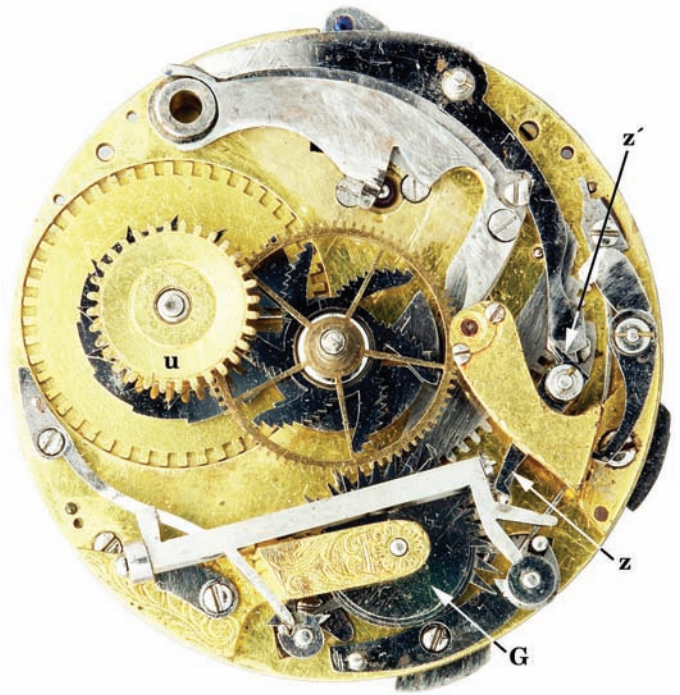

Figure 147

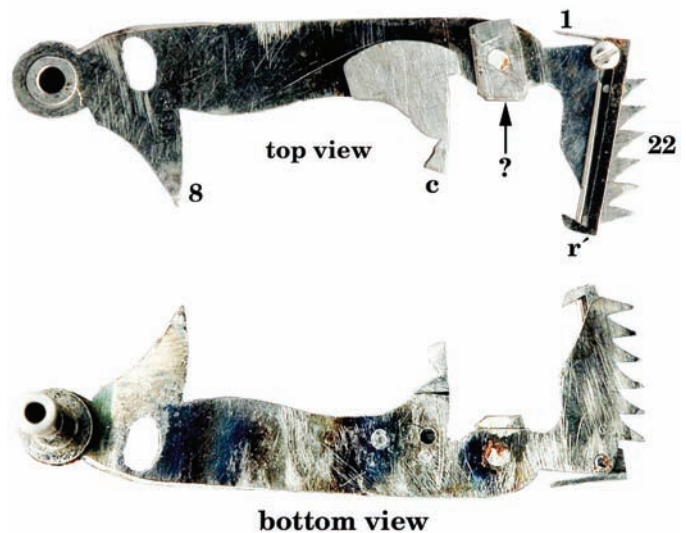

Figure 148

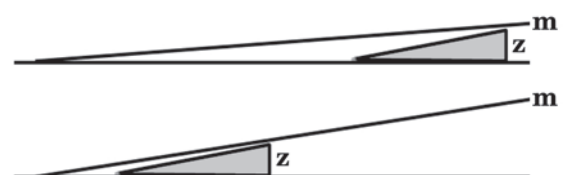

Figure 150

The Decimal Repeater

Which is why the trip in Arnold's repeater, Figure 149 *t*, is considerably further away from the ten-minute counting teeth *22* compared with the trip in Figures 137 and 138. (The same arrangement can just be seen in Figure 136.)

The trip is not on the same level as the ten-minute teeth *22*; indeed they are separated by the thickness of the gathering-pallet *r'*. And so the all-or-nothing pallet must be quite wide, or there needs to be two pallets. (In Figures 147 and 151 it seems that the small all-or-nothing piece *z-z'* actually consists of two superimposed pieces, the top one having a "hook" or "tooth" at each end. The exact form of it is unknown.)

In Figure 146 *m'* is the *small all-or-nothing locking piece*. When the repeater is at-rest, Figure 147, the end of the winding rack butts against the end of the locking piece, rotating it clockwise and holding the small all-or-nothing piece *z* under the rocker arm. (A similar locking piece can be seen in Figure 136.)

Finally, in Figure 146 *N* is the all-or-nothing rocker spring and *L* is probably the small-hammer pallet lift spring.

Freedom and accuracy for the hour-snail is the same as in an ordinary Stogden repeater, as described in Chapter 4.

The ten-minute and minute snails are fixed to each other, but both are loose and have their positions constrained by an integral straight spring, as shown in Figure 96 of Chapter 4 (page 53); some of the slot for the spring can be seen under the horizontal arm of the seconds wheel in Figure 151. This arrangement provides freedom for both snail-arms, Figure 148 *c* and Figure 149 *c'*; when rotation of the snails is impeded by the snail arms, the snails will remain stationary while the canon-pinion continues to advance. (Breguet's freedom mechanism, shown in Figure 96 of Chapter 4, is basically the same and was probably derived from a repeater made by Arnold.)

Minute-snail accuracy is achieved in a simpler way than Breguet's separate accuracy piece (Figure 138 *8'*, page 77).

As can be seen in Figure 152, the 0 minute steps of the minute-snail are shortened by rounding the backs of them off. So when the snail-arm drops during the 9th minute of a ten-minute period, it will slide down the face of the 0 minute step and land on the 9 minute step. In doing so it forces the minute-snail to rotate anti-clockwise, retarding it and the ten-minute snail, and so ensuring correct striking. In addition, the face of the snail arm *c'* is shaped so that it also retards the snails, as shown in Figure 153 where the arc is the path along which the tip of the snail arm travels.

Arnold's repeater depends on the accuracy with which the minute-snail is cut, because exactly on the ten-minute the snail arm *c'* must land precariously on the very end of the 0 minute step. If there is an error and the arm drops into the innermost step of the snail, *both* snails will be retarded, the repeater will sound the last minute of the previous period; and

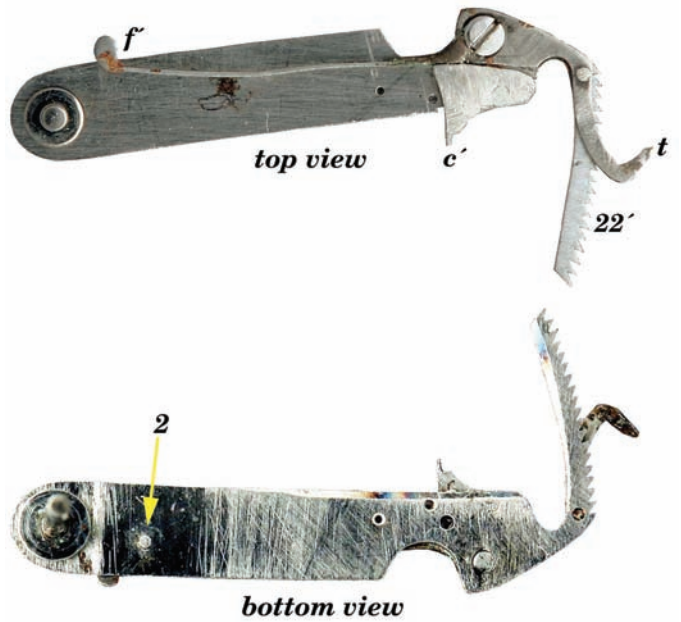

Figure 149



Figure 151



Figure 152

The Decimal Repeater

so the error will only be recognised from the position of the minute hand. (Hour striking will always be correct. If the ten-minute snail arm does not drop into the deepest step for the first period after the hour, the star-wheel arm **8** (Figure 146) will not advance the hour-snail and the previous hour will sound correctly.)

Wear over time will probably make such slight errors inevitable.

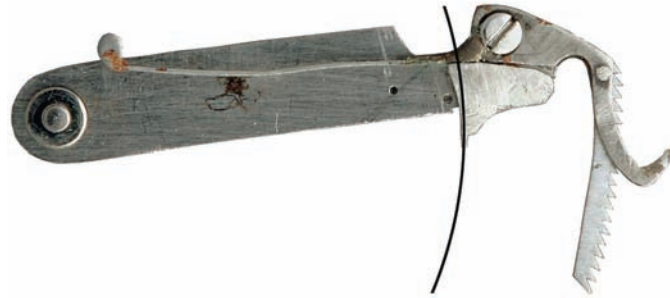

Figure 153

Ellicott's decimal repeater

The earliest of the decimal repeaters is signed by Ellicott and circa 1747.

Unlike Arnold's repeater, this watch has survived for 260 years in what appears to be original condition, although at some time in the past one part of the repeater mechanism was installed incorrectly. After Arndt Simon purchased it, it only required cleaning and repositioning the part to work correctly.

Figure 154 shows the repeater at rest with the minute-rack removed so that the pieces under it are easier to see.

Three main parts of the minute mechanism remain; the minute-snail **S'**, the minute gathering pallet **r'** above the ten-minute counting teeth **22**, and the minute all-or-nothing piece **A**.

Ignoring these, it is clear that the basic mechanism is a standard Stogden's repeater and it has the same design and action as the repeater described in Chapter 4:

- Freedom for the hour-snail **F** is controlled by the visible straight spring **s**, the hour-snail star-wheel (which, like Arnold's repeater, is hidden underneath the intermediate "pinion" **u**) and the star-wheel arm **8**.
- As with Breguet's and Arnold's repeaters, the ten-minute and minute snails are loose and controlled by a spring, with pin **II**, acting in a slot in the canon pinion, limiting their freedom.
- There are two, superimposed strike-racks **G** and **G'** which strike the hours and ten-minute intervals using the hammer pallets **Q** and **O**.
- The all-or-nothing mechanism uses the small all-or-nothing piece **z** to raise and drop the all-or-nothing rocker **M**; the arm of **M** on which it acts is hidden under the minute all-or-nothing piece **A**. The rocker, and hence the pallets **Q** and **O**, are raised only once to terminate ten-minute striking.

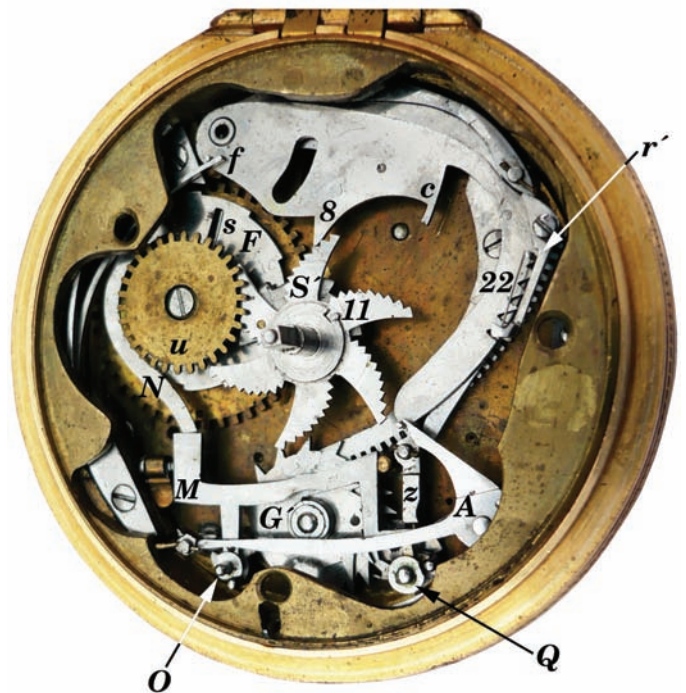

Figure 154

Figure 155 shows the complete repeater.

Unlike Breguet's and Arnold's repeaters, Ellicott's repeater uses a *minute-rack* **B-22'-N'**. This rack has 9 strike teeth **N'** acting on a separate hammer pallet **O'**. Unlike the other repeaters described in this section, the teeth **22'** do not count the number of minute strikes, but simply gather (raise) the minute-rack; this is similar in principle to the minute repeater described at Figure 59 in Chapter 3 (page 32).

The Decimal Repeater



Figure 155

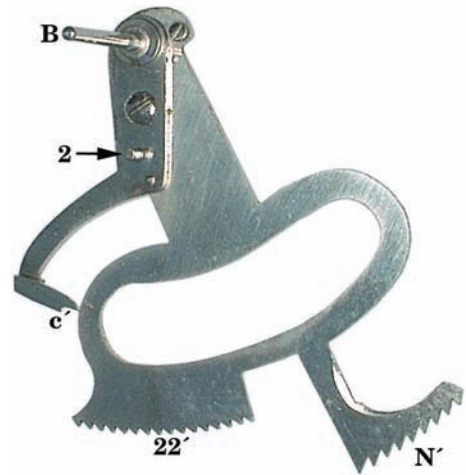

Figure 156

Figure 156 is an underneath view of the minute-rack showing the pin **2** which acts in the corresponding slot **2** in the ten-minute counting piece to limit the drop of the minute-rack.

The minute-rack has 16 gathering teeth **22'** whereas a minute counting piece requires exactly 15 ($K = 6, L = 10$). In fact, to be strictly correct there should be 18 teeth.

Figure 157 shows the repeater about to strike 2h 59m when the minute-rack has dropped as far as it can go. Note that the gathering pallet **r'** is *above* the gathering teeth **22'** and the minute-rack is raised by pin **2**, Figure 156.

Figure 158 shows the repeater about to strike 3h 0m when the minute-rack has moved the least distance. Here the gathering pallet **r'** has dropped well below the gathering teeth **22'** and there will be a pause before the minute-rack is lifted. But as 0 minutes strike this delay is irrelevant.

So ideally there should be another tooth at each end of the gathering pallet, but they are not necessary for correct operation. In fact, unlike Breguet's and Arnold's repeaters, almost any number of teeth will do, just as the normal minute

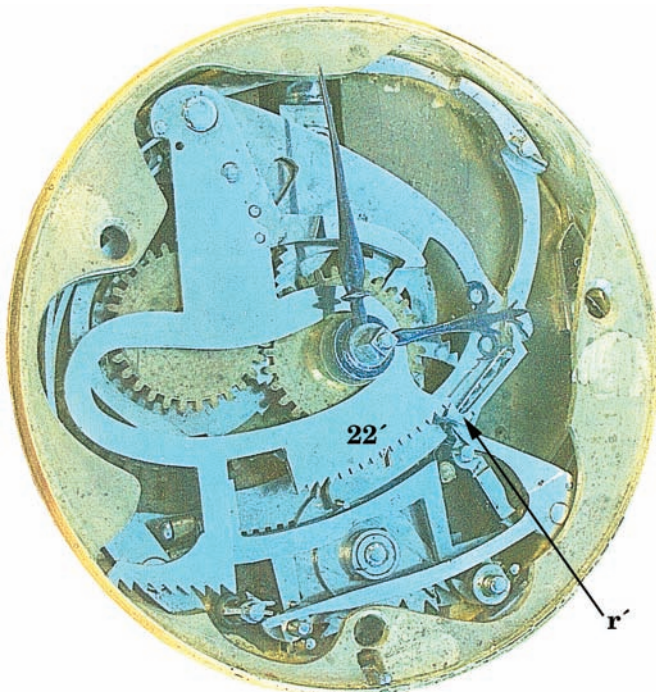

Figure 157

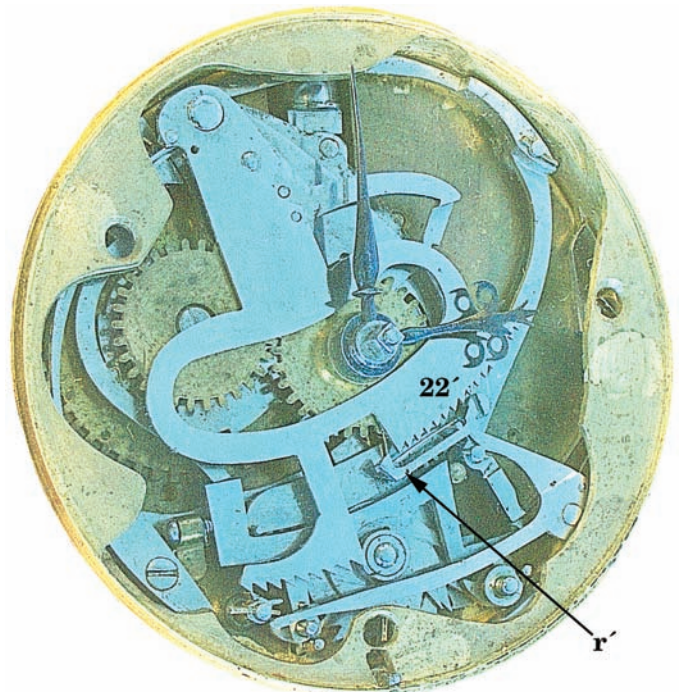

Figure 158

The Decimal Repeater

repeater (Chapter 3, Figure 59, page 32) works correctly with only 7 teeth. The only requirement is that the teeth and the gathering pallet successfully raise the minute-rack for striking.

When the repeater is activated, the minute-rack drops until the snail arm c' (directly above the ten-minute snail arm c) lands on the minute-snail S' ; at which point the correct number of minute strike teeth N' have passed the hammer pallet O' . After ten-minute striking, the winding-rack meets the ten-minute counting piece and raises it, the small all-or-nothing piece is rotated to lift the hammer pallets and terminate ten-minute striking, and the gathering pallet r' raises the minute-rack to strike the minutes.

The pallet O' does not act on the small hammer directly. Instead it meshes with the pallet O and trips that pallet to strike the minutes.

As shown in Figure 159, the minute all-or-nothing mechanism consists of the minute all-or-nothing piece A , the pin 3 mounted on the winding-rack, and the pin 4 mounted on the all-or-nothing rocker M .

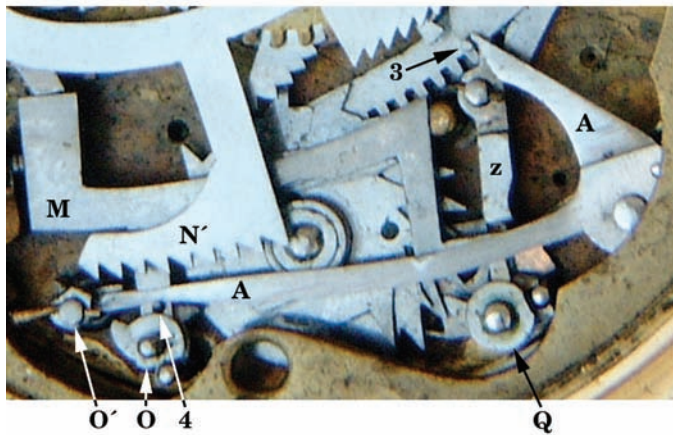

Figure 159



Figure 160 O'

The hammer pallet for minute striking O' , Figures 159 and 160, is controlled by a spring which rotates it clockwise to keep it in mesh with the minute strike teeth N' . However, when the repeater is at-rest, one end of the minute all-or-nothing piece A fits into the hammer pallet and holds it away from the strike teeth. The minute all-or-nothing piece A is controlled by a spring and is always trying to rotate anti-clockwise and release the pallet. It is prevented from doing so by pin 4 on the all-or-nothing rocker M . (Pin 3 on the winding-rack also prevents rotation, but that is not its function, as we will see.)

When the repeater is activated, pin 3 moves away from the minute all-or-nothing piece, but it is still prevented from moving by pin 4 , until the small all-or-nothing piece z releases the all-or-nothing rocker M .

When this happens, Figure 161, pin 4 drops below the minute all-or-nothing piece, which is now free to rotate, and it releases the hammer pallet O' which moves into mesh with the minute strike teeth N' . That is, minute striking cannot occur unless the all-or-nothing mechanism is unlocked by the hour-snail arm reaching the hour-snail.

After striking, the minute all-or-nothing piece must be returned to the position in Figure 159, against the force of its spring. This is the purpose of pin 3 on the winding rack. However, this movement is blocked by pin 4 , because after ten-minute striking and before minute striking the small all-or-nothing piece z raises the rocker M . And so A must lift up and over the pin. To achieve this, both the pin 4 and the corresponding face of A are sloped. When striking has completed, pin 3 on the winding rack meets the minute all-or-nothing piece and forces it to rotate clockwise. The other end of the piece rides up and over pin 4 and drops down behind it, so that the pallet O' is moved out of mesh with the strike teeth N' and A is locked in its at-rest position.

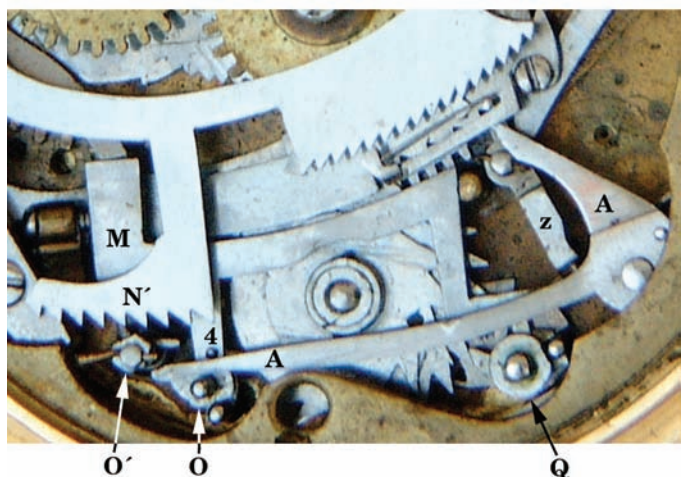

Figure 161

The Decimal Repeater

Finally, minute-snail and ten-minute-snail accuracy and freedom is the same as that in Arnold's repeater. The 0 minute steps are narrowed and the snail-arm c' has a curved back running to a very fine tip; this can be seen in Figures 155 and 156. Just before the end of each ten-minute interval, the snail arm will drop into the inner, 9-minute step, retarding both snails and ensuring correct striking. As with Arnold's repeater, wear on the minute-snail face or the snail-arm c' may eventually produce a slight inaccuracy.

Chapter 7: The Grande Sonnerie Clock-Watch

Basic principles

A *grande sonnerie* watch strikes the hours and quarters *en passant*; that is, automatically in passing. It also acts as a repeater and will strike on demand when the watch owner wants to know the time; so the underlying mechanism is usually a minute repeater with the features that have been described in Chapter 3. This explanation is of the design described in Lecoultre, *A Guide to Complicated Watches*, and Emile James *Traité des Sonneries* (1815 and 1899).

The most obvious, but relatively simple change is to the power source.

Repeaters use a winding-rack and a small repeater-spring with one used turn to operate the repeater mechanism, and the user has to move the winding-rack to activate the repeater. In contrast, a clock-watch requires a large sonnerie barrel with a spring long enough to provide power for twenty-four hours or more of striking, so there are usually two barrels. (Keyless winding uses a variety of methods to enable separate winding of the two barrels.)

Figure 162 shows the sonnerie barrel with the small train to control the speed of striking (yellow), ending with a centrifugal fly (see Figure 40, page 22).

Figures 163 and 164 show the minute repeater mechanism. With the exception of the control mechanism, shown in red, it is a normal minute repeater and the mechanism is identical to the minute repeaters in Chapter 3.

13 is the *winding-rack*. In a repeater, the winding rack performs three tasks:

- (a) It winds the repeater spring to provide power to the mechanism.
- (b) It determines the number of hours to be struck by the hour-rack **7** using an arm that rests on the hour snail.
- (c) It releases the mechanism by moving the all-or-nothing piece.

Figures 38 (page 22) and 72 (page 37) illustrate winding-racks.

In a sonnerie watch the corresponding piece, which should be called the *sonnerie-rack*, has only one function, to determine the number of hours to be struck. There is no all-or-nothing mechanism, because the automatic release mechanism guarantees that the striking is correct, and winding occurs separately.

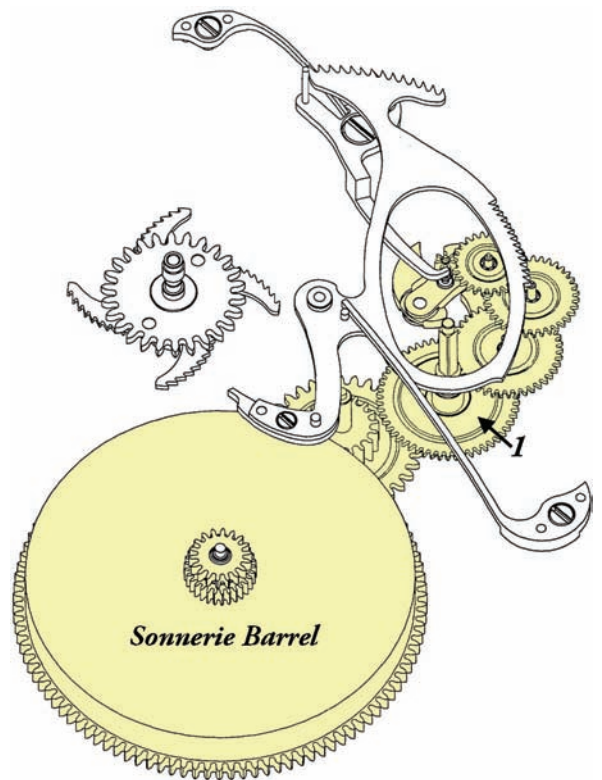

Figure 162

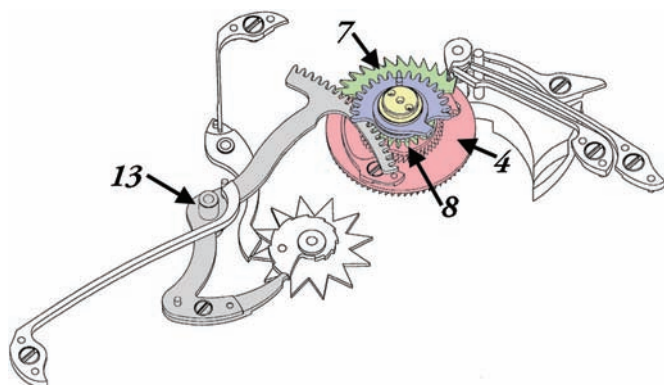

Figure 163

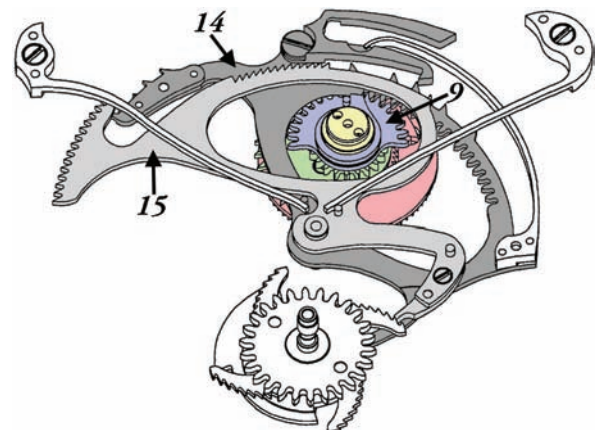

Figure 164

The Grande Sonnerie Clock-Watch

The hour-rack **7**, minute-rack **15** and quarter-rack **14** are the same as in minute repeaters with one difference; in this mechanism the minute-rack is used to release the small train, as shown later.

Striking

The easiest way to explain the mechanism is to start with the position shown in Figures 163 and 164, when the racks have fallen onto the snails and striking is about to commence.

Figure 165 shows the *sonnerie mechanism* mounted on the second wheel of the small train, **1**. It consists of the *release mechanism* (red), the *hour striking mechanism* (green) and the *quarter/minute striking mechanism* (blue), held together by a pinned or screwed cap **12**. The only part squared onto the small train is the *release disk* **4**.

During striking, the sonnerie spring rotates the release disk anti-clockwise and the *release disk click* **5**, meshing with the *driving ratchet* **6**, rotates the *hour-rack* **7**. The *gathering pallet* **11** (squared onto the hour-rack) raises the quarter-rack via the pinion **9** and its pin **10**, which in turn raises the minute-rack (see Figure 164). In this design, when striking finishes, the minute-rack **15**, Figure 166, moves the *train lock lever* **16** by the pin **17** so that its end fits between two leaves of the final pinion of the small train and stops the small train from rotating. This locks the mechanism with the sonnerie-rack **13** (Figure 163), quarter-rack and minute-rack raised, and the release disk click meshing with the driving ratchet.

Strike timing is the same as in a minute repeater, Figures 61 and 62, page 33.

Automatic release

The *release arm* **20**, Figure 167, has the loose *release click* **21** mounted on it and the spring on the arm ensures that the click is always in mesh with the *release ratchet* **2**; in Figure 167 only part of the release ratchet **2** is shown beneath the release disk **4**. The *release pallet* **19** is mounted on the plate. A spring (not shown) tries to rotate the release arm anti-clockwise around its pivot **20'**, pressing it against the two arms of the release pallet.

In addition to the snails and freedom pieces, the cannon pinion has the *release trigger* **18** squared onto it. This has four arms aligned with each 15 minutes.

As the canon pinion rotates clockwise, the release trigger rotates the release pallet **19** anti-clockwise and it in turn rotates the *release arm* **20** clockwise so that the release click **21** slides over a few teeth of the release ratchet.

Exactly at the 15 minute points, the release trigger frees the release pallet and the spring makes the release arm rotate anti-clockwise until the release arm is again pressed against the two arms of the pallet. This action drives the release ratchet a few teeth anti-clockwise *relative to the release disk*; this is possible because the screws holding the release ratchet to the release disk run in elongated holes (Figure 165).

The *release pin* **3** is mounted on the release ratchet and passes through a sufficiently large hole in the release disk; the release disk click **5** rests against this pin. When the trigger forces the release arm and the release ratchet to rotate anti-clockwise, the pin rotates anti-clockwise relative to the release disk and it lifts the release disk click so that it is no longer in mesh with the driving ratchet **6**.

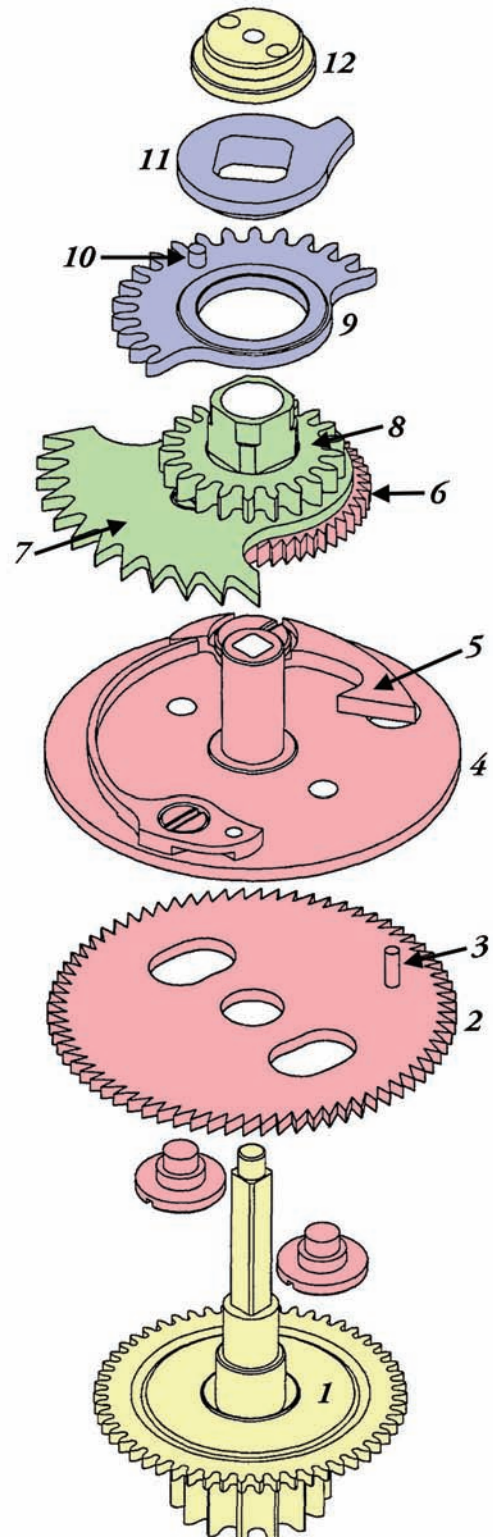

Figure 165

The Grande Sonnerie Clock-Watch

At this point the hour rack **7** is free and rotates clockwise until the sonnerie rack **13** (Figure 163) has dropped onto the hour-snail. The gathering pallet **11** rotates with it, allowing the quarter rack **14** and minute rack **15** (Figure 164) to drop onto their respective snails, and the train lock lever **16** releases the small train.

When the small train is released, the release disk starts rotating anti-clockwise, but the release ratchet does not move; it cannot rotate clockwise because of the release arm and it cannot rotate anti-clockwise because of the release disk click. So the release disk rotates anti-clockwise relative to the release ratchet and the click slowly drops until it meshes with the driving ratchet. Now the pieces are in the position before striking starts and striking occurs as described above.

Because there is no all-or-nothing mechanism it is possible that the click can mesh with the driving ratchet before the racks have dropped completely and, consequently, the hole in the release disk for the pin **3** must be large enough for this movement.

Note that during striking the release pin **3** causes the release ratchet **2** to rotate with the release disk **4** and the release click **21** slides over the ratchet teeth.

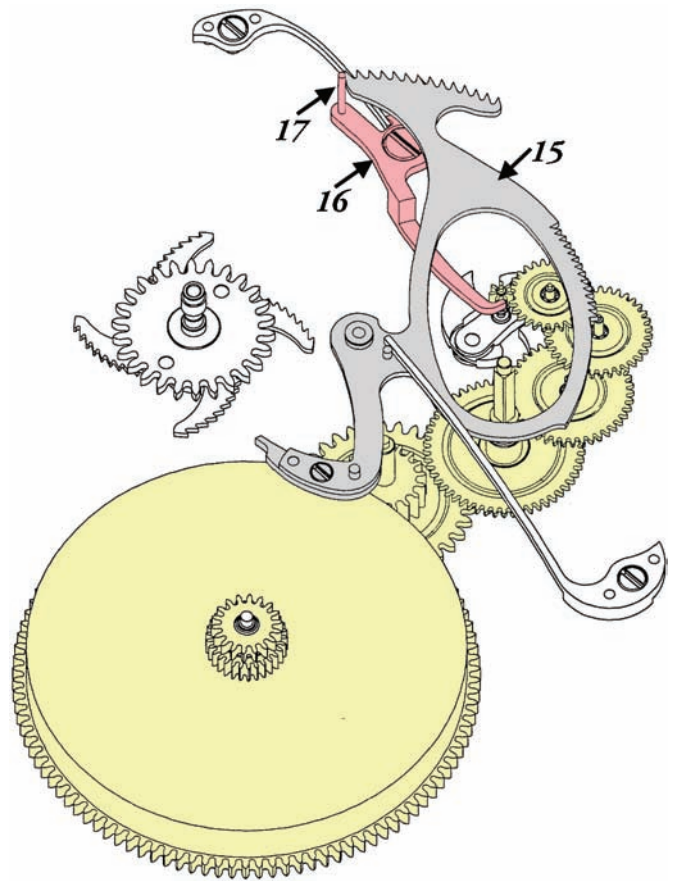

Figure 166

Silencer

A silencer is provided to prevent automatic striking when it is not wanted, Figure 168. This consists of a slide **22** in the case band. When moved, it rotates the *silencer lever* **23** to hold the release click **21** away from the release ratchet so that it cannot release striking.

Note that the release trigger, release pallet and release arm function normally every 15 minutes.

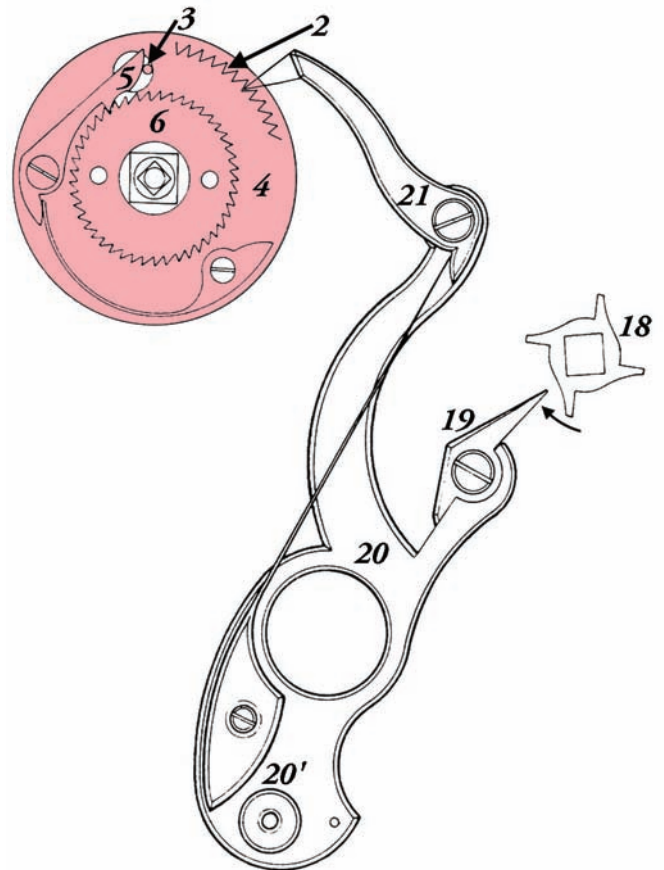

Figure 167

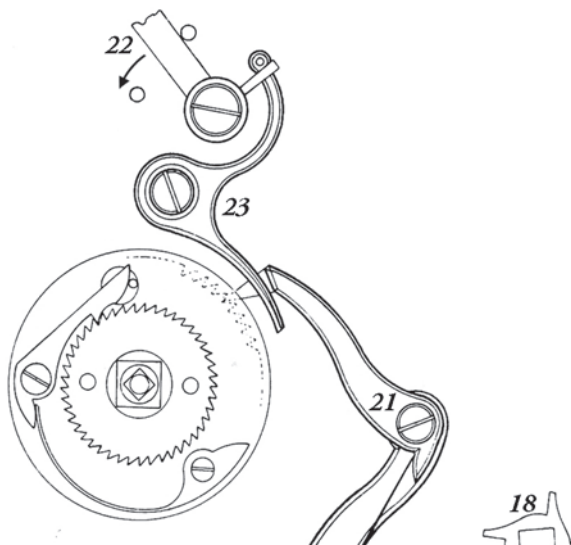

Figure 168

Manual release

To allow the watch to function as a minute repeater, a second release mechanism is used, Figure 169.

This manual release mechanism is similar to the automatic release mechanism, and it consists of two parts, a release mechanism and a lock mechanism.

First, the release mechanism (green): A slide **24** in the case band rotates the manual release lever **25** anti-clockwise. That lever rotates the release arm **26** clockwise, and the release click **27** drives the release ratchet **2** a few teeth anti-clockwise. Now the mechanism functions as described above. (A spring, not shown, ensures that the release arm is always held against the release lever.)

During this process, the automatic release click **21** (Figure 167) slides harmlessly over the teeth of the release ratchet (and vice versa during automatic striking).

Second, the lock mechanism (yellow): The *train lock lever* **16** has a different form to that in Figure 166, but performs the same function. When the minute-rack rises it moves pin **17** to the right, rotating the train lock lever clockwise so that the pin **28** enters the teeth of a small train pinion to lock the small train; the spring **29** rotates the train lock lever anti-clockwise when it is released. The end **30** of the lever is flexible to allow for this movement when the manual release lever **25** does not move.

The manual release lever **25** also locks the small train until the slide is released. That is, the release disk click **5** is held away from the driving ratchet **6** with the racks dropped onto their respective snails, but striking does not occur until the slide returns to its original position.

Lecoultré states that “this stoppage of the train is necessary, in order to prevent striking whilst pressure is exerted on the caseband bolt.” However there is no reason why striking cannot occur in this position, as nothing in the mechanism will cause incorrect operation. But there may be a problem if the user of the watch does not move the slide its full distance. Then the release click **5** could be raised just sufficiently to free the driving ratchet **6** and it could re-engage with the driving ratchet before the racks have dropped fully onto the snails, leading to incorrect striking.

Watch owners can be irrational and “test” their watches in unexpected ways; which is a problem with the IWC repeater and hand setting (see Figure 133 and the text, page 70). Hand setting in a clock-watch will be considered later, but there is another possible problem: What happens if automatic striking has commenced and the owner activates the manual release at the same time? That is (Figure 169), the racks have dropped onto their respective snails, the release disk click **5** is engaged with the driving ratchet **6** and striking has commenced.

Moving the slide **24** will cause striking to stop, as the pin **28** locks the small train, the release click **27** will rotate the release disk click **5** out of mesh with the driving ratchet **6** and the racks will drop back onto their snails! So striking will start again when the slide is released.

What happens without the lock mechanism? That is, the train lock lever **16** does not have the tongue **30**. Now the release ratchet, the release disk click and the driving ratchet are all rotating anti-clockwise, and whether the release click will rotate the release disk click out of mesh with the driving ratchet or not depends on how fast the slide is moved. If slowly enough it will have no effect on striking. If fast enough it will reset striking as above. And somewhere in between

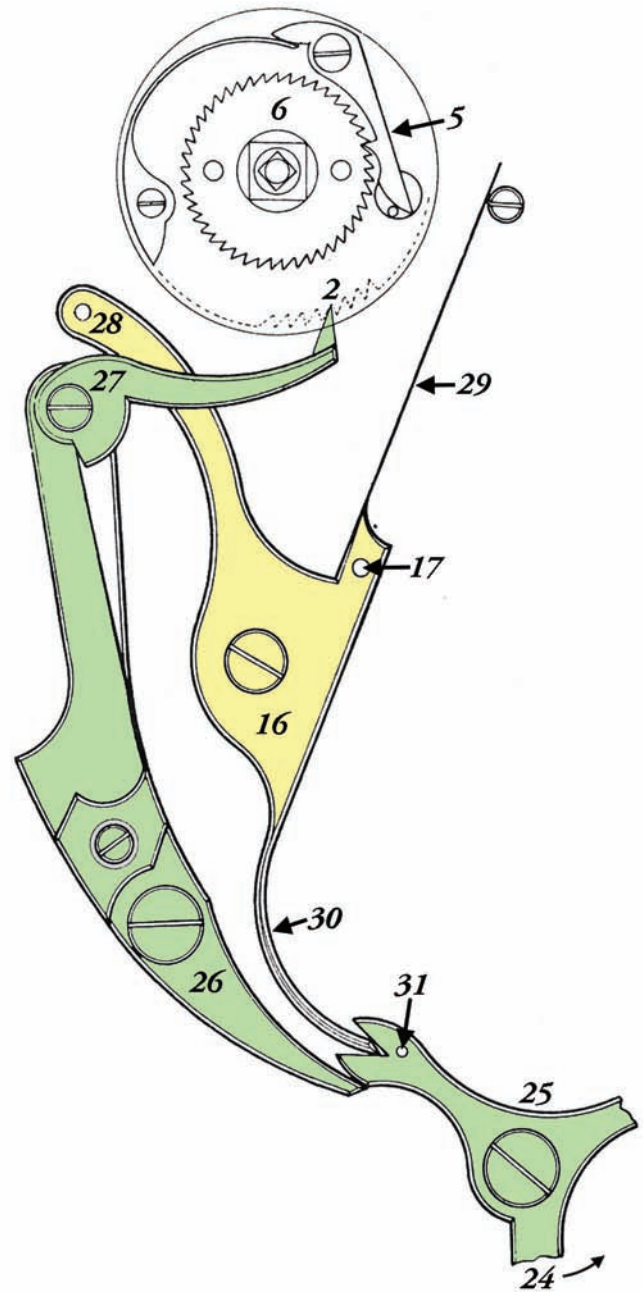

Figure 169

the rack will not drop completely and incorrect striking will occur; which is not really a problem as the striking is already incorrect.

What happens also depends on the state of automatic striking. For example, if the slide is operated during hour striking the quarter and minute racks are still resting on their snails and only the hour striking will recommence.

Suppression of hour striking

Automatic striking sounds the hours at every quarter, and the mechanism in Figure 170 prevents hour striking except at the full hours.

The minute wheel of the motion-work rotates once every three hours. Fixed to it is a three-tooth star wheel **33**, aligned so that it can lift the *hour suppression lever* **32** (red) on every hour. A spring holds the lever in the anti-clockwise position shown, when hour striking is suppressed.

Except for on the hour, arm **35** of the hour suppression lever is in the path of the pin **36** that is attached to an arm of the sonnerie-rack **13** (yellow). In this position the sonnerie-rack cannot drop onto the hour snail and hour striking does not occur. Once every hour, the star wheel **33** lifts the end of the hour suppression lever, rotating it clockwise so that the arm **35** is not in the path of the pin **36** and the sonnerie-rack can drop to sound the hour.

A slide **34** in the case band can be used to rotate the lever and allow hour striking at every quarter.

When the manual release is used, the hour must sound irrespective of the position of the slide. For this, the manual release lever **25** (green) has a pin **37** that rotates the hour suppression lever clockwise to allow the hour to sound.

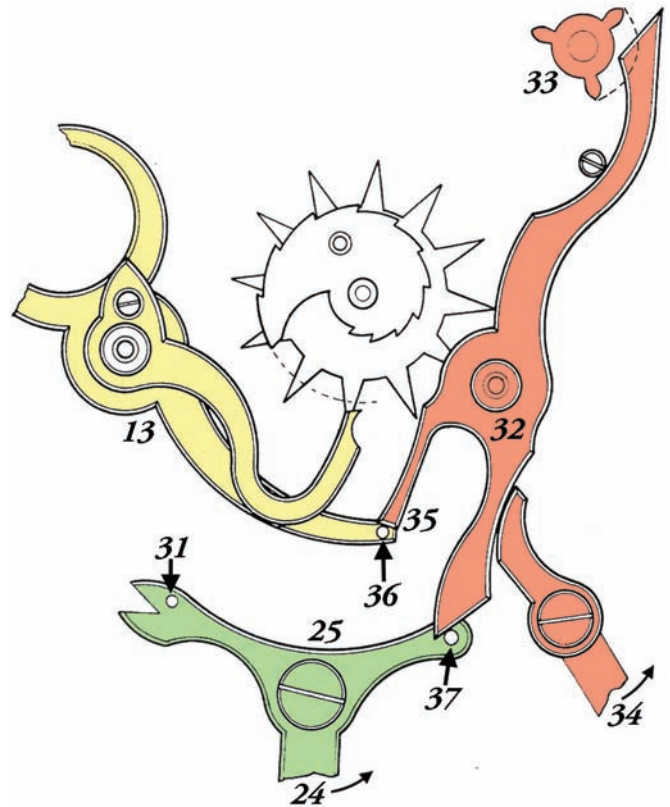

Figure 170

The minute-rack stop

The automatic release occurs exactly on each quarter hour. At this time, when the minute-rack drops onto its snail, zero minutes will sound. However, although apparently unnecessary, a clock-watch can include a mechanism to stop the minute-rack from dropping, Figure 171. The minute-rack **15** (yellow) has a stop pin **39** and the *minute-rack stop lever* **38** (green) lies in the path of this pin, preventing the minute-rack falling on automatic release.

However, the minute-rack must drop a short distance so that pin **17** on the train lock lever **16** (Figure 169) can move to the left and unlock the small train, and so there is a gap between the stop lever and the stop pin to allow for this.

The minute-rack has to drop when the manual release is used. To do this, pin **31** on the manual release lever **25** (Figure 170) moves the stop lever **38** out of the way of the stop pin **39**.

If manual release is activated during striking, the stop lever will move and the minute-rack will drop onto the snail. The shape of the stop lever must allow for this movement when the stop pin is resting on it.

The jumper **40** (blue) controls the movement of the minute-snail freedom piece (see page 36).

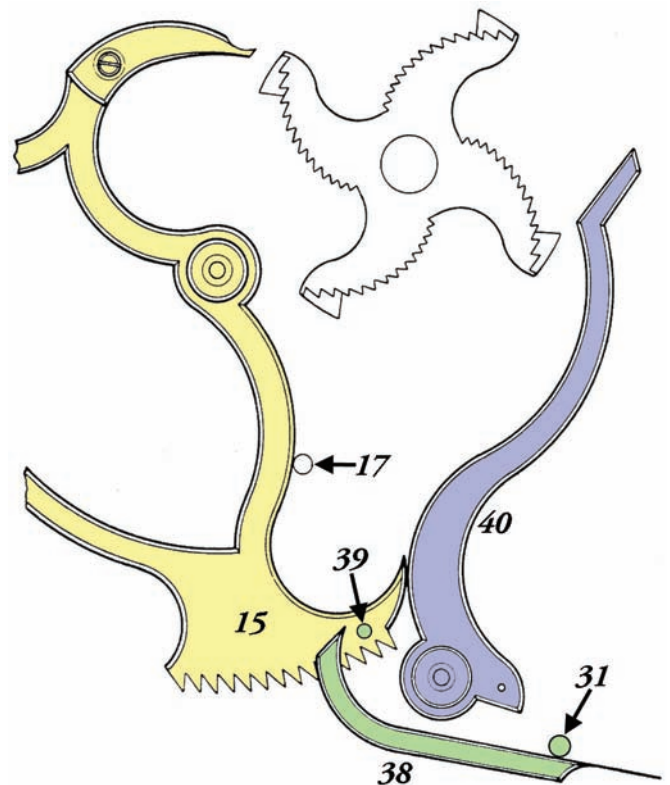

Figure 171

Hand setting

Understanding the effect of setting the hands is complex, especially as “stupid” behaviour of the owner must be considered. So it is necessary to look at setting the hands both forward and backward. And this can happen across 15 minute boundaries with automatic striking, with or without the silencer activated, and with manual striking, when the silencer has no effect.

There are, indeed, at least 24 different cases that should be examined, but they can be grouped together:

(a) *Automatic striking with the silencer activated:*

This is the same as hand setting in an ordinary minute repeater when it is not striking (see page 39).

(b) *Automatic striking with the silencer deactivated:*

If done slowly and sensibly, starting when the watch is not striking, turning the hands forward replicates normal running, but faster; although it is necessary to pause at every quarter to allow time for the mechanism to strike. (Actually it is desirable for repeaters and clock-watches to be adjusted so that they lose time rather than gain time, because then the hands are always adjusted forward.)

If the hands are turned forward rapidly after striking has commenced, then the behaviour depends on whether the watch has the minute-rack stop mechanism or not.

Without the minute-rack stop, the minute-rack is free during hour striking and will drop onto the successive steps of the minute-snail (and the minutes can sound unexpectedly but correctly) until it drops into the 14-minute step and the arm of the minute rack jams against the snail with possible damage occurring. This will happen at the end of every quarter.

With the minute-rack stop, the minute-rack does not drop and the mechanism behaves like a quarter repeater. The quarter rack can drop as the hands advance across the 15 minute boundaries until the arm jams against the quarter-snail on the hour.

If the hands are turned backward the minute-rack will drop into the 14-minute step and then jam against the previous step. With the minute-rack stop this problem occurs with the quarter-rack.

This backward motion of the canon pinion will also have an effect on the release trigger **18** (Figure 167).

However, the anti-clockwise motion of the release arm will be small and, hopefully, not enough to release the driving ratchet.

(c) *Manual striking:*

If manual striking is activated, then the mechanism behaves like a minute repeater and the effects of hand setting is the same as automatic striking without the minute-rack stop mechanism.

To try to avoid these problems, when a keyless watch has its pendant (or rocking bar) moved into the hand-setting position there is an additional *isolator* lever that activates the silencer mechanism and allows problem-free hand setting (almost!). This needs to act on both the automatic and manual release mechanisms. Assuming “stupidity knows no bounds” the isolator cannot resolve every problem; if the keyless mechanism is moved to the hand setting position after striking has commenced the isolator has no effect.

There is no simple solution for key wound and set watches. The best that can be hoped for is that the owner follows instructions not to move the hands while the watch is striking.