

K&D





STAKING TOOLS

and how to use them ...



**K&D
Staking Tools,
Accessories,
and other
Watchmakers'
Tools**



We acknowledge with thanks the technical information on the care of the Staking Tool provided by Fred Mosher.

K&D

STAKING TOOLS



... like any other precision product, must be given proper care and attention in order for you to attain complete satisfaction and produce quality workmanship. Years of technical "know-how" have enabled Kendrick and Davis Company, manufacturers of watchmakers' tools since 1876, to produce the best Staking Tool at the most reasonable price.

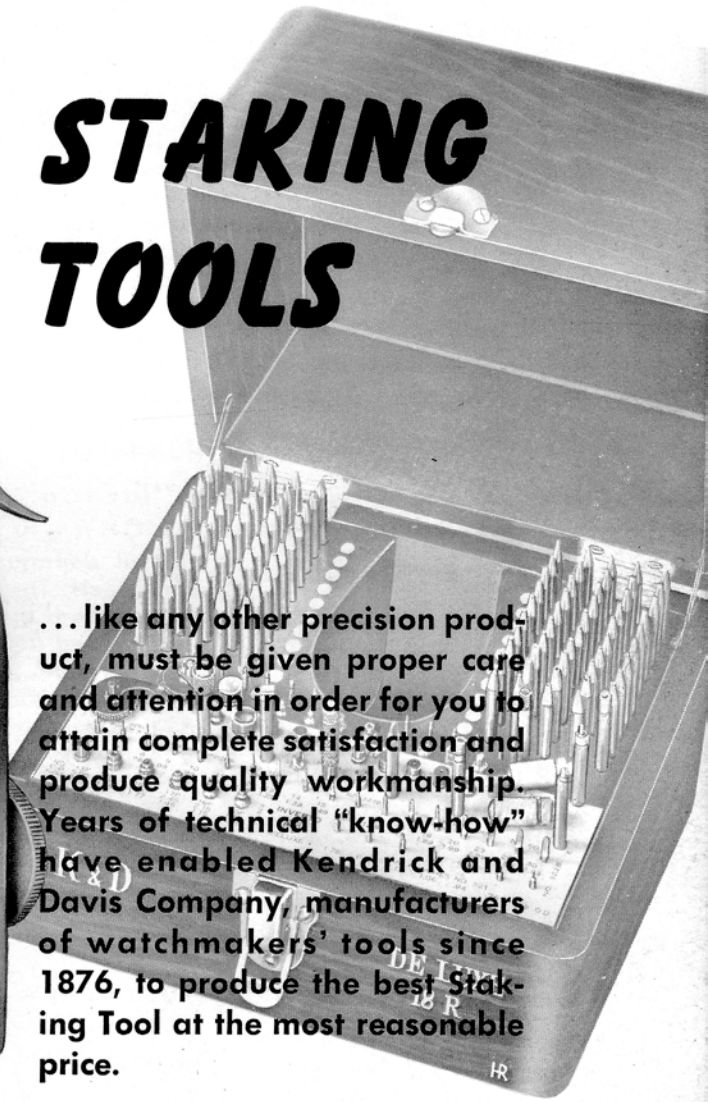

WHY **K&D** IS THE BEST STAKING



The K&D frame design . . .

is a result of years of experimentation. They have more accuracy and more die binding power — are chrome plated giving the tool an attractive appearance and to prevent rust. The new cut-away front makes it easy to invert punches.

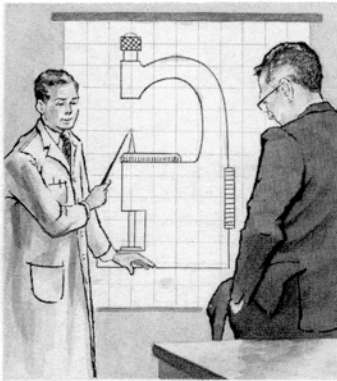

K&D pioneered the "Inverto" frame . . .

a radical departure from all previous Staking Tools. The tool is called Inverto because any of the punches may be inverted, passed down to the largest hole in the die and be used as a stump. Every watchmaker will recognize this as a great advantage, for the flexibility of being able to use every punch in the set as a stump is needed almost daily.

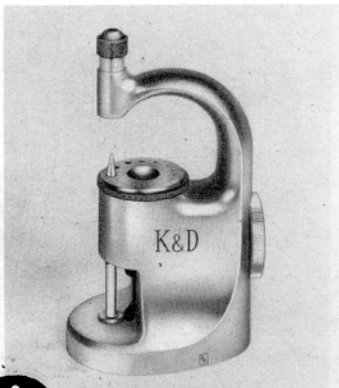

To invert punch for use as a stump . . .

release the die binder and pass the punch down through the Staking Tool head and through the largest hole in the dieplate. The end of the punch will automatically seat itself in the centering hole in the base plate. Center the punch with the set punch and tighten the dieplate. To remove the punch, pass it back through the dieplate and Staking Tool head.

TOOL THAT MONEY CAN BUY...

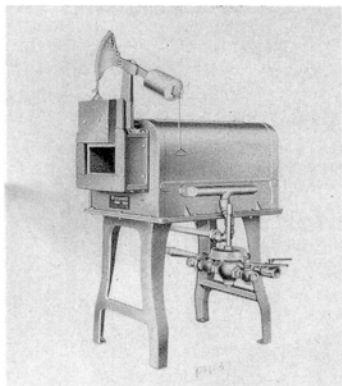

The highest grade of steel obtainable . . .

is used to make all K&D tools. The punches, stumps and dies are correctly tempered in electrically controlled gas furnaces to withstand all normal wear.

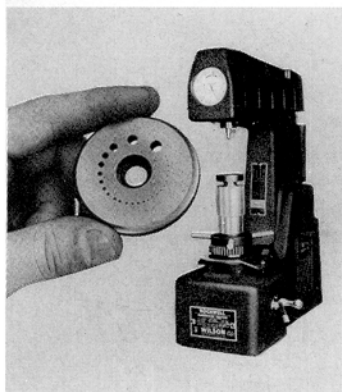

K&D dieplates are diamond tested . . .

on a Rockwell testing machine to guarantee maximum hardness with greatest working efficiency. A small indentation on the face of each die is a result of this test — and your guarantee of a properly tempered dieplate.

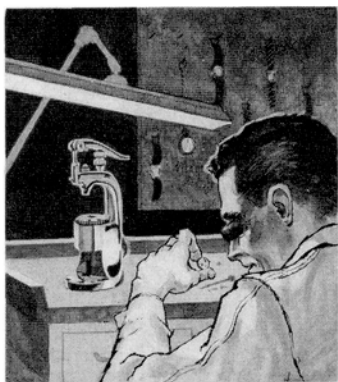

In modern watch repairing . . .

the Staking Tool has replaced the lathe as the "basic" tool on the bench. Versatility is of the greatest importance. K&D has available a wider range of punches, stumps and attachments (such as friction jewelers) than any other Staking Tool.

CARE OF THE K&D STAKING TOOL

The following hints or suggestions are intended to help you get the most from your Staking Tool and prolong its life.

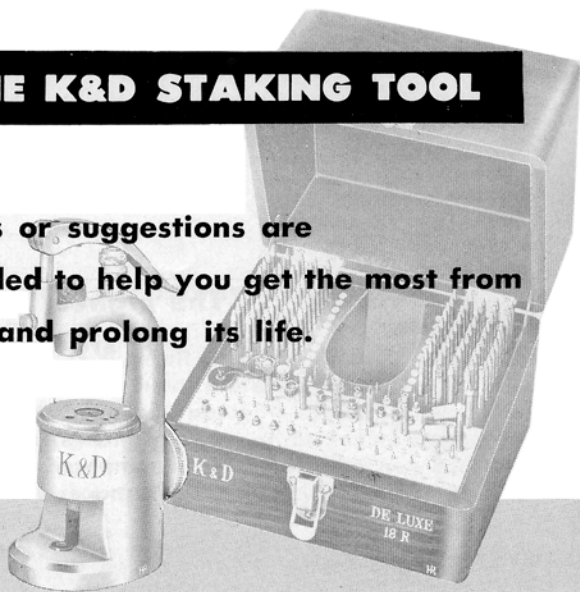

In handling the frame itself . . .

most watchmakers prefer to center the die and tighten with the die binder while resting the frame firmly on the bench. Others like the dieplate to "float" or remain loose since this allows for self-centering of the punch and staff.

Some prefer to hold the frame . . .

by the neck (off the bench) because they feel that the double blow (caused by the dieplate and punch against the staff from both sides) lessens the pressure on both parts and does a better all around job.



Always use a brass hammer . . .

which saves battering your punches. If a steel hammer is used, the end of the punch may flatten out and make it impossible to invert in the frame. We recommend using the K&D #91 brass hammer which was made especially for Staking Tools.

Light tapping . . .

will stake a staff properly and sufficiently tight. It is recommended to turn the punch slightly between the taps or turning the balance wheel to produce a better job. Forceful pounding quite frequently will cause distortion of the balance arm as well as damage the die and punches.

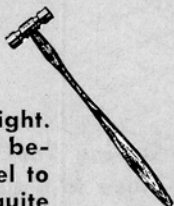

American made balance staffs are harder . . .

than Swiss staffs, and for this reason the use of stumps or inverted punches is recommended to avoid direct wear on the expensive dieplate.

Check periodically for rust . . .

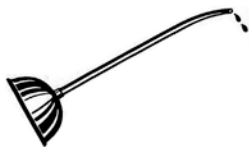

and remove from punches and die with fine emery paper. Turning the punches in your lathe will speed the job of rust removal. To prevent rust from summer humidity and perspiration, the punches and the dieplate should be periodically wiped with a rag saturated with lathe oil.

Check punches for wear . . .

about once a month, especially the flat and round face hole punches in the most used sizes. Good workmanship can not be expected if you use a worn or battered punch. Replacements are inexpensive and well worth the investment.



CORRECT USE OF

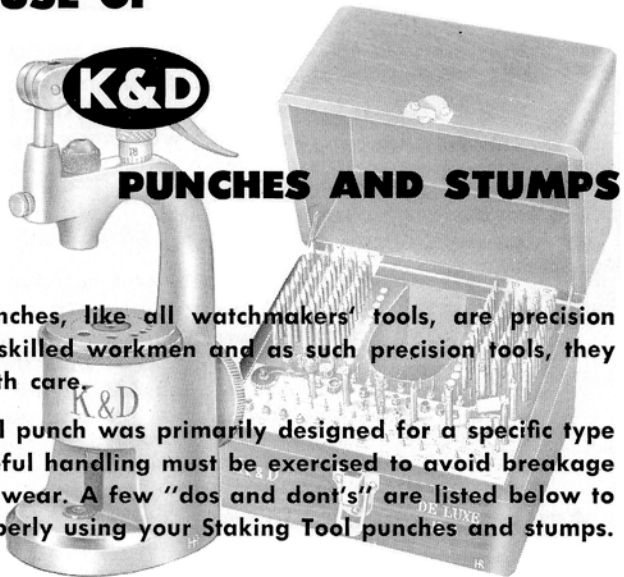

PUNCHES AND STUMPS

Staking Tool punches, like all watchmakers' tools, are precision made to benefit skilled workmen and as such precision tools, they must be used with care.

Each Staking Tool punch was primarily designed for a specific type of work and careful handling must be exercised to avoid breakage and unnecessary wear. A few "dos and don'ts" are listed below to assist you in properly using your Staking Tool punches and stumps.

K&D

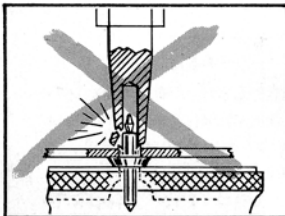

WRONG

**CHECK PUNCH
SIZE CAREFULLY**

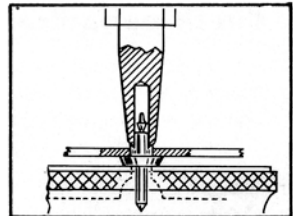

RIGHT

For staking staffs and pinions . . .

the common practice is to use a round faced hole punch first to flatten the undercut of the balance staff over the balance arm. A flat faced hole punch is then used to finish the riveting and to bring it firmly down over the arm. If a punch fits too tightly over the hairspring shoulder of the staff, it will not produce a good job and may even split the punch.

For closing holes . . .

round faced solid punches are generally used and should only be used in the Staking Tool frame to avoid off center jobs. If used on steel, extra caution should be exercised to avoid breakage — use light blows.

Small cross hole and special Waltham punches . . .

are the most delicate and often misused punches. Do not use these punches for any other purpose than that for which they are designed.



K&D

GUARANTEE OF PUNCHES

A fair understanding promotes good feeling and confidence. K&D Staking Tool punches are properly made of fine quality steel and tempered to the degree most suited for the purpose intended. Should any punch be found defective in workmanship, material or temper, we will replace it without charge. However, the best of punches can be broken and unless the broken punch shows a flaw in the steel or other imperfection, we must charge for replacing them.

K&D

When steel is hardened to the highest degree it cannot be tough at the same time, for example, round face hole punches made chiefly for riveting staffs, pinions, etc., must be tempered very hard so that they will not become battered. If the punch is used correctly, it would last for years but once put over a staff or pinion a little too large for the hole, the punch will split. If it did not split, it would show conclusively that it was too soft to be a good and durable riveting punch. Hole punches thus broken usually show a bright surface inside the hole at the mouth of the punch.

K&D

Another type of punch such as cross hole punches and those for knocking out broken screws must be tempered tough. These if tempered hard as a riveting punch would be broken the first time they were used. Taper mouth hole punches also need to be drawn to a lower temper than riveting punches.

K&D

We pack all goods with great care and leave our plant in good order. We cannot be responsible for damage done by transportation companies. Goods arriving in damaged condition should be accepted for as in such condition and a claim made to the company delivering them for reimbursement.

For description and use, see pages 12 to 17

<i>Punch No.</i>		<i>Hole Diam.</i>	<i>Punch No.</i>		<i>End Hole Diam.</i>	<i>Hole Diam.</i>
★★★ 1	Set Punch		★★★ 26	Staking Rollers63
★ 7	Cross Hole Punches16	★ 26B	Staking Rollers51
★★★ 8	Cross Hole Punches18	★ 26C	Staking Rollers41
★★★ 9	Cross Hole Punches21	★★ 27	Closing Collets		1.40
★★ 10	Cross Hole Punches25	★★ 28	Closing Collets		1.18
★★ 11	Cross Hole Punches31	★ 29	Taper Mouth Closing ..	4.71	1.84
11A	Punch with Centered End35	★ 30	Taper Mouth Closing ..	3.76	1.40
★ 12	Triangular Punch		★★★ 31	Taper Mouth Closing ..	3.53	1.09
★★★ 13	Prick Punch		★★★ 32	Taper Mouth Closing ..	2.90	.91
★★★ 14	Peening Punch		★ 33	Taper Mouth Closing ..	2.68	.84
★ 15	Stretching and Peening		★★★ 34	Taper Mouth Closing ..	2.15	.79
★ 16	Center Wheel Punch	1.94	★★★ 35	Taper Mouth Closing ..	2.01	.66
★ 17	Center Wheel Punch	1.51	★★★ 36	Taper Mouth Closing ..	1.61	.61
★ 18	Center Wheel Punch	1.18	★ 37	Taper Mouth Closing ..	1.40	.53
19	Staking Double Rollers	1.94	★★★ 38	Taper Mouth Closing ..	1.15	.46
20	Staking Double Rollers	1.51	★ 38A	Taper Mouth Closing ..	.99	.31
20A	Staking Double Rollers Incabloc		★ 39	For Waltham Detachable Staffs (driving out) ..	.71	.21
21	Staking Double Rollers	1.04	★ 40	For Waltham Detachable Staffs (driving in)	1.14	.63
21A	Staking Double Rollers Incabloc		★ 41	For Waltham Detachable Staffs (driving in)94	.61
22	Staking Double Rollers89	★ 42	For Waltham Detachable Staffs (driving in)76	.45
23	Staking Rollers	1.32				
24	Staking Rollers	1.02				
★★ 25	Staking Rollers79				

FLAT FACE HOLE PUNCHES

<i>Punch No.</i>	<i>Hole Diam.</i>	<i>Punch No.</i>	<i>Hole Diam.</i>	<i>Punch No.</i>	<i>Hole Diam.</i>
43	2.54	★★★ 55	.97	★★★ 65	.60
44	2.38	★★★ 56	.95	★★★ 66	.56
45	2.19	57	.92	★★★ 67	.53
46	1.99	★ 58	.90	★★★ 68	.50
47	1.94	★★★ 59	.85	★★★ 69	.45
48	1.78	★ 59A	.81	★★★ 70	.40
49	1.61	★ 60	.79	★★★ 71	.37
★★★ 50	1.45	★ 61	.75	★ 71A	.25
★★ 51	1.40	★★★ 62	.74	★★★ 72	.34
★★ 52	1.25	★★★ 63	.71	★ 72A	.21
★★★ 53	1.09	★★★ 63A	.66	★ 73	.31
★★ 54	1.04	★★★ 64	.63	★ 73A	.16

ROUND FACE HOLE PUNCHES

<i>Punch No.</i>	<i>Hole Diam.</i>	<i>Punch No.</i>	<i>Hole Diam.</i>	<i>Punch No.</i>	<i>Hole Diam.</i>
74	2.38	★★★ 86	.95	★★★ 96	.56
75	2.19	87	.92	★★★ 97	.53
76	1.99	★ 88	.90	★★★ 98	.50
77	1.94	★★★ 89	.85	★★★ 99	.45
78	1.78	★ 89A	.81	★★★ 100	.40
79	1.61	★ 90	.79	★★★ 101	.37
★★★ 80	1.45	★ 91	.75	★ 101A	.25
★★ 81	1.40	★★★ 92	.74	★★★ 102	.34
★★ 82	1.25	★★★ 93	.71	★ 102A	.21
★★★ 83	1.09	★★★ 93A	.66	★★★ 103	.31
★★ 84	1.04	★★★ 94	.63	★ 103A	.16
★★★ 85	.97	★★★ 95	.60		

For description and use, see pages 12 to 17

FLAT FACE SOLID PUNCHES

<i>Punch No.</i>	<i>End Diam.</i>	<i>Punch No.</i>	<i>End Diam.</i>	<i>Punch No.</i>	<i>End Diam.</i>
104	4.10	107	2.73	★★★110	1.48
105	3.76	★★★108	2.23	★★★11199
★★★106	3.23	109	1.76	★★★111A89

ROUND FACE SOLID PUNCHES

<i>Punch No.</i>	<i>End Diam.</i>	<i>Punch No.</i>	<i>End Diam.</i>	<i>Punch No.</i>	<i>End Diam.</i>
112	4.10	★★★115	2.73	★★★118	1.48
113	3.76	★★★116	2.23	★★★11999
114	3.23	★★★117	1.76	★★★119A84

SCREW KNOCKING PUNCHES

<i>Punch No.</i>	<i>End Diam.</i>
★★★12176
★★★12225

PALLET ARBOR PUNCHES

<i>Punch No.</i>	<i>Inside hole diam.</i>	<i>Outside hole diam.</i>
13115	.31
13215	.37
13315	.41

SPECIAL NOTE: There is an exact difference of 30 numbers between equivalent sizes of Round Face Hole punches and Flat Face Hole punches. This information will be useful when staking staffs, when, for example, you would use a #69 Flat Face Hole punch after using a #99 Round Face Hole punch.



All starred numbers (1, 2 or 3) denote punches in 18R, 18L, and 18B Staking Sets. Two or three starred numbers denote punches in 601, 601R and 601L Staking Sets. Three starred numbers only denote punches in 600 Staking Sets.



STUMPS



All measurements in mm

Flat face solid

Used for closing holes in conjunction with round-face solid punches, peening, etc.

No.	Outside diam.	No.	Outside diam.	No.	Outside diam.
1	9.52	9	2.94	17	1.40
2	7.15	10	2.80	18	1.32
3	5.78	11	2.49	19	1.18
4	4.80	12	2.37	20	1.07
5	4.08	13	2.08	21	1.02
6	3.80	14	1.93	22	.87
7	3.57	15	1.78	23	.94
8	3.26	16	1.61	24	.84



Round face solid

Used in conjunction with round or flat-face solid punches for closing holes, etc.

No.	Outside diam.	No.	Outside diam.	No.	Outside diam.
25	5.78	32	2.37	39	1.18
26	4.80	33	2.08	40	1.07
27	4.08	34	1.93	41	1.02
28	3.80	35	1.78	42	.87
29	3.26	36	1.61	43	.94
30	2.80	37	1.40	44	.84
31	2.49	38	1.32		



Flat face hole

Used for resting wheels for driving out staffs, pinions, etc.

No.	Hole diam.	Outside diam.	No.	Hole diam.	Outside diam.	No.	Hole diam.	Outside diam.
45	2.58	5.79	56	1.18	4.80	67	.57	3.26
46	2.49	5.79	57	1.07	4.62	68	.53	3.26
47	2.38	5.79	58	1.02	4.49	69	.51	3.26
48	2.19	5.31	59	.97	4.31	70	.46	3.26
49	2.06	5.18	60	.92	4.08	71	.41	3.26
50	1.93	5.18	61	.84	3.98	72	.92	4.08
51	1.93	3.74	62	.79	3.86	73	.64	3.26
52	1.78	5.05	63	.71	3.73	74	.51	3.26
53	1.61	5.05	64	.66	3.57	75	.37	3.26
54	1.51	3.26	65	.64	3.26			
55	1.40	4.91	66	.61	3.26			



Roller stumps, driving on

Has central hole to receive staff and side groove for roller pin.

No.	Size
76	Pocket, Large
77	Pocket, Small
78	Bracelet, Large
79	Bracelet, Small





STUMPS



All measurements in mm

Roller stumps, removing

For two-arm balances; has transverse slot to receive balance arm and notch for end of roller pin if it projects.

No.	Size
80	Large, with slot for roller pin
81	Medium, with slot for roller pin
82	Small, with slot for roller pin
83	Very Small, without slot

Large flat face cup No. 87

Used for bumping plates or bridges end-shaking barrel arbors, etc.

Center arbor support stumps,

No. 88 Large
No. 89 Small

For supporting back end of center arbor, while staking on hands or cannon pinion.

Crotch No. 90

For supporting cannon pinion while adjusting setting friction.

For driving in Waltham detachable staffs

No.	Size	Hole diam.	Outside diam.
92	16s94	5.61
93	12s74	5.31
94	0s61	4.92

For driving out Waltham detachable staffs

No.	Size	
95	16s	Taper Mouth
96	12s	Taper Mouth
97	0s	Taper Mouth

For staking Elgin staffs

No.	Hole diam.	Outside diam.
99	1.50	5.79
99A89	5.79

Vee slot No. 100

For driving out escape pinions without disturbing wheel bushing, etc. Very practical and useful.

K&D**PUNCHES****K&D**

Set punch No. 1

- for centering the dieplate

Any other use would soon ruin the set punch, the point being very accurately ground.

K&D

Cross hole punches No. 7 to 11

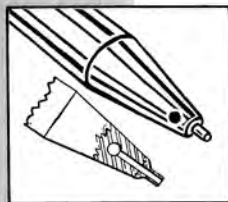

- for driving in and out staffs from rollers
- for driving in and out friction staffs (except Waltham, see punches 39 to 42)

The hole is shaped so that the punch rests on the shoulder of a cone-shaped pivot. The hole in the side is for observation and to facilitate the removal of a pivot that might become broken and lodged in the hole. Care must be taken in selection of the correct hole size so that the punch fits the pivot snugly, but not tight.

K&D

Punch with centered end No. 11A

- for driving out broken staffs

Saves the more delicate cross hole punches.





Triangular pointed punch No. 12

- for tightening roller tables

Raises three slight burs equidistant about the hole of a roller. Actually, an emergency measure when a proper fitting roller or staff cannot be obtained.



Prick punch No. 13

- for marking centers

Has stronger point than set punch and can be used to mark or nick.

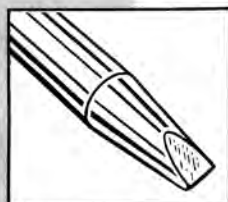

Stretching and peening punches Nos. 14 and 15

- for stretching balance arms
- for stretching metal

After removing the roller and hairspring, place the balance in the hole of a flat faced hole stump or punch which can be inverted to act as a stump. The hole should be just large enough to accommodate the hairspring shoulder of the staff snugly but not tight. Place the peening punch on the balance arm close to the staff and tap the punch with a series of light blows. The result should be checked often as overstretching is difficult to correct.

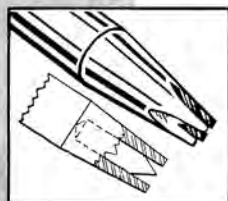

Center wheel punches Nos. 16, 17 and 18

- for indenting the rivetting of safety pinion staffs

The safety pinion staffs may slip in the center wheels of 18s Waltham watches, and others using this feature. To secure the staff to the wheel firmly these punches are used to indent the rivetting of the staff in four places with one blow.

Roller punches Nos. 19 to 22

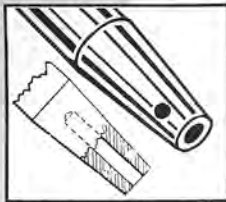

- for staking double rollers
- for staking Incabloc rollers
- Punches 20A and 21A are specifically for Incabloc rollers and are shaped to fit the groove in the bottom of the roller

All the punches are used to drive the roller on the staff and should be selected so that the hole will be large enough to go over the roller shoulder of the staff, but small enough to rest on the small roller table.

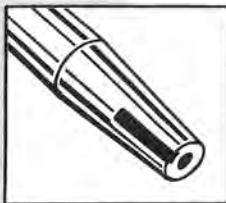

K&D

Roller staking punches Nos. 23 to 26C

- for driving single or impulse double rollers on balance staffs

These punches are made with a hole in the center to go over the balance staff and a groove in the side to receive and protect the roller jewel. Care should be used in selecting the proper punch to avoid the possibility of creating pressure on the roller jewel causing it to break or loosen. Some watchmakers prefer to use these punches inverted in the frame allowing the roller to rest on the top of the punch and driving the staff down into the roller with a flat face hole punch selected to fit over the collet shoulder of the staff. You can also reverse the procedure by placing the balance wheel over a flat face hole stump and driving the roller down on the staff using a roller staking punch.

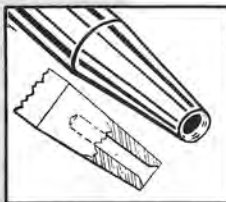

K&D

Collet closing punches Nos. 27 and 28

- for closing hairspring collets

Breguet collets should be closed from the top side and flat collets from the bottom to obtain the maximum clearance between the punch and the hairspring. The collet can only be closed to a point where the sides of the slot touch each other and if this is not sufficient, the collet or the balance staff should be changed. Be careful to select the proper size punch as one that is too large will shear off the hairspring after a few taps of your hammer. Always use these punches in the Staking Tool frame and rest the collet on a solid face stump.

Taper mouth closing punches**Nos. 29 to 38A**

- for closing holes in sockets of hour and second hands
- for spreading friction fit jewel settings or bushings
- for closing tips of sleeves

Taper mouth hole closing punches have the effect of gathering in and condensing stock which is in most instances a post, socket or bushing.

Perhaps the most common use of this punch is to close the hole in hour hands which is accomplished by first placing the hand on a flat face stump with the socket in an upright position. Select a taper mouth punch which fits over the socket and will not touch the body of the hand. Tap the punch lightly with a brass hammer turning it about one quarter of a turn after each blow.

These punches are also ideal for spreading friction fit jewel settings such as used by Waltham. To spread a jewel setting, select a punch slightly smaller than the setting itself. Place the setting on a flat face stump and center with the taper mouth punch. Light tapping will create a ridge or groove and spread the setting just enough to afford a tight fit.



K&D

Driving out punch No. 39

- for removing Waltham detachable staffs

This punch is used in conjunction with stumps 95, 96 and 97. The hub of the balance wheel fits into the tapered hole of the stump. The punch has a tapered hole to fit on the pivot of the staff. A few light taps are sufficient to drive out the staff.

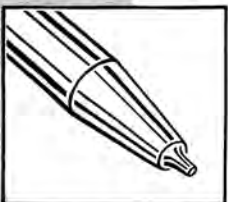

K&D

Driving in punches Nos. 40 to 42

- for staking Waltham detachable staffs

These punches are used in conjunction with stumps 92, 93 and 94. A stump is selected with a hole large enough to accommodate the hairspring shoulder of the staff and the balance is inverted on the stump. A punch is selected which will go over the roller shoulder of the staff and seat itself against the hub. A few light taps are sufficient to drive in the staff.

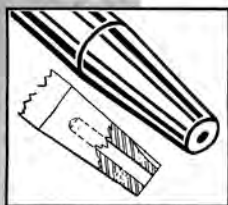
Flat face hole punches Nos. 43 to 73A

- for final staking of balance staffs
- for final staking of train pinions
- for pressing hairspring collets on balance wheels
- for use as stumps when inverted into the staking tools. Ideal for riveting "hard" staffs — will save wear and tear on the expensive dieplate.

When used for final staking of a balance staff or pinion, it is important to select the correct size punch for doing a good job and avoiding damage to the punch. A proper fitting punch should fit freely over the collet hub with a clearance of about .02 to .03 mm. Always tap the punch lightly with a brass hammer turning it about one quarter of a turn after each blow.

If you select too large a punch, it is possible that you may not obtain the full degree of bearing surface, thereby, placing too much pressure on the inside corner of the punch causing it to flatten out or chip. If you select too small a punch, the staff becomes a wedge and will split the punch or round the inside corners of the punch.

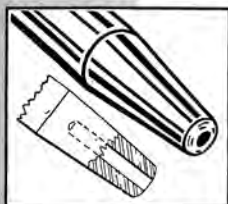
**Round face hole punches Nos. 74 to 103A**

- for spreading undercut of staffs and pinions prior to finishing with a flat face hole punch

Before using this style punch, press the balance wheel firmly over the riveting surface with a flat faced hole punch. Make sure that the shoulder of the staff extends far enough through the wheel to provide sufficient stock to form a rivet. Select the correct size punch in the same manner as with the flat faced hole punches.

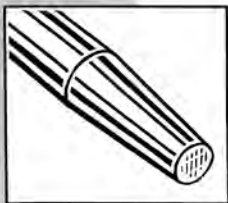
**Flat face solid punches Nos. 104 to 111A**

- for closing holes
- for adjusting end shake of train bushings
- for riveting where a hole punch is not required
- for use as stumps when inverted in Staking Tool frame

Round face solid punches

Nos. 112 to 119A

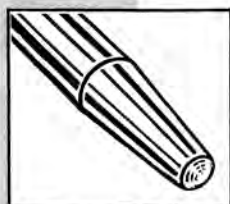

- for closing pivot holes
- for closing minute hand holes
- for burnishing top of old style jewel settings after closing bezel
- for closing holes in rollers

The above punches are generally used in conjunction with a solid face stump and their high polish will leave a fine finish on oil cups or pivot holes. When using to close minute hand holes, always use a Staking Tool frame and avoid direct contact with the dieplate by first placing the hand on a solid face stump. If the hole cannot be closed easily with light tapping, the material is too hard and should have the temper drawn to avoid breakage.

These punches were not designed to be used on clock plates.



Screw knocking punches

Nos. 121 and 122



- for driving out screws which have broken in the plates
- for driving out friction banking pins

Care must be used with these punches or breakage can be expected. In driving out a broken screw, one good blow is much better than a succession of light blows and less likely to break the punch.



Pallet Arbor punches Nos. 131 to 133

- for staking friction pallet arbors

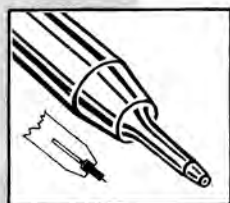

These punches have a specially designed double shoulder hole which accommodates both the pivot and part of the body of the pallet arbor. The inside shoulder of the punch rests on the shoulder of the pallet arbor. A drop of oil in the hole of the punch will keep the pallet arbor from falling out of the punch.

HOW TO USE



STAKING TOOL

ATTACHMENTS



BALANCE STAFF REMOVER

With this tool staffs can be extracted quickly and efficiently. The balance arms are protected against distortion and splitting.

Before using the tool select a hole in the dieplate of the staking tool frame which fits over the hub of the staff closely. Center the hole with the centering punch and place the staff in the hole so that the balance arms rest on the dieplate.

The remover is then placed over the balance as shown in the illustration. The hole in the bottom of the remover fits over the hairspring shoulder of the staff. Pass the extracting punch through the staking tool frame and remover so that it rests on the pivot of the staff.

Turn the upper knurled sleeve counter-clockwise so that it moves upward against the staking tool arm. The stop arm of the tool will swing against the body of the staking tool and prevent the body of the tool from turning. Tighten the sleeve just enough so that the remover sits firmly in the staking tool frame.

Strike the punch a sharp blow with a brass hammer and the staff will come through the hole in the dieplate.

To select the proper remover for your staking tool, measure the opening in the frame and subtract approximately $3/16$ ". The removers are supplied in five sizes: $5/8$ ", $3/4$ ", $7/8$ ", 1" and $1\frac{1}{8}$ ".

No. 50 for Pocket Watches, specify size for correct opening.

No. 50B for Bracelet and Baguette Watches, specify size for correct opening.



ADJUSTABLE ROLLER REMOVERS

The tool fits in the dieplate of the staking tool and the bent arm fits into one of the die holes, or the center hole in the dieplate. The balance, with the roller attached, should be inverted, and slipped in between the jaws, so that the jaws come between the balance hub and the top of the roller table. The gap in the jaws is adjusted between punches, the balance is tapped

by turning the knurled collet. Using one of the roller remover lightly, and the roller will slip off the balance staff shoulder.

No. 317 set contains 3 cross hole punches and 2 adjustable stumps



ADJUSTABLE ROLLER REMOVER STUMPS

Used in the same manner as No. 317 set. Punches are not provided in these sets.

No. 305B for baguette and bracelet watches
No. 305C for pocket watches

K&D

PUNCHES AND STUMPS FOR INCABLOC ROLLERS

Set contains punches 20A and 21A and stumps 62 and 67. Used as described under punches 19 to 22.

No. 329 set contains 2 punches and 2 stumps



K&D

CANNON PINION CLOSING PUNCH AND STUMP



Stump is slotted to hold cannon pinion, and punch is shaped like a wedge. Select hole in dieplate in which stump will fit and center. Cannon pinion is placed in slot of stump, and punch is passed from the staking tool arm over the cannon pinion. Light taps will dent the cannon pinion which will tighten the cannon pinion on the center wheel staff.

No. 323 for pocket watches

No. 323B for bracelet and baguette watches

K&D

HOLDER AND SUB PUNCHES

For driving out screws which have been broken in watch plates, etc. The sub-punches are held in holder with knurled nut, so they cannot fall out, but can be readily withdrawn when broken. Sub-punches are graduated in size.

No. 316 set contains 10 sub punches and 1 holder

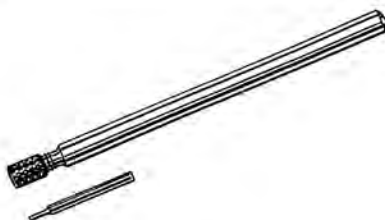

K&D

PUNCHES FOR PALLET ARBORS

Set contains punches 131, 132 and 133. Used as described under punches 131 to 132.

No. 331 set of 3 punches

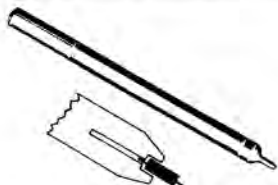



FRICION JEWELLING ACCESSORIES

FRICION JEWELLING ATTACHMENTS

FOR OLD STYLE FRAMES

Lever type with micrometer stop that reads to 1/100 mm. Can be fitted to all K&D frames except the smaller type, such as 5B and 504 and the new 18B frames.

No. 540 style as illustrated on this page

FOR 18B FRAMES

Lever type with micrometer stop that reads to 1/100 mm. Two styles of micrometer stops are available for 18B frames. 18B's with frame numbers starting with "S" use the style as shown on 18R set on following pages. Other frame numbers use micrometer stop like shown on 540 attachment.

No. 540S attachment for 18B frames with numbers starting with "S"

No. 540R attachment for other 18B frames

FITTING ATTACHMENTS

Frame must be sent to factory to fit 540 and 540R attachments. No. 540S attachment can be easily fitted by a watchmaker.



18X COMBINATION SETS

These combinations convert your K&D staking tool to friction jewelling and consist of:

Large deluxe box . . .

- No. 540, 540R or 540S attachment
- No. 322B—set of 18 reamers in holder
- No. 321 —set of 7 pushers and holder
- No. 324 —set of 6 friction jewelling stumps
- No. 130 —cone miller
- Friction jewelling attachments 540 or 540R are fitted to your present K&D frame . . .

No. 18X — combination with 540 attachment

No. 18X — combination with 540R attachment

No. 18X — combination with 540S attachment

No. 322B SET OF 18 REAMERS AND HOLDER

The reamers are numbered to correspond with jewel sizes, although they measure .01 mm. smaller, so that the jewel will fit snugly, i.e., a #6 reamer actually measures .59 mm. Reamers fit into holder friction tight, and can be removed easily by inserting small pin through cross hole.



No. 321 SET OF 7 PUSHERS AND HOLDER

Pushers are concave and graduated in size to cover the full range of jewels.



No. 324 SET OF 6 FRICTION JEWELLING STUMPS

Have holes, which are graduated in size, to accommodate reamers.



No. 130 CONE MILLER

Used to remove any burs from jewel settings.



No. 330 FACE PLATE

For holding tiny bridges, jewel settings, etc., while reaming out holes and setting friction jewels. Set consists of: 5 clamps; 2 short screws with spring, for use with clamps directly on dieplate; 2 long screws with spring, for use with clamps on stump surface.

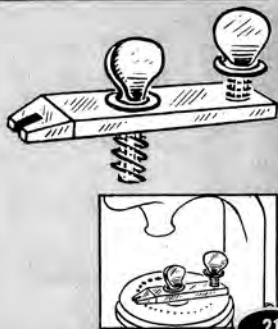

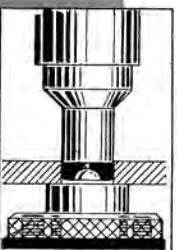
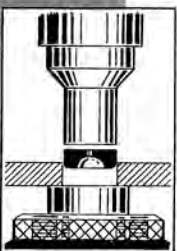
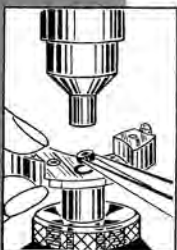
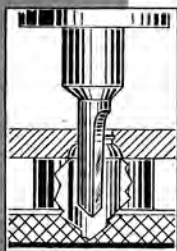
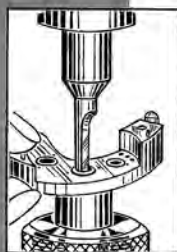

STEPS IN FRICTION JEWELLING

- 1—Select a jewelling stump that has a hole larger than the diameter of the jewel to be replaced. Place the stump in the dieplate of the staking tool frame and center.
- 2—Select a pusher that is slightly smaller than the diameter of the jewel to be replaced. Place in holder and pass through staking tool head.
- 3—Except when setting balance jewels, place watch plate or bridge on stump with inside of plate facing up. When setting balance jewels, outside of plate or bridge faces up. Rest pusher on old jewel, and adjust micrometer stop so that this will be the limit of the movement of the pusher. This is done so that the new jewel will be pressed into the same depth as the old one. **Note reading on micrometer stop.**
- 4—Lower micrometer stop, and press out old jewel.
- 5—If the old jewel was a friction jewel, and side of hole is in good condition, steps 6 and 7 may be eliminated. Simply measure hole by using reamer, and proceed to step 8.
- 6—If hole is to be refinished, select a reamer that is slightly larger than the old hole, put in holder, and pass through staking tool head.
- 7—Turn reamer holder and ream out new hole, running reamer through plate or setting and beyond, so that approximately .5 to 1.0 mm. of the shoulder of the reamer enters the hole. Withdraw reamer and holder from staking tool frame.
- 8—The cone miller is then used to remove burrs from around the edges of the hole.
- 9—Place jewel in reamed out hole with oil cup facing down.
- 10—Put pusher and holder back in staking tool head, reset micrometer stop to reading noted in step 3, and rest pusher on new jewel.
- 11—Press lever gently, but, firmly to force the jewel into the hole. Micrometer stop will prevent lever from pressing jewel further than necessary.
- 12—If, after checking end shake, the jewel needs to be reset higher or lower in the plate, adjust micrometer stop, and press jewel.

K&D

K&D JEWELLING CLAMPS HOLD TINY BRIDGES AND JEWEL SETTINGS

Large plates and bridges can be held with fingers while reaming and pressing in jewels. Settings and bridges which are too small to be held securely in fingers should be held with clamps supplied in set No. 330.

K&D

When friction fit jewel settings are loose in plates or bridges, tighten before attempting to set jewels. See instructions on use of Taper Mouth Closing Punches #29 to 38A.

K&D STAKING TOOLS K&D

Save dollars . . . save hours every day with a K & D staking tool, the choice of discriminating watchmakers.

INVERTO DELUXE-No. 18L

CONTAINS

- 100 specially selected punches for modern watches
- 20 selected stumps
- complete Friction Jeweling Attachment including 18 reamers and holder, 7 sub punches and holder, 6 graduated flat face hollow stumps
- 28 holes in the die-plate

No. 18L. In Mahogany Box; Blond Basswood on Request.



INVERTO DELUXE-No. 18R

Contains all the features of No. 18L above plus . . .

- 2 balance staff removers for large and small watches
- 2 adjustable roller remover stumps
- 2 sets cannon pinion closing punches and stumps
- 10 sub punches and holder for driving out screws and similar work

No. 18R. In Mahogany Box; Blond Basswood on Request



INVERTO-No. 18B

(same frame as the 18R without the friction jewel attachment)

- Contains: 100 specially selected punches for modern watches
- 20 selected stumps
 - adjustable roller remover stumps
 - 10 sub punches for driving out screws and similar work
 - 28 holes in the die-plate.

(This set can be easily converted for Friction Jeweling)



No. 18B. In Mahogany Box; Blond Basswood on Request.

Junior INVERTO 600 Series

Lighter than regular Inverto and with smaller die plate, containing 26 holes. In mahogany box; blonde basswood on request.

No.	Punches	Stumps
600	60	20
601	80	20
602	100	20
610*	120	20

*Furnished in 18B Inverto Box

600 "R" SERIES

Furnished with complete Friction Jeweling Attachments, 2 Balance Staff Removers, 2 Adjustable Roller Remover Stumps, 2 sets of Cannon Pinion Closing Punches and Stumps, set of 10 sub punches for driving out screws, and DeLuxe Box (like 18R).

No.	Punches	Stumps
600R	60	20
601R	80	20
602R	100	20
610R	120	20

600 "L" SERIES

Furnished with complete Friction Jeweling Attachments and DeLuxe Box (like 18R).

No.	Punches	Stumps
600L	60	20
601L	80	20
602L	100	20
610L	120	20



STAKING TOOLS

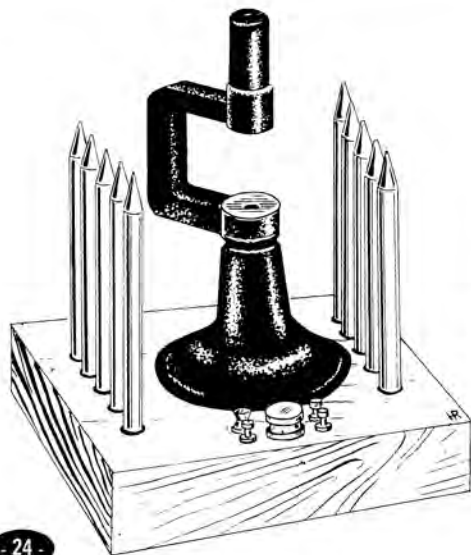

MIDGET STAKING TOOL

Keep this K&D MIDGET staking set handy on your bench for instant use. Made according to the same exacting standards of precision as the larger K&D sets, the crackle-finish frame takes regular K&D punches and stumps. Complete with 10 punches and 5 stumps mounted on wood base.

No. 906. With 10 punches and 5 stumps



HARDENED STEEL ANVILS AND BENCH BLOCKS



No. 1085A

This block is hexagonal in shape with 16 well graduated holes. One hole will accommodate K&D staking tool stumps. Four milled slots allow for a wide variety of exacting jobs. The top, bottom, and sides have been ground flat and smooth. The block has been case hardened by cyaniding for correct hardness. The distance across the points is approximately $1\frac{1}{8}$ inches and $\frac{3}{4}$ inches high.



No. 1086A



This hardened steel anvil has four milled slots, and features a "V" slot. This slot is useful in removing pinions and other such objects. There are nine graduated holes with the largest hole being sized for K&D staking tool stumps. The top and bottom have been machine ground with the sides polished. The anvil measures approximately $1\frac{3}{4}$ inches in length, and is $\frac{3}{4}$ inches high.

No. 1088

This hardened steel block measures $2\frac{1}{2}$ inches square by $\frac{3}{4}$ inches high. Both top and bottom have been machine ground to a smooth mirror surface. A useful tool for the flattening of many objects and other jobs as the working area is ample in size. This block along with other K&D blocks and anvils can be supplied in either a bright nickel or chrome finish at an extra charge.



No. 1087A

This hexagonal block measures approximately $3\frac{1}{2}$ inches across the points and is $1\frac{1}{2}$ inches high. The bottom has been recessed to lighten the weight. Nine holes are graduated from $\frac{1}{8}$ to $\frac{5}{8}$ inches in diameter. Being hexagonal in shape this block can be easily held in vises for the purpose of drilling, driving in pins, etc. The "V" groove can be handy for various jobs. The sides are polished and the top and bottom machine ground.

No. 1089

This anvil measures approximately $1\frac{3}{4}$ inches across the points and $\frac{3}{4}$ inches high. The block has been case hardened by cyaniding to a correct depth as are all K&D blocks. Because of its size, it can be held by small bench vises for many useful purposes.



No. 1090



"JIFFY STUMP BLOCK" . . . hardened and machined on both sides . . . has holes for 7 stumps, making it convenient when the staking tool itself is not needed, and saving wear and tear on the die plate. This block accommodates Roller Remover Stumps nos. 305B and 305C in a special large hole, which (together with the drilled and tapped center hole) also takes the Jewelrying Clamps no. 330.

FRICITION CHUCK SCREWDRIVERS

These screwdrivers have double end interchangeable blades held by friction chucks; chrome plated handles with colored heads for easy identification.

No. 279. Set of 9 covers entire range for watch work from smallest jewel screws on up. Blade sizes .092" - .070" - .055" - .041" - .035" - .030" - .027" - .020" - .030" - .016"

No. 289. Set of 6 with Blade sizes .092" - .070" - .055" - .041" - .035" - .030"

No. 249. Set of 3. Jewel screwdrivers. Blade sizes .039" - .033" - .027"

No. 249A. 1 Jewel screwdriver. Blade size .027"

No. 289A. 1 Jewel screwdriver. Blade size .115"

No. 249B. Set of 5. Jewel screwdrivers. Blade sizes .039" - .033" - .027" - .020" - .016"

No. 249J. Set of 3. Jewel screwdrivers. Blade sizes .027" - .020" - .016"

SCREW CHUCK SCREWDRIVERS

The double end interchangeable blades and the sure tightening of the screw chuck make this the finest set of watchmakers screwdrivers obtainable. Chrome plated handles with colored heads for easy identification of sizes. Set of 6. Blade sizes .100" - .080" - .070" - .055" - .040" - .025"

No. 293. Set of 6

SOLID CHUCK SCREWDRIVERS

Reversible double end blades held in solid chuck. Chrome plated handles with colored heads for easy identification of sizes. Set of 6. Blade sizes .100" - .080" - .070" - .055" - .040" - .025"

No. 250. Set of 6

SCREWDRIVER BLADE SHARPENER

Watchmakers screwdriver blades can be sharpened easily by inserting in tool and rolling back and forth over stone. Screwdriver is held firmly by spring and can be set to any angle.

No. 461. Blade sharpener only

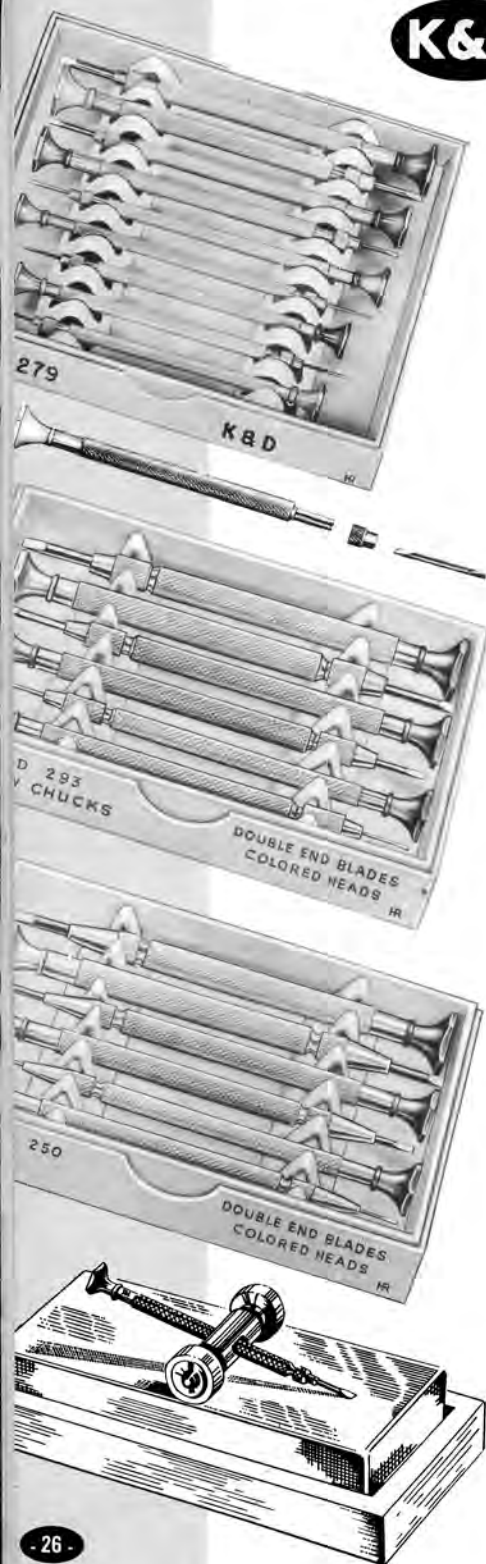

SCREWDRIVERS

K&D

BALANCE SCREWDRIVER AND HOLDER

Has screwdriver blade and three jaws to hold the balance screw; cannot slip. Jaws are opened and closed by pushing on head of handle. Chromium plated.

No. 427. Screwdriver and holder

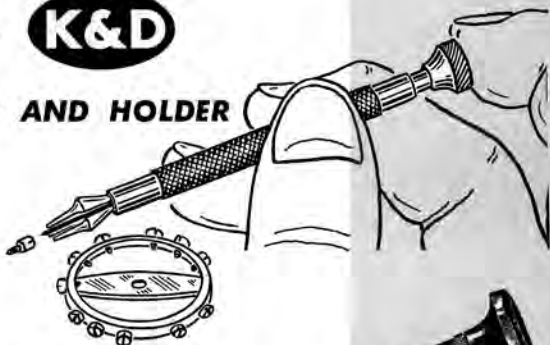

OPTICAL SCREWDRIVER AND HOLDER

Has self adjusting jaws and will hold the screw straight and securely while removing or replacing; screws will not get lost or threads stripped. Knurled gun metal handle, hexagon rubber head.

No. 443. Blade width .075"



OPTICAL SCREWDRIVER

Top fits palm of hand and rotates. Has chrome handle with interchangeable blade. Overall length 4 1/2".

No. 410. Blade .115
No. 410A. Blade .0937



"JERRY" SCREWDRIVER

Now you can take apart a movement in jig time with only ONE screwdriver. You press the top down and a small blade emerges (fig. 2) . . . perfect for plate screws, jewel screws, etc. For big screws like crown, ratchet wheel, case screws, etc., just press blade down on bench and "JERRY" returns to normal position (fig. 1). Both blades may be sharpened in normal position at one time.

No. 033. Two in one screwdriver

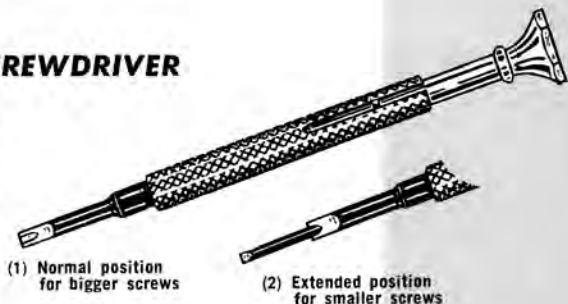

MAGNETIC SCREWDRIVER

The permanent magnet in the handle transfers its energy to the reversible blade to hold small ferrous screws, so they will not be dropped.

No. 412. Blade size .0625" on one side, .0937" on the other.

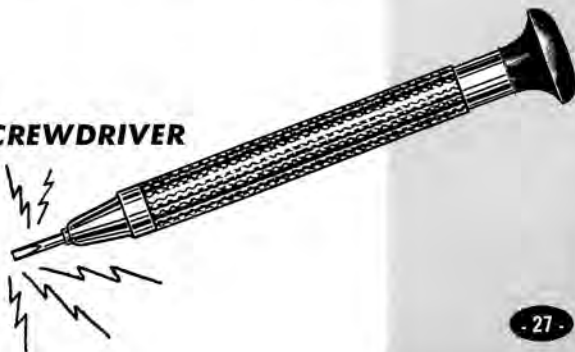



... protects
the
most
sensitive
mainspring

ADJUSTABLE BRACELET WINDERS

With this set of 3 adjustable winders, you can handle all sizes of mainsprings for wrist watches from baguette to 13 Ligne. By turning the lower portion of the knurled handle, you can adjust the winder to the exact size of the watch barrel. The push button in the handles push wound mainsprings into the watch barrel without distortion. These winders now feature the new safety hook on the arbor to prevent kinking of the most delicate mainsprings. Medium and large sizes have double end arbors and all are chrome plated.

- | | |
|--------------|---|
| No. 123 x 3. | Set of 3 consisting of 123, 123A and 123B in box. |
| No. 123B. | Small size. Range 4 to 6mm. |
| No. 123. | Medium size. Range 5 to 8mm. |
| No. 123A. | Large size. Range 8 to 11mm. |

BRACELET MAINSPRING WINDERS



Complete range of individual sizes for all wrist watches from baguette to 13 ligne. All have double end arbors and push button in handle to push the wound mainspring into the watch barrel without distortion. All are chrome plated and the arbors have the safety hook feature which prevents kinking of the most delicate mainsprings.

The new flanges for winding automatic bridles are also available for use on the winders in this set. The flanges fit over one of the double end arbors on 5 sizes which will cover all the automatic watches now on the market.

Both sets listed below come in the plastic box which will hold 9 winders.

- No. 117. Complete set of 9 winders.
- No. 118. Set of 5 most popular sizes which will take the new flanges for automatic bridles.

**SAFETY HOOK
FEATURE**

MAINSRING WINDERS **K&D**

FLANGES FOR WINDING AUTOMATIC WATCH BRIDLES

These flanges fit on the arbors of the winders in sets 117 and 118 so that bridles can be wound like mainsprings to prevent distortion. The 5 sizes were selected to cover the full range of bridles used in automatic watches.

No. 119. Set of 5 flanges

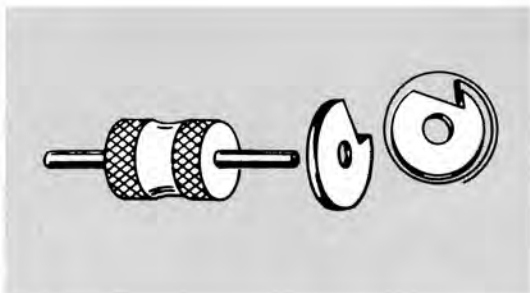

POCKET WATCH MAINSRING WINDERS

Modified Robbins winder which may be held by hand. Six barrels included covering the range from 7 to 16mm. Plunger in handle pushes mainspring to barrel without distortion.

No. 126. Winder and six barrels



POCKET WATCH WINDERS

Set contains 3 arbors and 9 barrels which cover the range from 7 to 16mm. This winder can be held in vise. Winder arbors are different sizes and can be removed from the frame by turning the knurled nut a half turn. The frame is chromium plated.

**No. 128. Winder plus 3 arbors
and 9 barrels**



The new safety hook on the arbor prevents kinking of the most delicate mainsprings, and makes it easy to "back off" after the spring is wound. The mainspring coils smoothly around the arbor without distortion and retains its original form.





LATHE MOTORS

Powerful, quiet running motors efficiently designed to run a jeweler's lathe.

- 1/15 H.P.
- Complete with foot rheostat control for speeds from 200 to 10,000 R.P.M.
- 110 Volts, AC or DC
- Reversing switch in base
- Three step cone pulley
- Weight 6½ pounds
- Double end shaft

No. 105C. Handsome chromium finish

No. 105J. Black art-crackle finish

POLISHING MOTOR

Rugged, variable speed motor for polishing, buffing and grinding. Double sealed ball bearings are lubricated for life and will not burn out under repeated loading. Mounted on rubber feet to be used portable or can be bolted to a bench. Comes complete with right hand and left hand taper spindles.



SPECIFICATIONS

- ⅛ h.p. at 5,000 r.p.m.'s under load
- Dial power rheostat provides for infinite speed control from 2,000 to 10,000 R.P.M. under load
- Uses 115 volt AC 60 cycle current
- 5/16" polished drill rod shaft
- Double sealed ball bearings

No. 155. Complete with right and left hand taper spindles

EQUIPMENT



DEMAGNETIZER

Double Form Var coil with aluminum cover, switch, four foot cord and detachable plug. For 110 volt A.C. current only. Base $3\frac{3}{8}$ " x $2\frac{1}{4}$ ".

No. 202. 110 volt A.C. current



DEMAGNETIZER

Economical model on wood base.

No. 60. 110 volt A.C. current



No more wearing an "armful of watches"

No more "comebacks"

when you test-wind automatics on a

Check-O-Matic

... test-winds automatic watches
by natural, gentle, "arm motion"

The natural arm motion of Check-O-Matic simulates normal conditions of wear so closely that if a watch would not wind properly on the wrist, it will not wind on the machine.

You can accommodate watches using either a 180° or 360° oscillation. For 360° , place one plug in the top well on the face-plate for 180° , place two plugs in side wells as shown in illustration. Only 15 minutes on the machine will fully wind any automatic. Check-O-Matic operates on standard 110 Volt alternating current. A flick of the finger on the front switch turns it on or off.



No. 252. Accommodates watches
using either 180°
or 360° oscillation

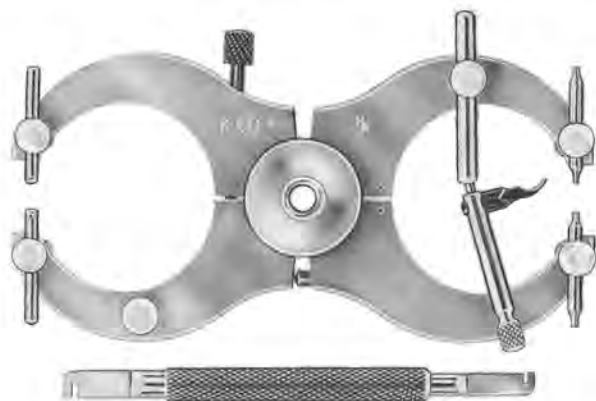

BALANCE TRUING AND POISING CALIPER

Has double end centers always capable of being set parallel. For bracelet and large watches. Includes truing wrench.

No. 404. Complete with truing wrench

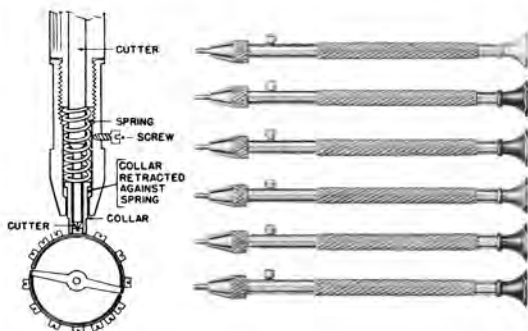

BALANCE SCREW CUTTERS

Cuts notch in top of balance screw without removing screw from balance wheel. Set of six takes all sizes from baguette to 18 size. Retractable collar automatically centers cutter when in use.

No. 525. Set of six

K&D FINE



SAW AND ARBOR

Small saw convenient for slotting screw heads and similar work. Arbor fits #38 wire chuck.

No. 76. Fits no. 38 wire chuck



JEWEL PUSHER

For removing old jewel settings and pushing in new settings. Six sizes mounted on aluminum center.

No. 44. Six sizes

PARALLEL CALIPERS

For balance truing and poising. Parallel guide pins assure accuracy. Chromium plated. Truing wrench included.

No. 405. For average size watches

No. 406. For small bracelet and baguette watches



RING CUTTER

For cutting rings while on finger. Easy, certain and rapid. Cutter entirely enclosed for protection. Satin chrome finish.

No. 100A. With replaceable saw



TOOLS **K&D**

CIRCULAR SAWS

Fits No. 76 arbor. Hole size .20". Available in diameters $\frac{1}{2}$ " - $\frac{5}{8}$ " - $\frac{3}{4}$ " - 1". In thicknesses .010" - .012" - .014" - .016" - .018"

No. 76A. Specify diameter and thickness



SLEEVE WRENCHES

Bits are carefully formed and electrically tempered for strength and toughness.

No. 145. 10 bits for bracelet and pocket watches

No. 148. 6 bits for bracelet watches

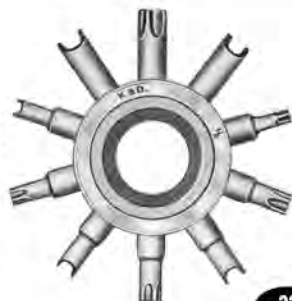



HAND REMOVERS

Quick acting tool for removing watch hands without marring dial. Just press down and hands come off. Plunger holds hands after removal.

No. 310A. Regular size
No. 310B. Bracelet size

K&D

QUALITY



PIN PUSHER

For removing spring bars, pin joints, etc. Made of tempered steel with hardwood handle.

No. 162. Length 5 3/8 inches.

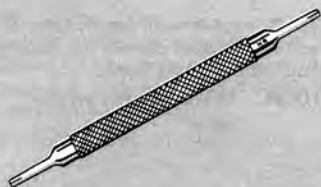

STEM REMOVERS

For getting short broken stems out of movements without disassembling watch. Set of three with different sizes of ends.

No. 450. Set of 3



HAIRSPRING COLLET REMOVERS

Finely tempered jaws. Knurled metal chrome handle.

No. 19. Large
No. 19 B Bracelet size

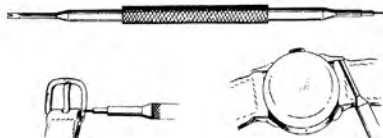

NEW SPRING BAR PUSHER

Specially designed to remove push-pins from any type of watch case or strap buckle. Made of the finest tempered steel for long wear. Ends are replaceable.

No. 365. With replaceable ends

TOOLS...

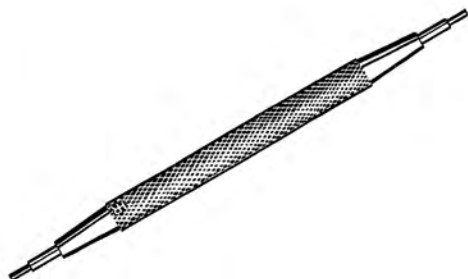

WATCH KEYS

Double end bench keys. Squares are all different sizes. Knurled chromium handles. Sets of three.

No. 63. Pocket
No. 63B. Bracelet

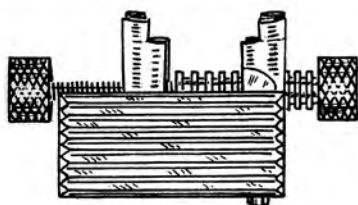

MOVEMENT HOLDER

Special device allows quick opening and closing from smallest to 12 ligne watches. When button underneath is resting on bench only the thumb screw will open and close jaws: when button is out jaws move freely. Jaws stay tightened when movement is in holder until loosened by thumb screw. A real timesaver.

No. 762. Timesaving tool



BENCH KNIFE

Well tempered blade holds keen edge. Flat side non-roll handle of black polished hardwood. Overall length 5", blade 1 3/4".

No. 98. Length 5", blade 1 3/4"



SOLID GOLD TIPPED OILER

10 Karat gold tip prevents corrosion. Handle neatly knurled with hexagonal piece to prevent rolling.

No. 67. 10 Karat gold tip

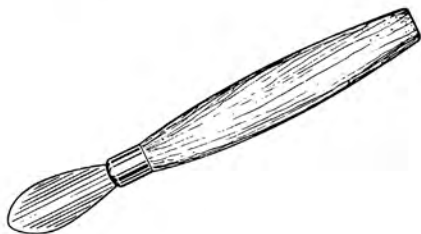

CASE OPENER

Fine rosewood handle, well finished, tempered steel blade, closed end ferrule with well rounded corners. Length 4 1/2". Superior quality.

No. 94. Length 4 1/2 inches

K&D TOOLS K&D

COUNTERBORES AND COUNTERSINKS

For standard machine screws. Made of quick cutting carbon steel. In box with wood stand.

SET OF 12

Filister heads nos. 2-4-6-8

-10-12-14

Flat head nos. 2-4-6-8-10

No. 221. Set of 12

SET OF 16

Filister head nos. 2-3-4-5

-6-7-8-9-10-12-14

Flat head nos. 2-4-6-8-10

No. 221A. Set of 16

SET OF 4

Filister head nos. 0 and 1, Flat head nos. 0 and 1

No. 222. Set of 4

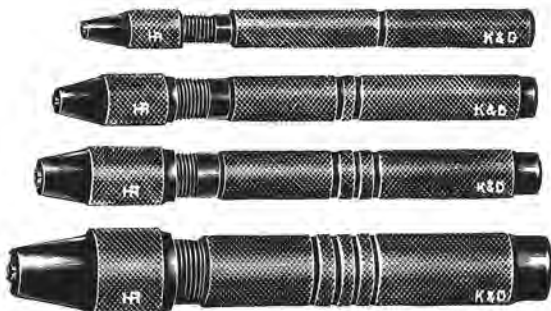

PIN VISES

All steel with hollow handles — tempered steel jaws. Superior quality — chromium plated.

Number	Range
211A	.0 to .040"
211B	.025 to .062"
211C	.050 to .125"
211D	.115 to .188"
211x4	Set of all four

BRASS HEAD HAMMER

Especially designed for staking tools. Brass head will not mar punches. Just the right amount of spring in the handle. Head is 2" long, weight 2½ oz.

No. 91. 2½ oz., head 2" long



FIBRE AND BRASS FACE HAMMERS

Detachable brass and fibre faces. Wrench included for removing faces. Neat wood handle.

No. 92. 2½ oz., head 2" long

No. 93. 5 oz., head 2 5/8" long



NYLON AND BRASS FACE HAMMERS

Detachable brass and tough nylon faces, wrench included, for removing faces. Neat wood handle.

No. 92N. 2½ oz., head 2" long

No. 93N. 5 oz., head 2 5/8" long





**where
watchmaking
results count...
you'll find**



**fine tools
since 1876**

